

US00D656840S

(12) **United States Design Patent**  
**Tacconi et al.**

(10) **Patent No.:** **US D656,840 S**  
(45) **Date of Patent:** **\*\* Apr. 3, 2012**

(54) **BOTTLE**

(75) Inventors: **Alice Tacconi**, Milan (IT); **Mirco Onesti**, Milan (IT); **Gustavo Messias**, Milan (IT)

(73) Assignee: **Ansell Limited**, Richmond, Vistoria (AU)

(\*\*) **Term:** **14 Years**

(21) **Appl. No.:** **29/363,572**

(22) **Filed:** **Jun. 11, 2010**

(51) **LOC (9) Cl.** ..... **09-01**

(52) **U.S. Cl.** ..... **D9/689**; D9/504; D9/529; D9/532; D9/443

(58) **Field of Classification Search** ..... D9/682, D9/685-691, 516, 529, 531-532, 537-40, D9/545, 49, 558, 435, 439-440, 443, 448-450, D9/454; 220/660, 662, 669, 675  
See application file for complete search history.

(56) **References Cited**

**U.S. PATENT DOCUMENTS**

D165,653 S *	1/1952	Johnson	.....	D9/443 X
D189,374 S *	11/1960	Harris	.....	D9/504
D189,406 S *	12/1960	Harlow	.....	D9/443
3,119,541 A *	1/1964	Lynn	.....	220/212.5 X
3,180,528 A *	4/1965	Balint et al.	.....	222/105
4,101,042 A *	7/1978	Strong et al.	.....	215/11.1
D254,163 S *	2/1980	Sidor	.....	D9/535
D287,211 S	12/1986	Weiss	.....	
D307,552 S *	5/1990	Pakzad	.....	D9/535
D322,392 S *	12/1991	Schneider et al.	.....	D9/689
D458,134 S *	6/2002	Berish et al.	.....	D9/443
D476,231 S *	6/2003	Paquette	.....	D24/194 X
D480,955 S *	10/2003	Perlowski et al.	.....	D9/521
D482,607 S *	11/2003	McRae	.....	D9/443 X

D521,386 S *	5/2006	Priestman	.....	D9/529
D525,133 S *	7/2006	Zeh et al.	.....	D9/516
D525,871 S *	8/2006	Zeh et al.	.....	D9/521
D542,665 S *	5/2007	Poe, II	.....	D9/529
D572,585 S *	7/2008	Perrin et al.	.....	D9/443
D575,157 S *	8/2008	Jaketic	.....	D9/516
D605,945 S	12/2009	Macaulay et al.	.....	
D610,459 S *	2/2010	Nagata	.....	D9/521 X
D613,174 S *	4/2010	Pecora	.....	D9/529
D615,874 S *	5/2010	Nagata	.....	D9/689
D616,744 S *	6/2010	Cresswell et al.	.....	D9/443
D635,457 S *	4/2011	Lane	.....	D9/503
D647,407 S *	10/2011	Toh et al.	.....	D9/688
D647,806 S *	11/2011	Toh et al.	.....	D9/688

**OTHER PUBLICATIONS**

“European Registered Community Design No. 000738802-0001”, Jun. 12, 2007, 3.

\* cited by examiner

*Primary Examiner* — Carol P Rademaker

(74) *Attorney, Agent, or Firm* — Moser Taboada

(57) **CLAIM**

The ornamental design for a bottle, substantially as shown and described.

**DESCRIPTION**

FIG. 1 is a top, front, right perspective view of a bottle embodying the new design;  
FIG. 2 is a bottom, front, right perspective view thereof;  
FIG. 3 is a top plan view thereof;  
FIG. 4 is a front elevational view thereof;  
FIG. 5 is a left side elevational view thereof;  
FIG. 6 is a right side elevational view thereof;  
FIG. 7 is a rear elevational view thereof; and,  
FIG. 8 is a bottom plan view thereof.

**1 Claim, 4 Drawing Sheets**

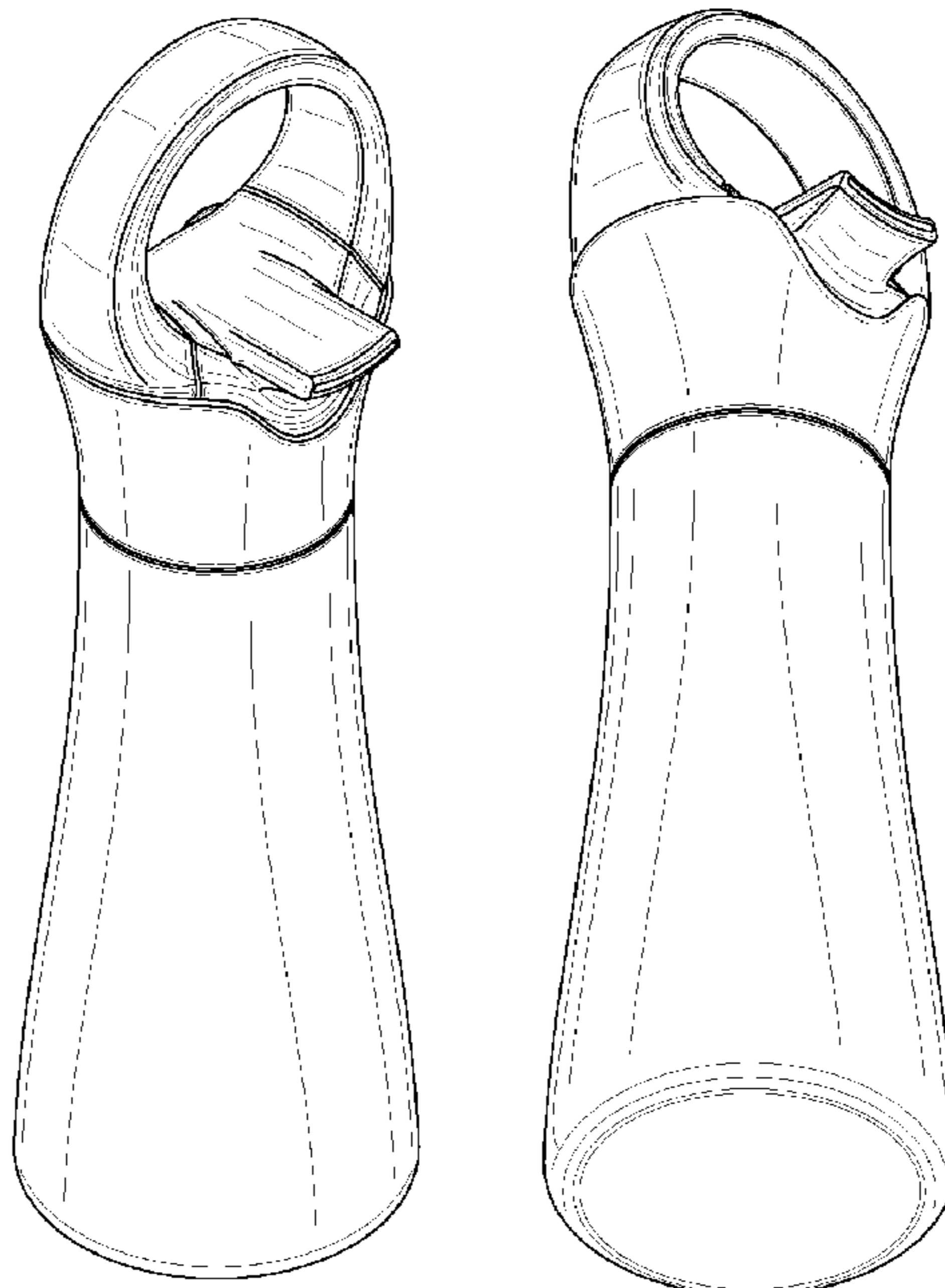

FIG. 1

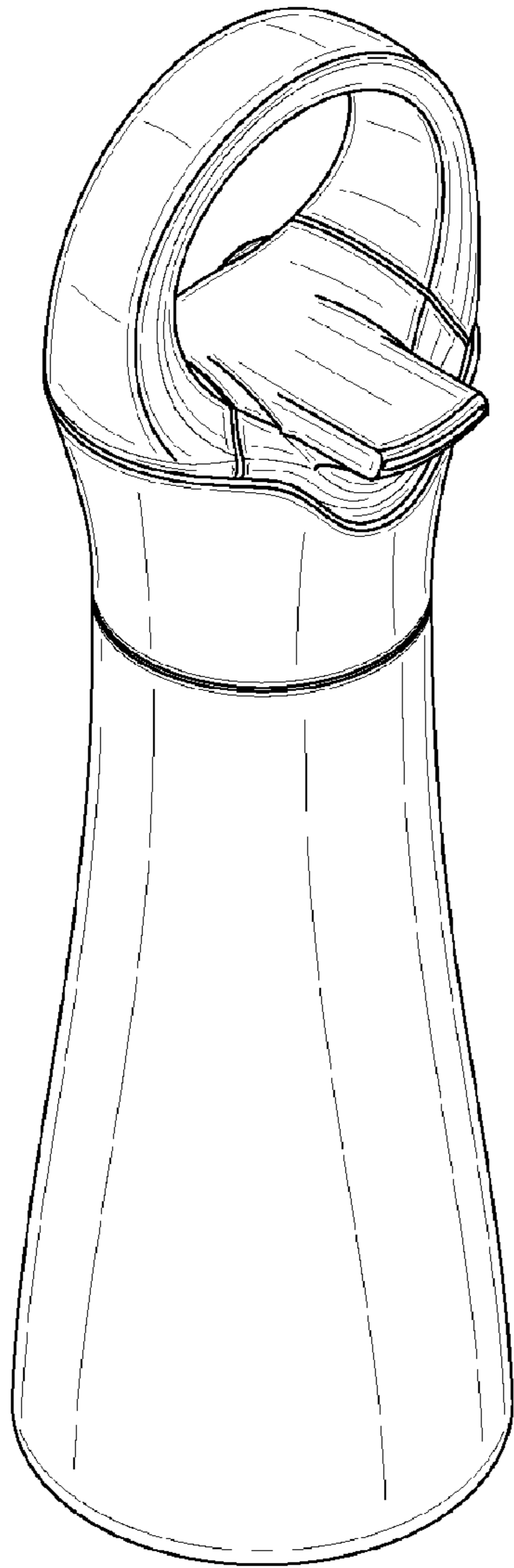

FIG. 2

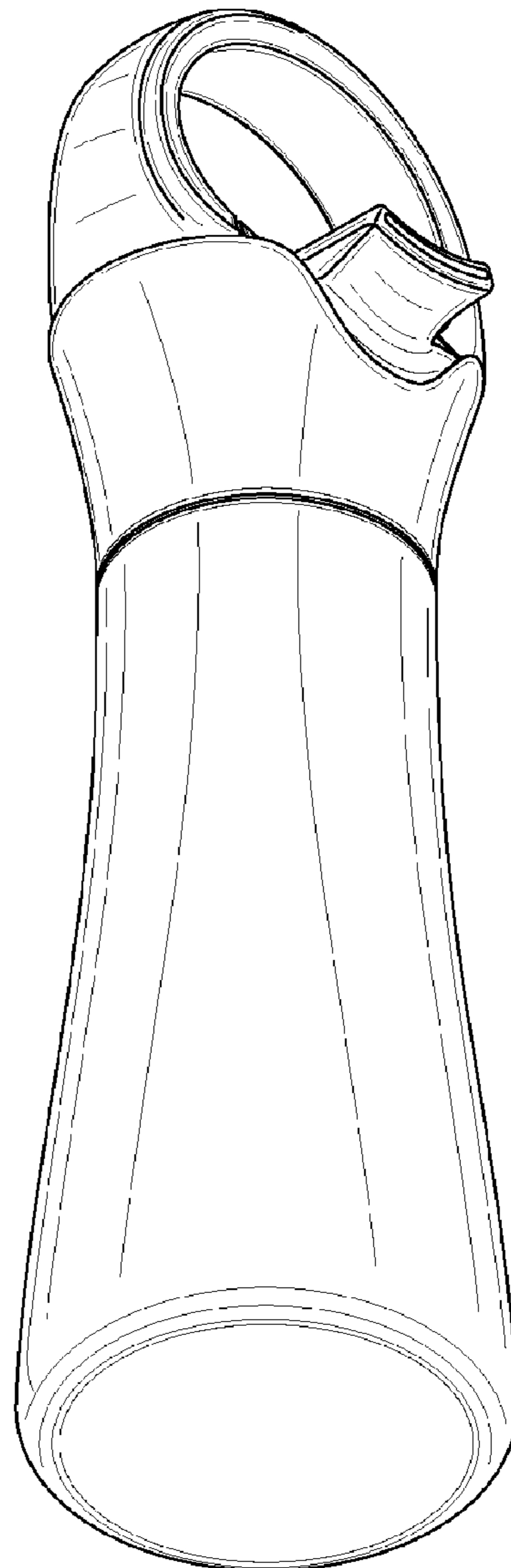

FIG 3

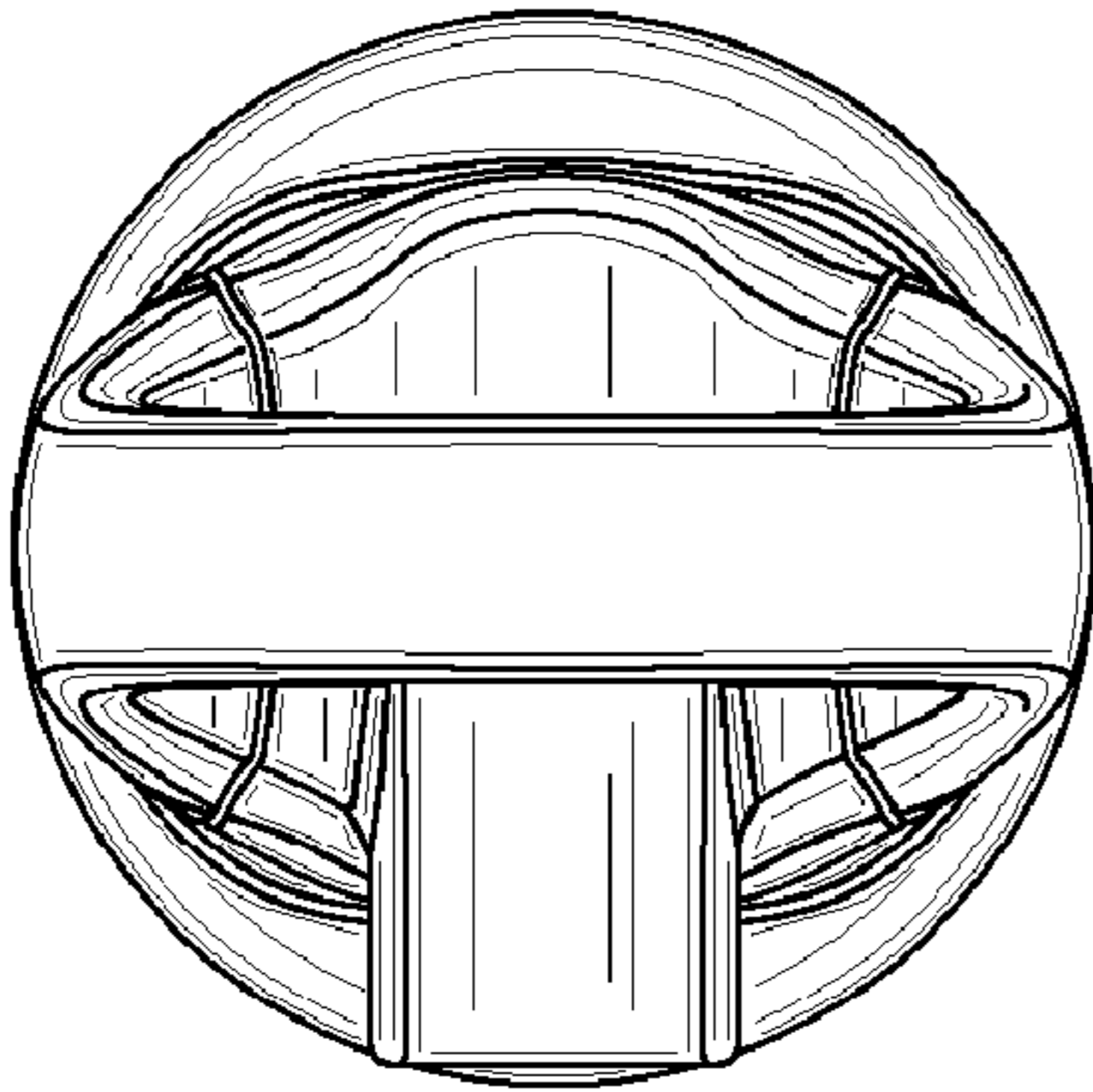
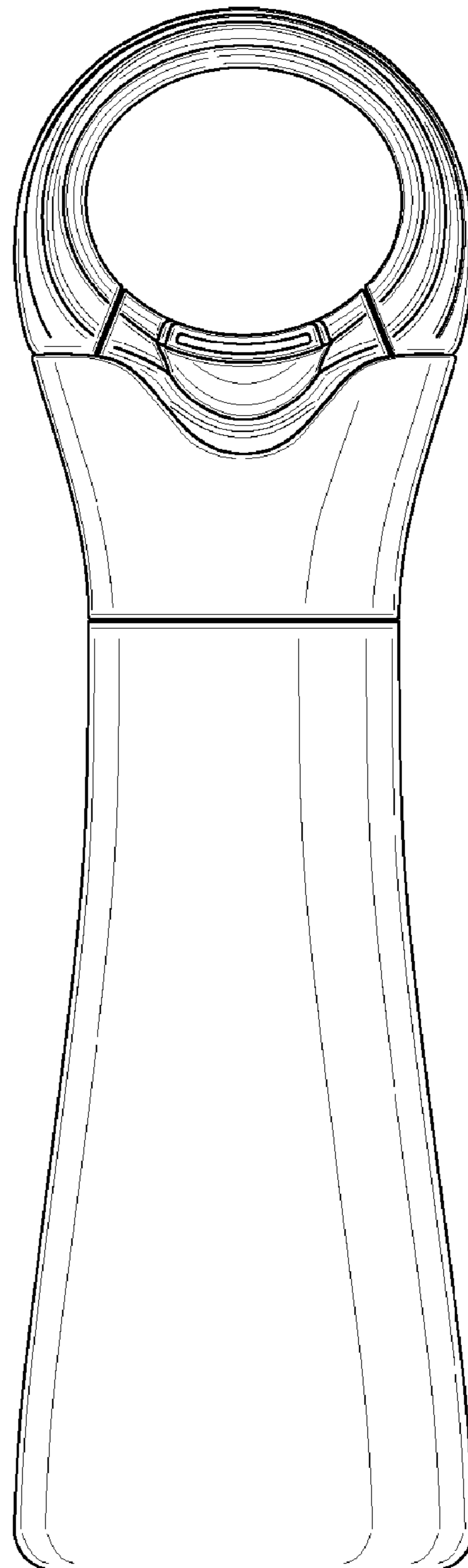
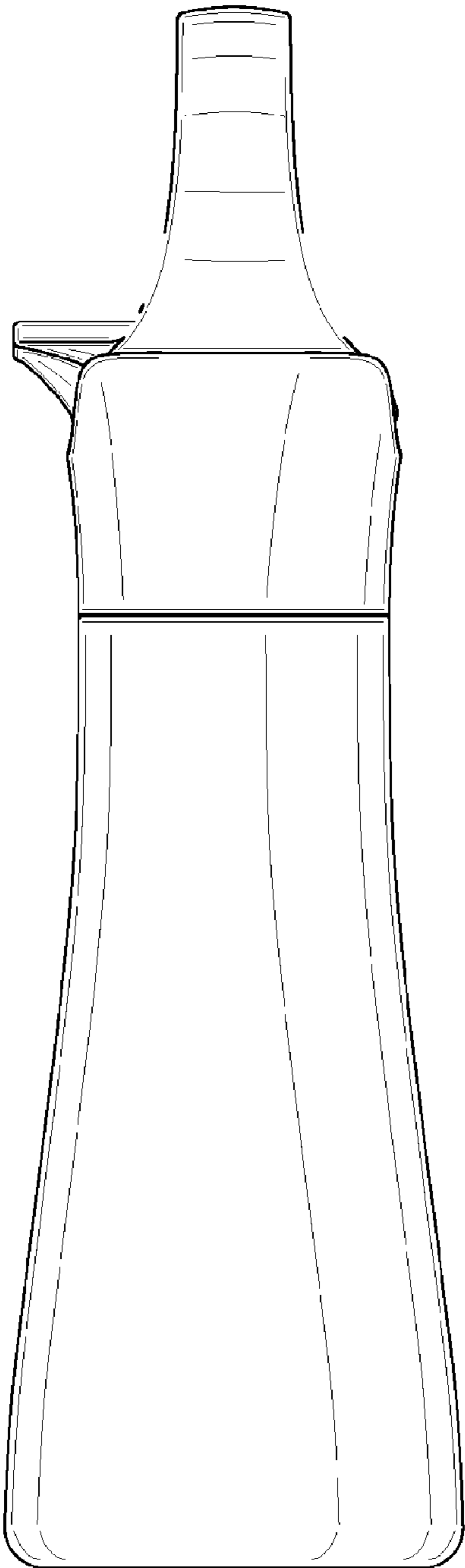

FIG 4



**FIG 5**



**FIG 6**

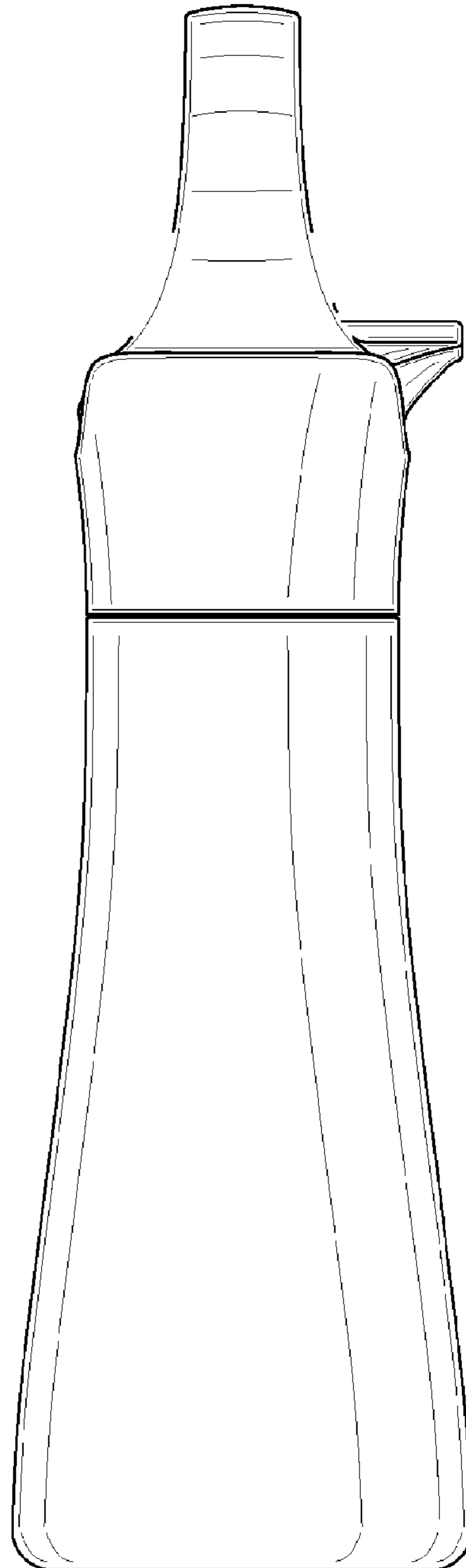

FIG 7

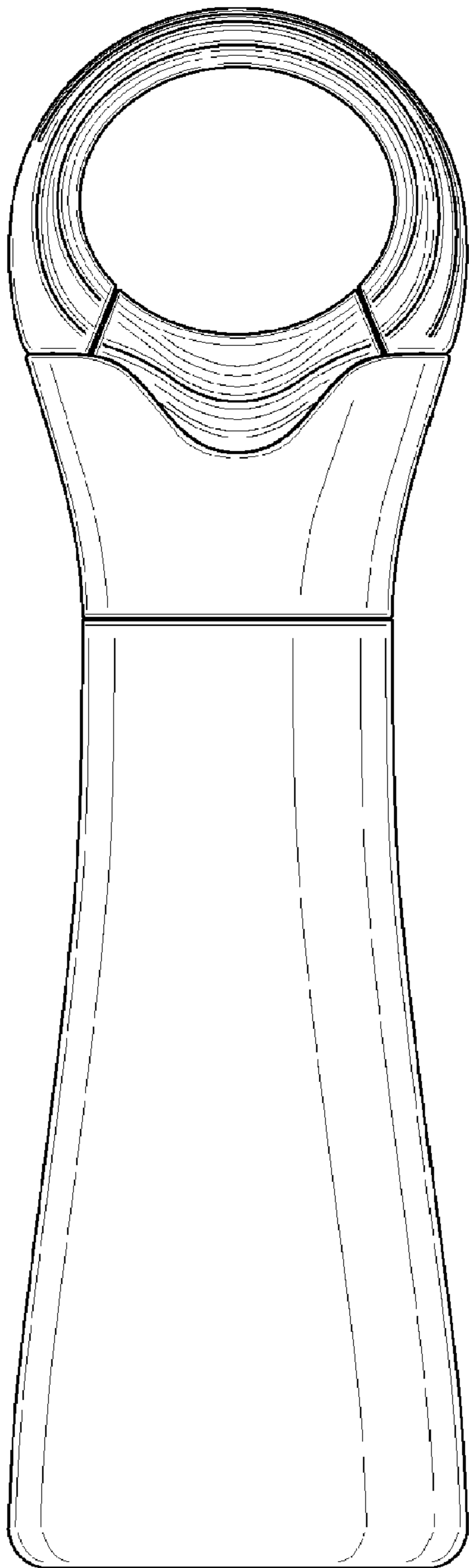

FIG 8

