



US00D656832S

(12) **United States Design Patent**  
**Bowers et al.**

(10) **Patent No.:** **US D656,832 S**

(45) **Date of Patent:** **\*\* Apr. 3, 2012**

(54) **ANGLED-NECK SPRAYER BOTTLE**

(75) Inventors: **Shannon Navarette Bowers**, Phoenix, AZ (US); **Tirso Olivares**, Chicago, IL (US)

(73) Assignee: **The Dial Corporation**, Scottsdale, AZ (US)

(\*\*) Term: **14 Years**

(21) Appl. No.: **29/354,476**

(22) Filed: **Jan. 25, 2010**

(51) **LOC (9) Cl.** ..... **09-01**

(52) **U.S. Cl.** ..... **D9/526; D9/541; D9/543; D9/563; D9/564; D9/575**

(58) **Field of Classification Search** ..... D9/516, D9/523, 525-527, 530, 541-543, 549, 550-551, D9/563-564, 574-575, 682, 685, 693-694; 215/379, 381-382, 384; D23/200, 211, 211.1, D23/211.2, 222, 225-226; 222/215, 381.1

See application file for complete search history.

(56) **References Cited**

**U.S. PATENT DOCUMENTS**

D226,688	S	*	4/1973	Thornton	.....	D9/526 X
D310,960	S	*	10/1990	Verebelyi	.....	D9/526
D323,517	S	*	1/1992	Hoefl	.....	D9/526 X
D350,484	S	*	9/1994	Addis et al.	.....	D9/569 X
D356,036	S	*	3/1995	Hoyt	.....	D9/523
D376,048	S	*	12/1996	Gerhart et al.	.....	D9/526 X
D378,573	S	*	3/1997	Sherman	.....	D9/543 X
D383,678	S	*	9/1997	Syrek	.....	D9/569 X
D385,794	S	*	11/1997	Goettner et al.	.....	D9/523
D392,568	S	*	3/1998	Goettner	.....	D9/526

D402,561	S		12/1998	Utrup et al.	
D406,531	S	*	3/1999	Bodker et al.	..... D9/564 X
5,875,940	A	*	3/1999	Mayfield	..... 222/382
D414,115	S	*	9/1999	Goettner et al.	..... D9/526
D432,021	S	*	10/2000	Caughey et al.	..... D9/543
D434,327	S	*	11/2000	Di Bartolo et al.	..... D9/523
D501,796	S	*	2/2005	Crawford et al.	..... D9/523
D547,659	S	*	7/2007	Heisner	..... D9/516
D553,990	S	*	10/2007	Muhlhausen	..... D9/563 X
D554,511	S	*	11/2007	Muhlhausen	..... D9/564 X
7,306,121	B2	*	12/2007	Ophardt et al.	..... 222/209
D579,779	S	*	11/2008	Rosinski et al.	..... D9/563 X
D585,286	S	*	1/2009	Rosinski et al.	..... D9/550 X
D648,631	S	*	11/2011	Smith	..... D9/543 X
2003/0080209	A1		5/2003	Dubreuil et al.	

\* cited by examiner

*Primary Examiner* — Carol P Rademaker

(74) *Attorney, Agent, or Firm* — Paul A. Pappalardo

(57) **CLAIM**

The ornamental design for an angled-neck sprayer bottle, as shown and described.

**DESCRIPTION**

FIG. 1 is a top, rear, and right side perspective view of an angled-neck sprayer bottle embodying our new design; FIG. 2 is a front elevational view thereof; FIG. 3 is a rear elevational view thereof; FIG. 4 is a right side elevational view thereof; FIG. 5 is a left side elevational view thereof; and, FIG. 6 is a top plan view thereof.

The broken lines shown in the drawing views are included for the purpose of showing environmental structure that forms no part of the claimed design.

**1 Claim, 5 Drawing Sheets**

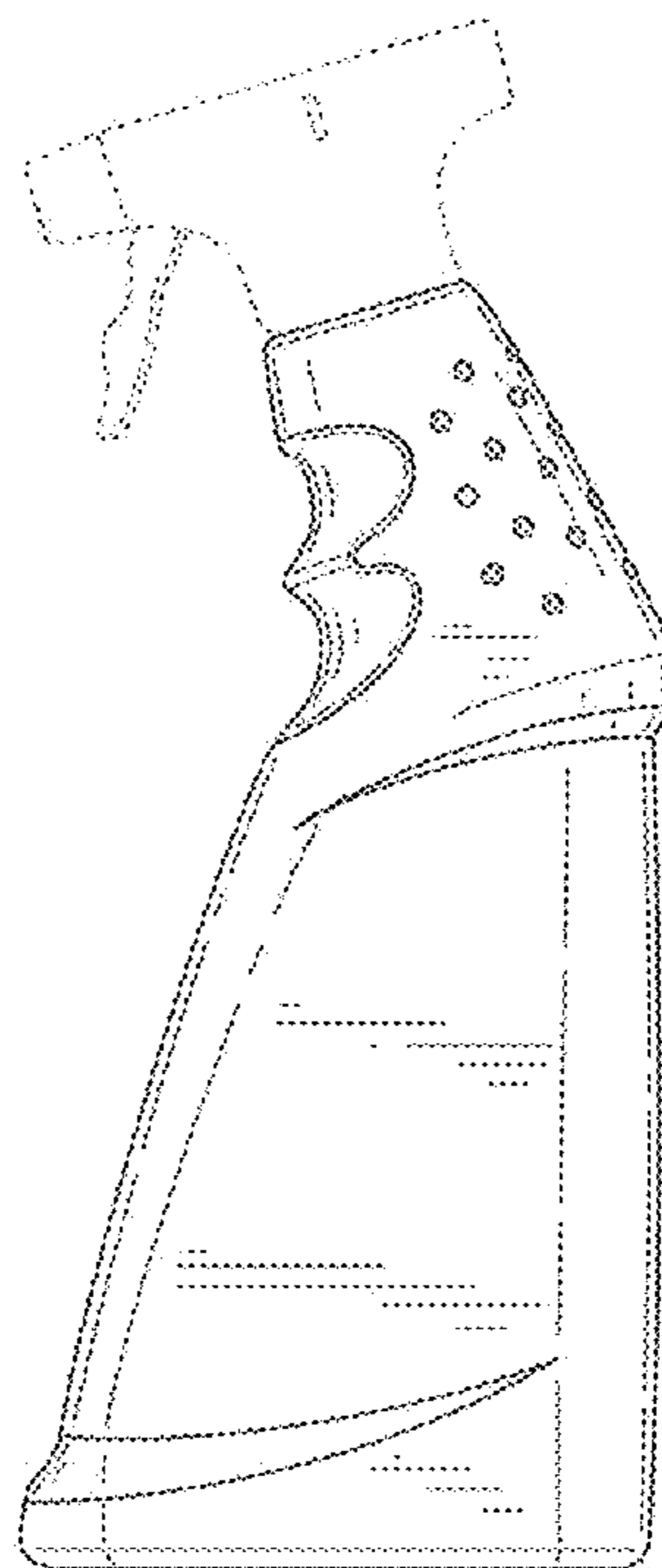
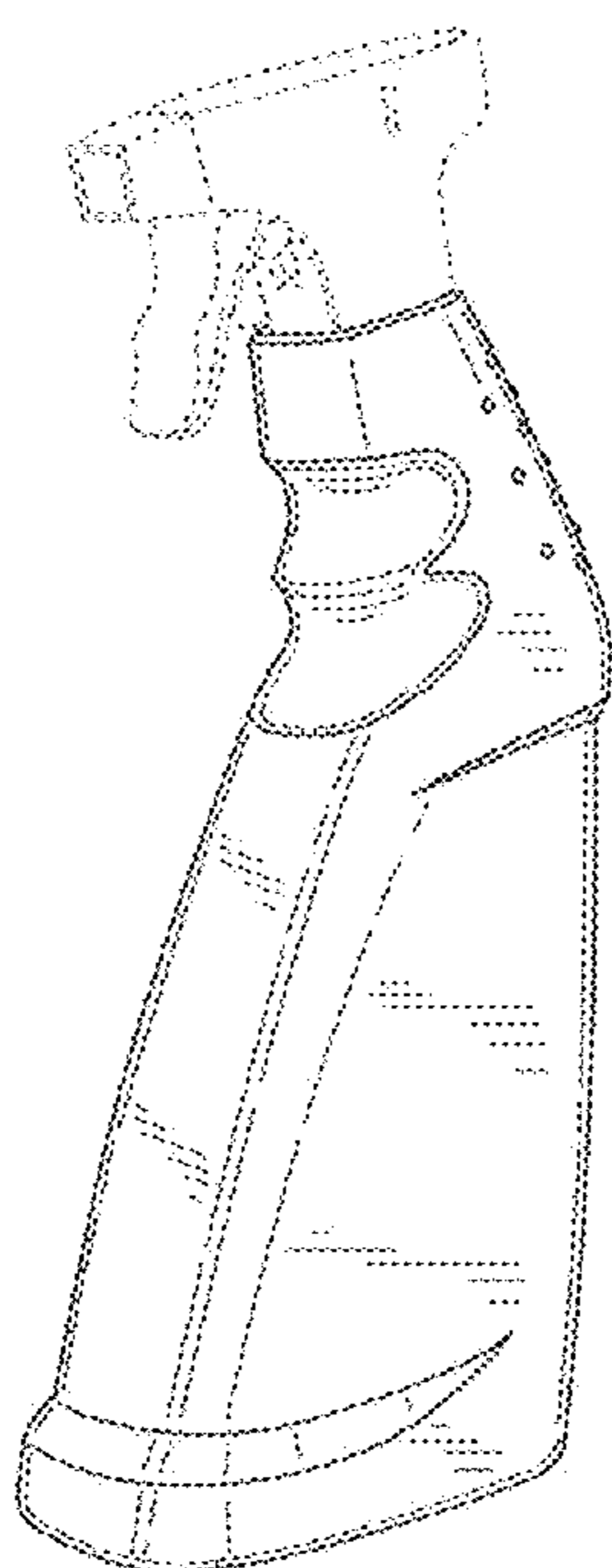

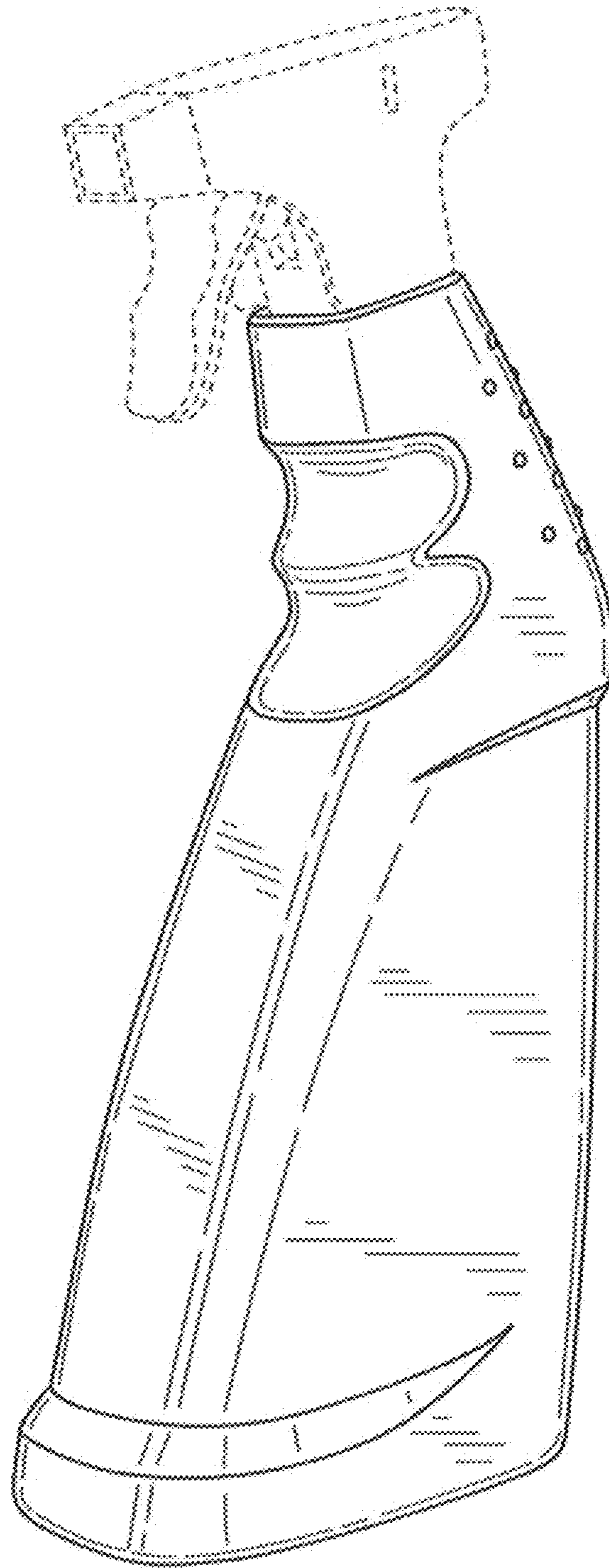

FIG. 1

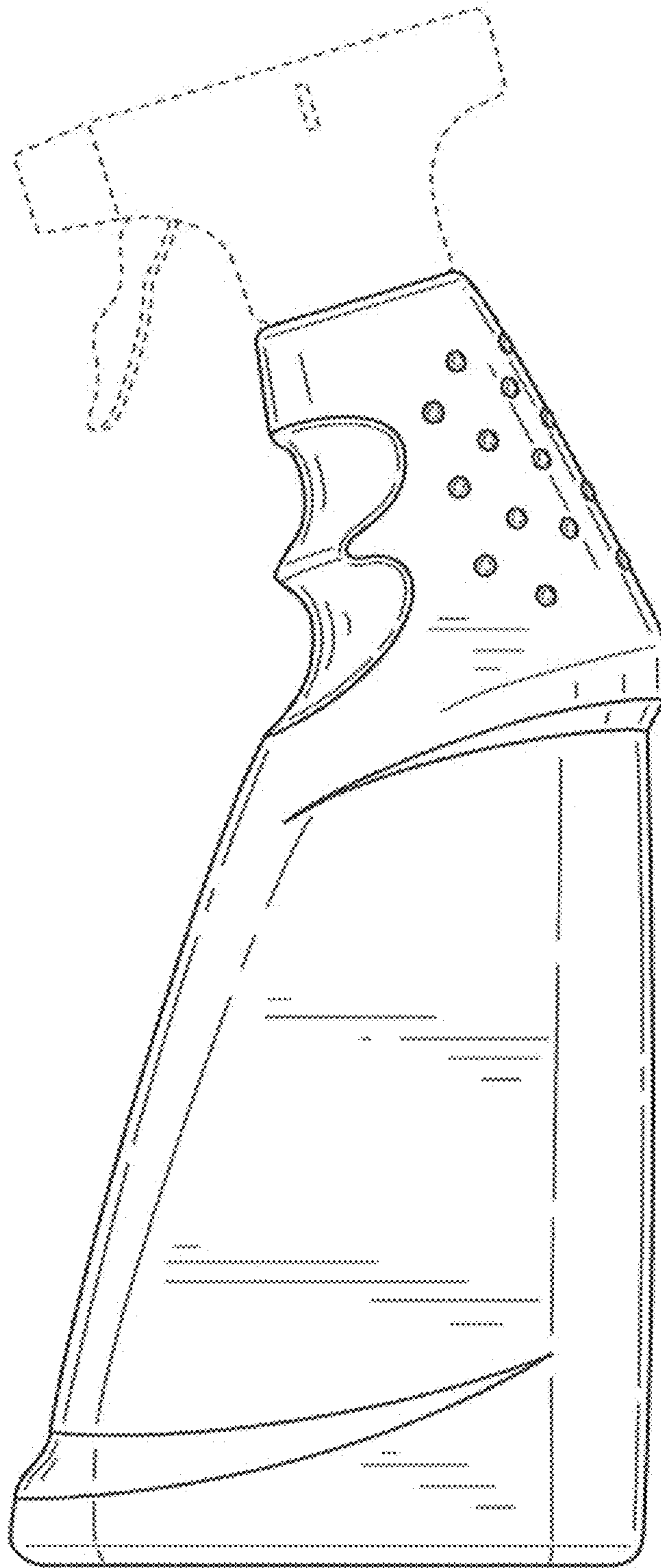

FIG. 2

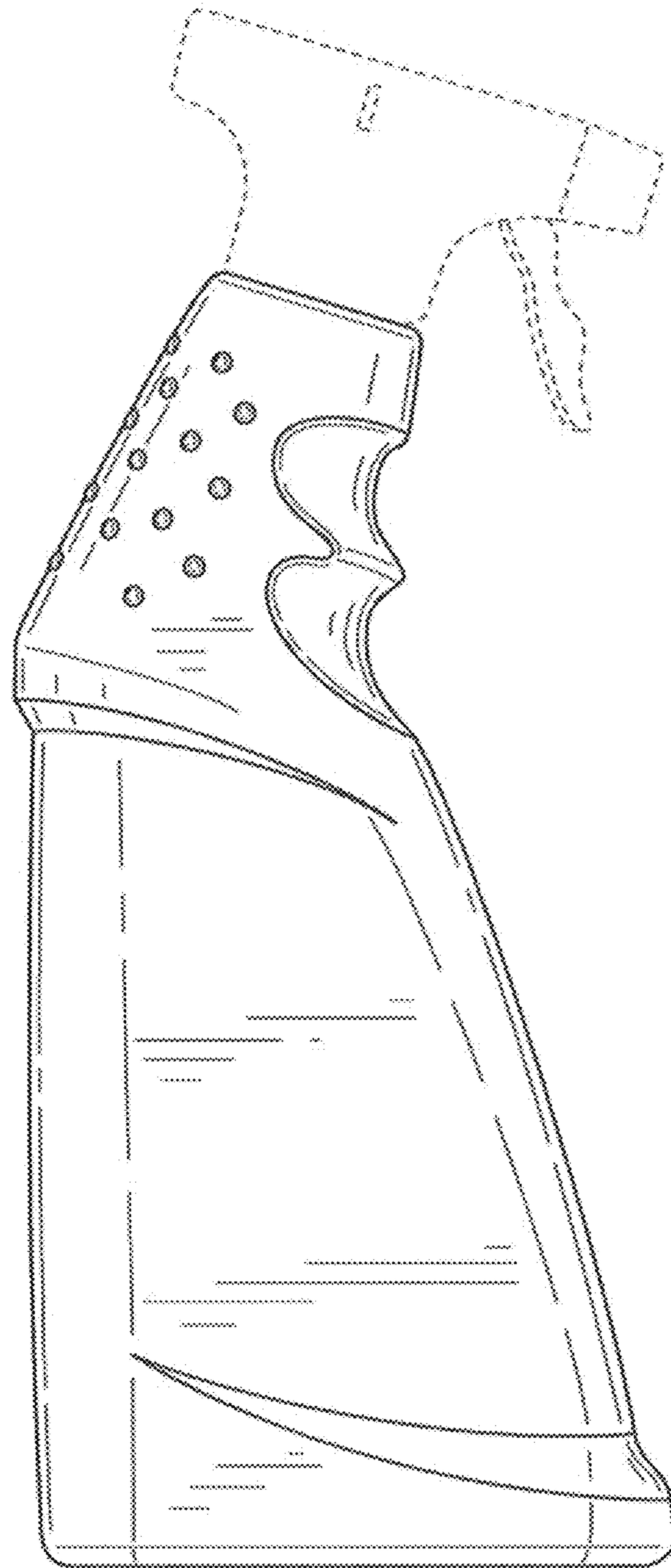

FIG. 3

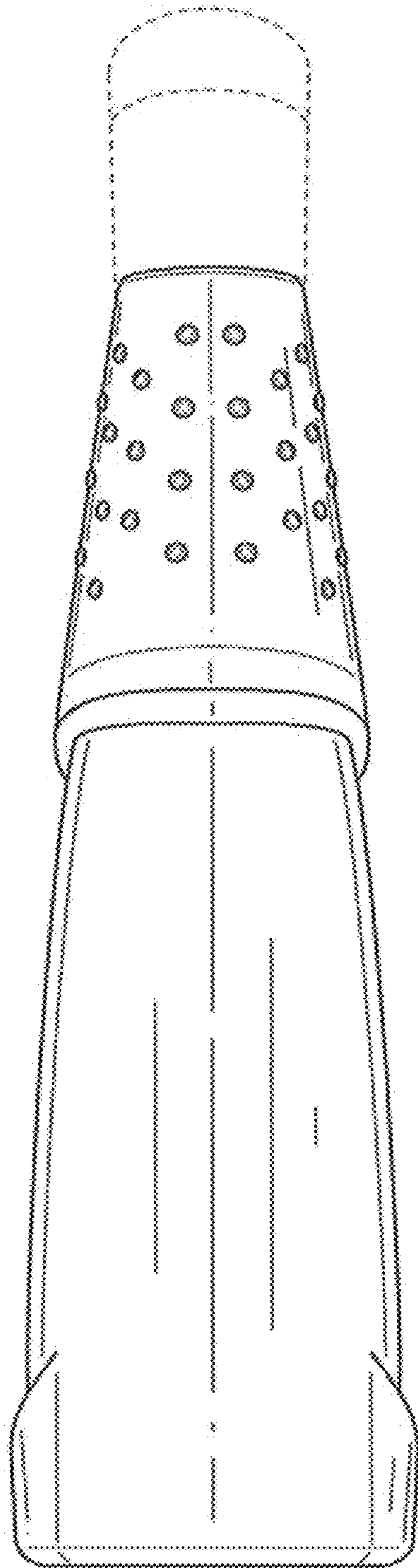

FIG. 4

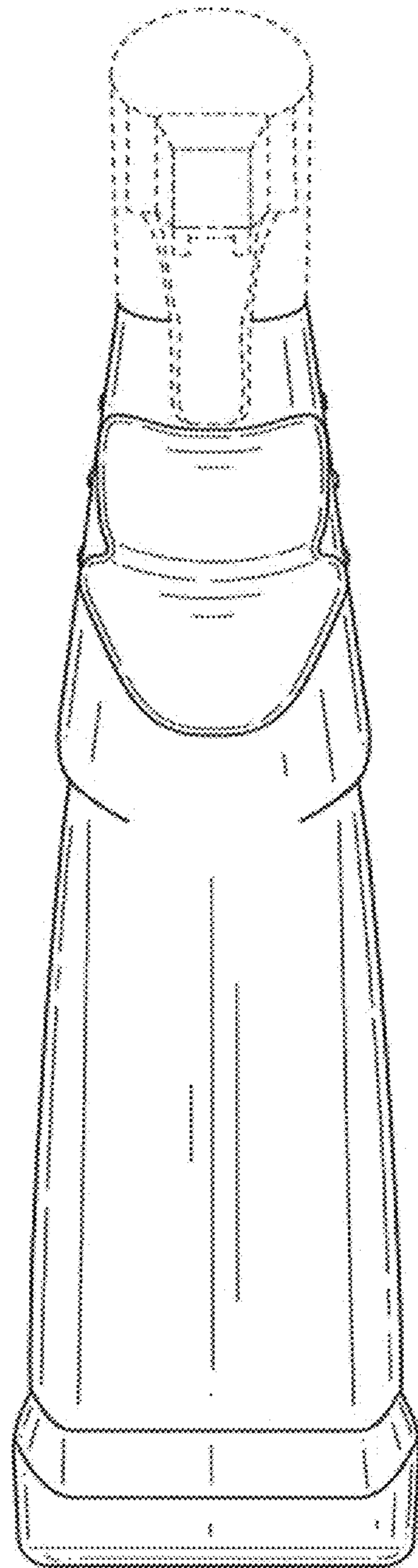

FIG. 5

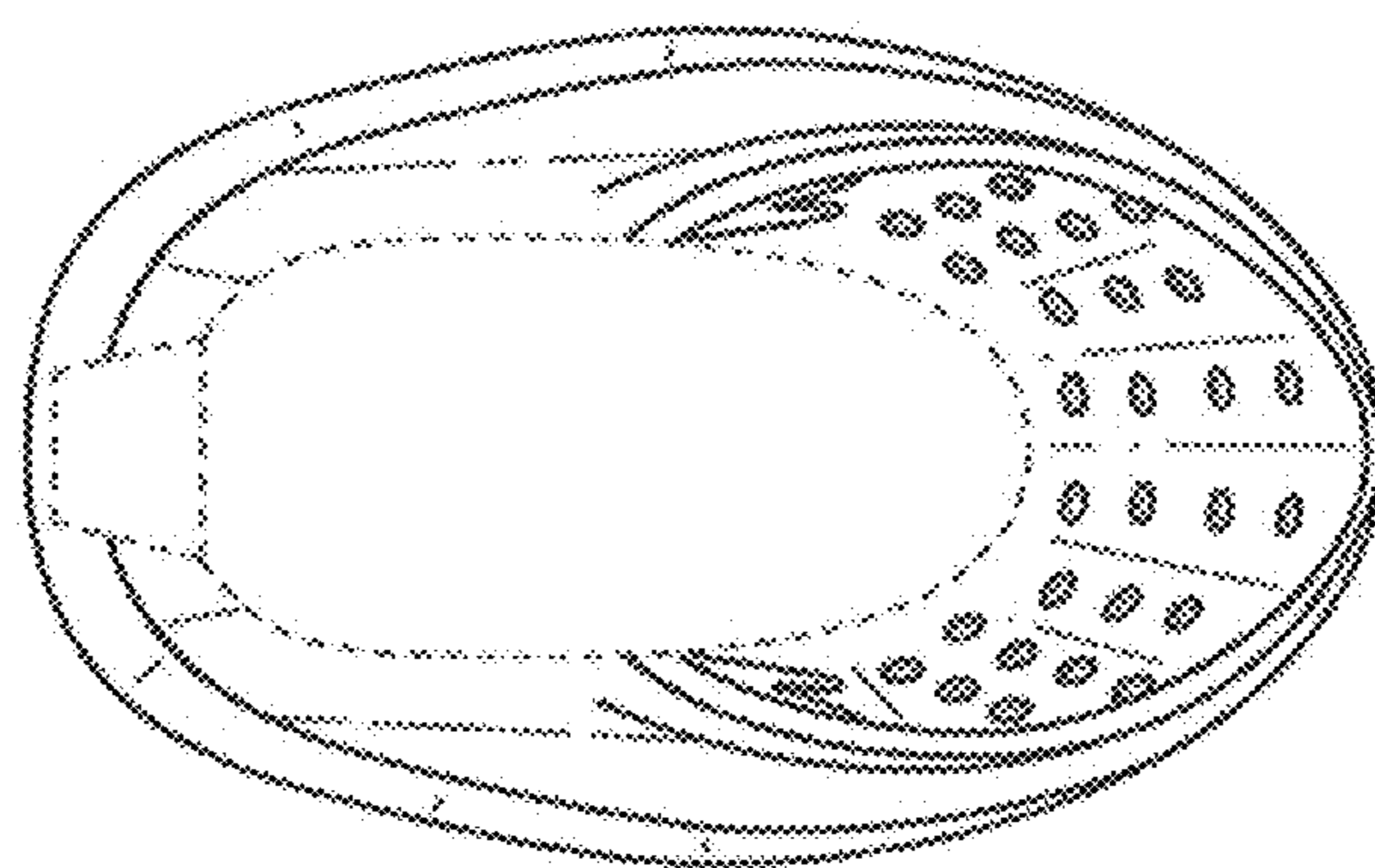

FIG. 6