



US00D656752S

(12) **United States Design Patent**  
**Moll**

(10) **Patent No.:** **US D656,752 S**  
(45) **Date of Patent:** **\*\* Apr. 3, 2012**

(54) **CHAIR**

(75) Inventor: **Reiner Moll**, Schwaebisch Gmuend (DE)

(73) Assignee: **Interstuhl Bueromoebel GmbH & Co. KG**, Messstetten (DE)

(\*\*) Term: **14 Years**

(21) Appl. No.: **29/368,532**

(22) Filed: **Aug. 25, 2010**

(30) **Foreign Application Priority Data**

Jul. 9, 2010 (EP) ..... 001224034-001

(51) **LOC (9) Cl.** ..... **06-01**

(52) **U.S. Cl.** ..... **D6/366**

(58) **Field of Classification Search** ..... D6/334-336,  
D6/360, 364, 365, 366, 367, 374, 379, 380,  
D6/498, 500-502; 297/411.2, 411.27, 411.36,  
297/452.21, 452.26, 452.29, 452.32, 452.33,  
297/452.35, 452.37, 452.48

See application file for complete search history.

(56) **References Cited**

**U.S. PATENT DOCUMENTS**

D327,781 S \* 7/1992 Citterio ..... D6/366  
D327,782 S \* 7/1992 Citterio ..... D6/366

D390,712 S \* 2/1998 Koepke et al. .... D6/366  
D410,799 S \* 6/1999 Meda ..... D6/366  
D541,061 S \* 4/2007 Benden et al. .... D6/366  
D557,026 S \* 12/2007 Klaasen et al. .... D6/366  
D579,682 S \* 11/2008 Neil ..... D6/366  
D597,331 S \* 8/2009 Neil ..... D6/366

\* cited by examiner

*Primary Examiner* — Mimosa De

(74) *Attorney, Agent, or Firm* — Michael J. Striker

(57) **CLAIM**

The ornamental design for a chair, as shown and described

**DESCRIPTION**

FIG. 1 is a perspective view of a chair showing my new design;

FIG. 2 is a front view thereof;

FIG. 3 is a rear perspective view thereof;

FIG. 4 is a side view thereof;

FIG. 5 is the opposite side view of FIG. 4 thereof;

FIG. 6 is a rear view thereof;

FIG. 7 is a top view thereof; and,

FIG. 8 is a bottom view thereof.

The broken lines showing on the FIG. 8 bottom view are for illustrative purposes only and form no part of the claimed design.

**1 Claim, 8 Drawing Sheets**

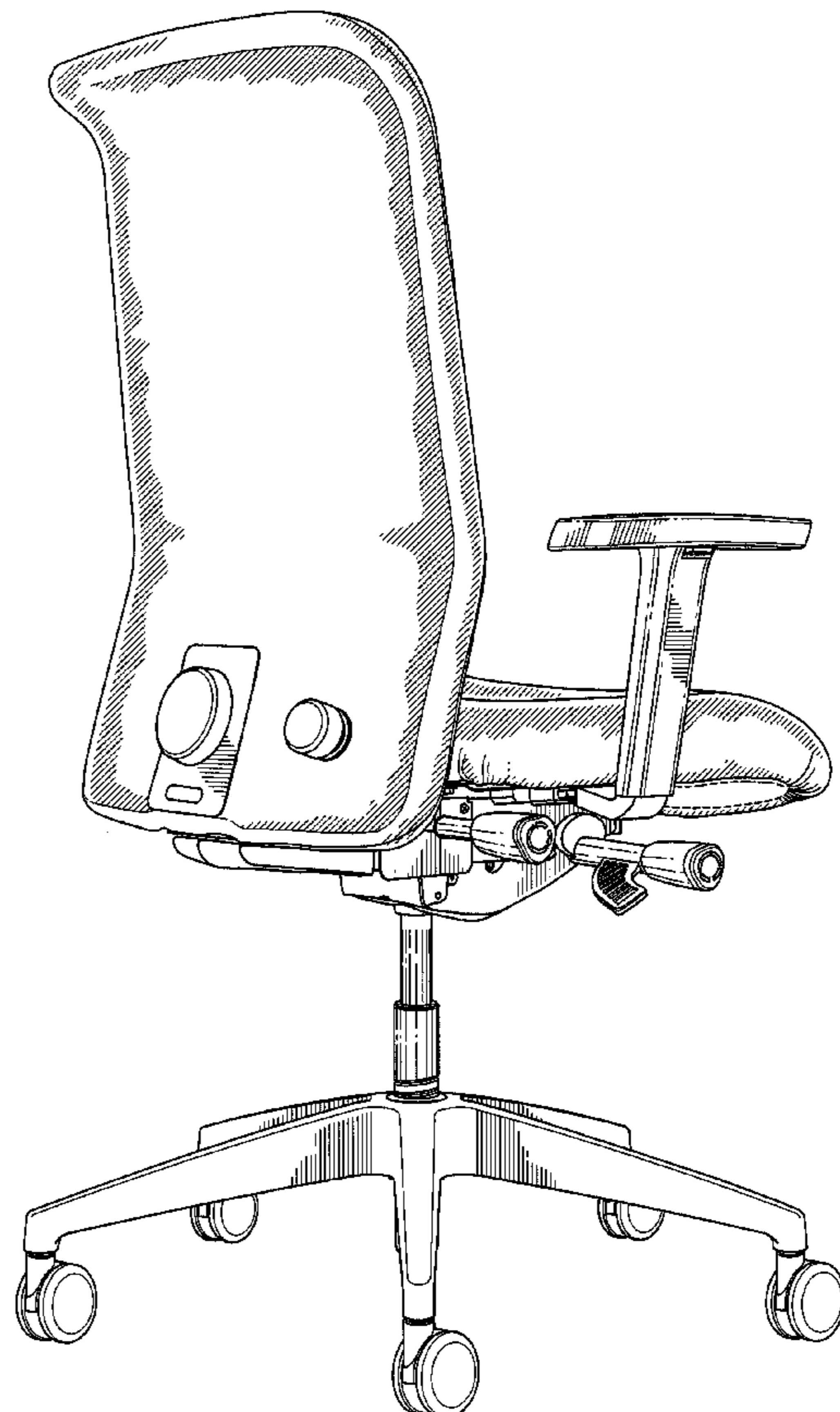
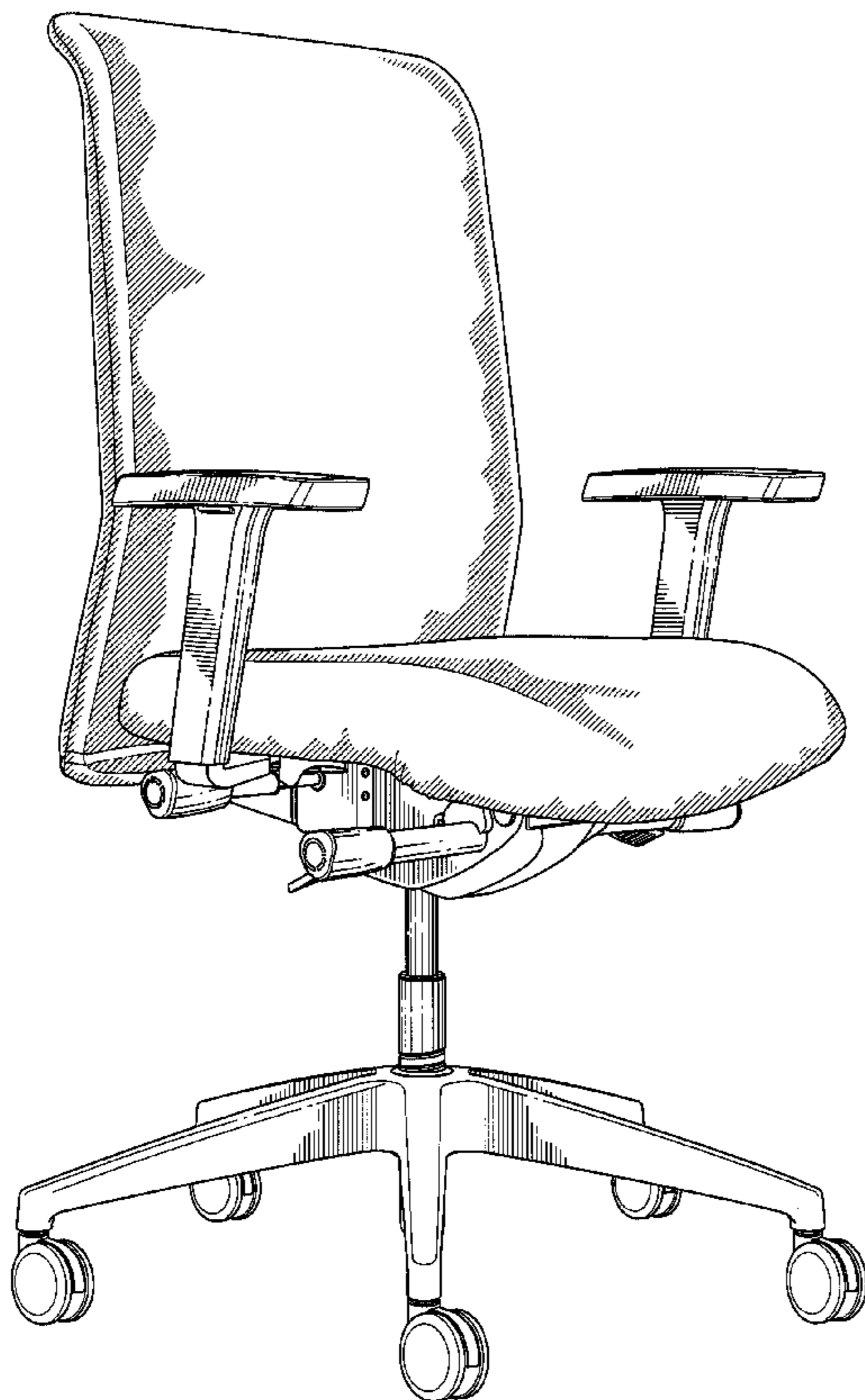

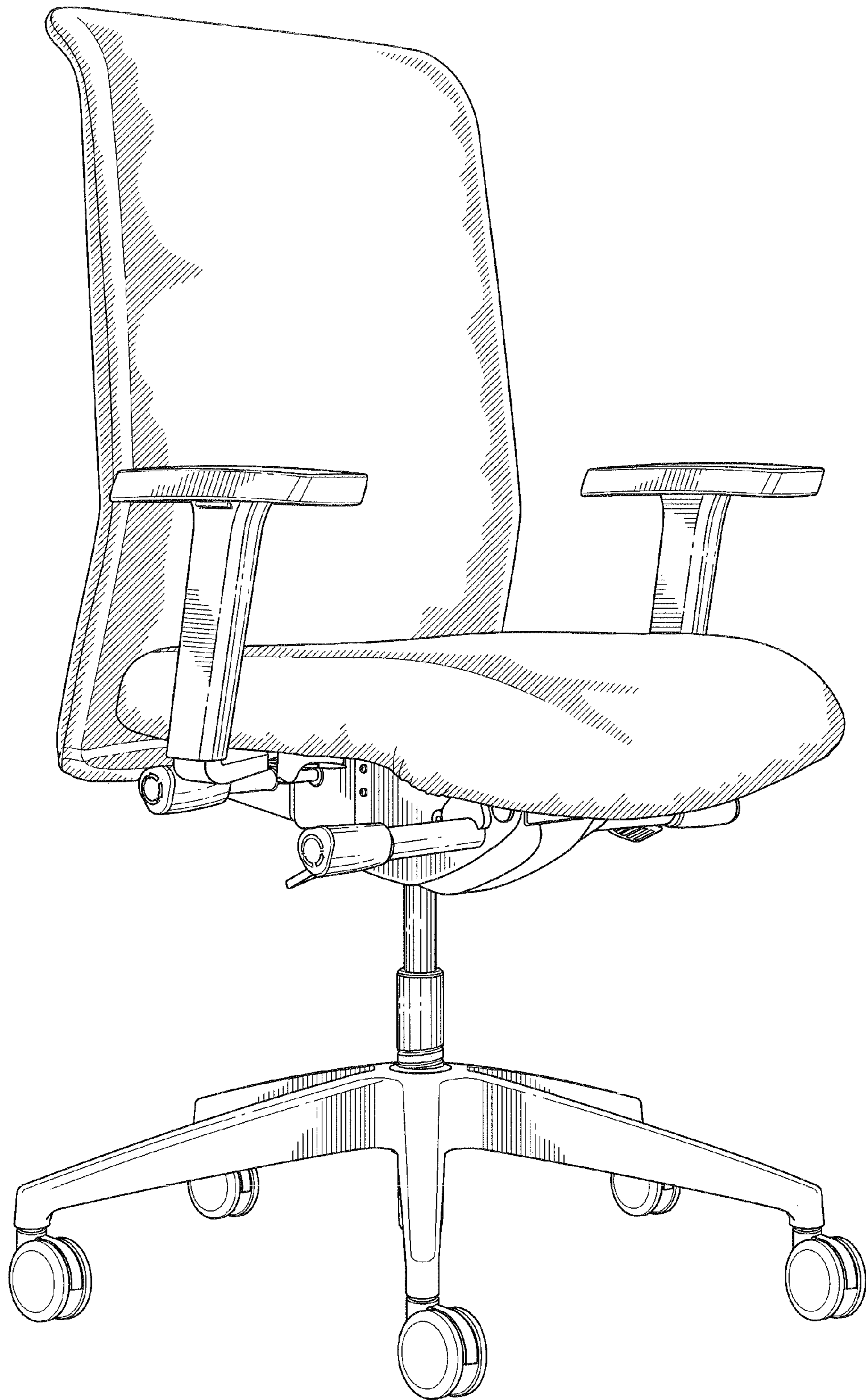

FIG. 1

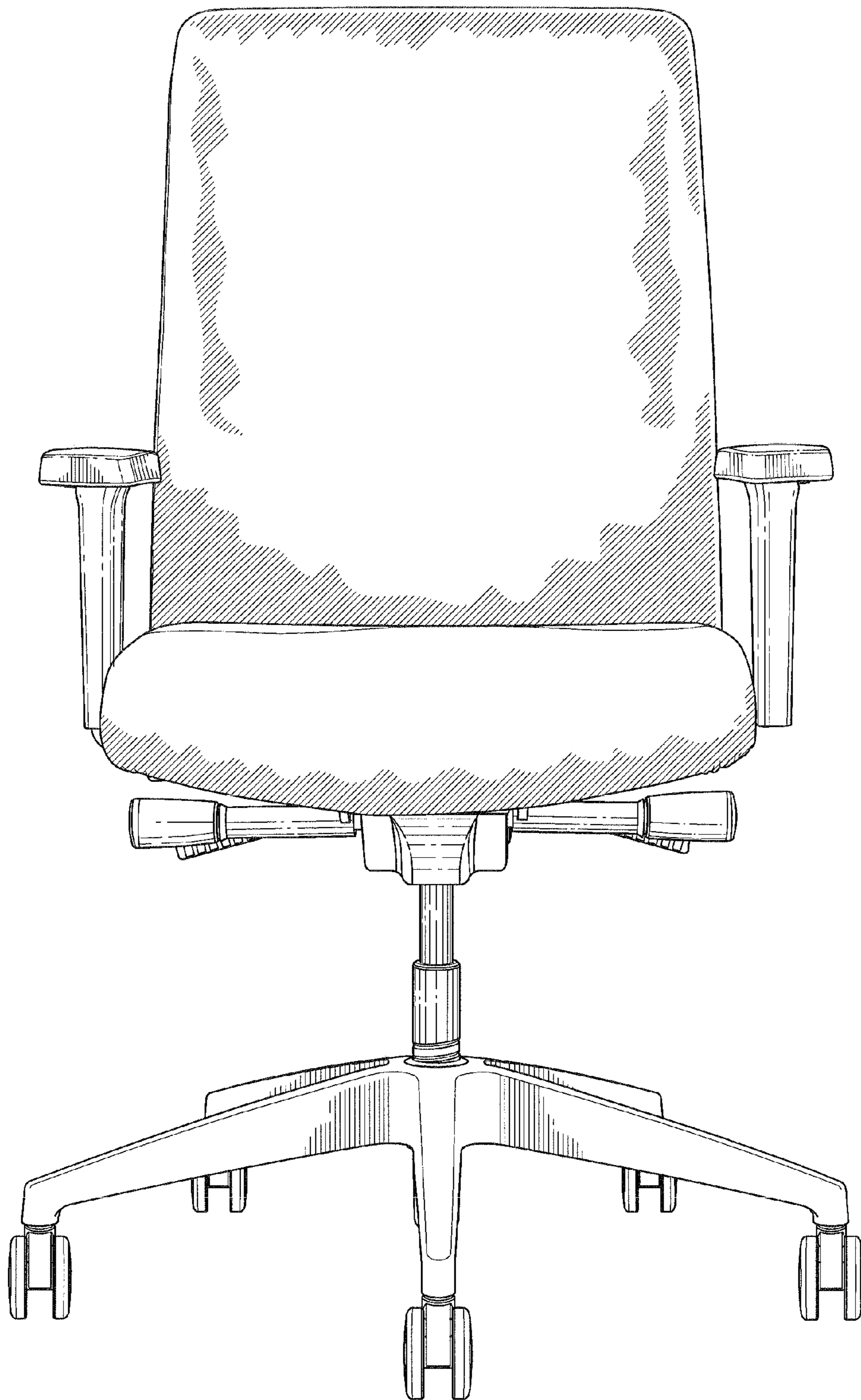

FIG. 2

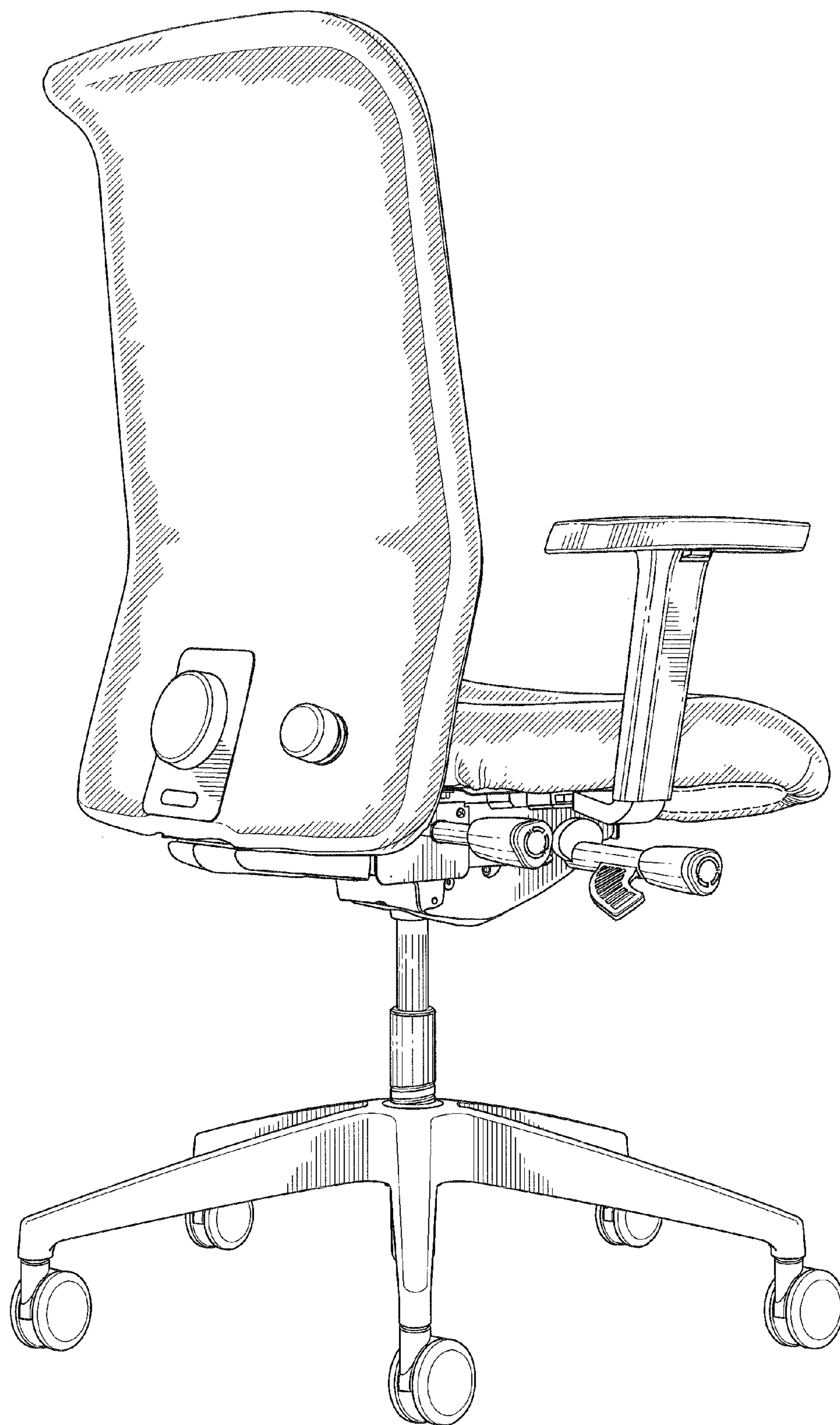

FIG. 3

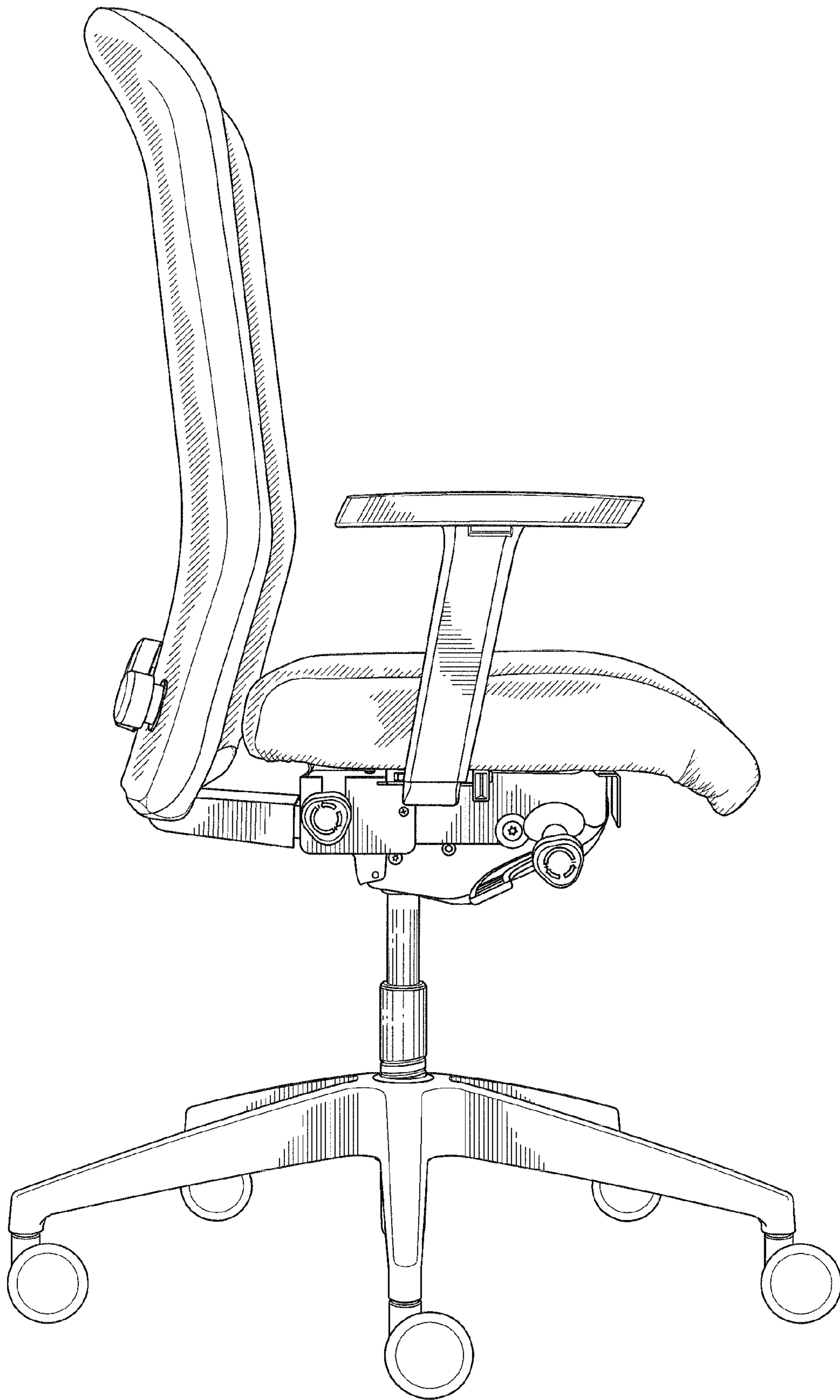

FIG. 4

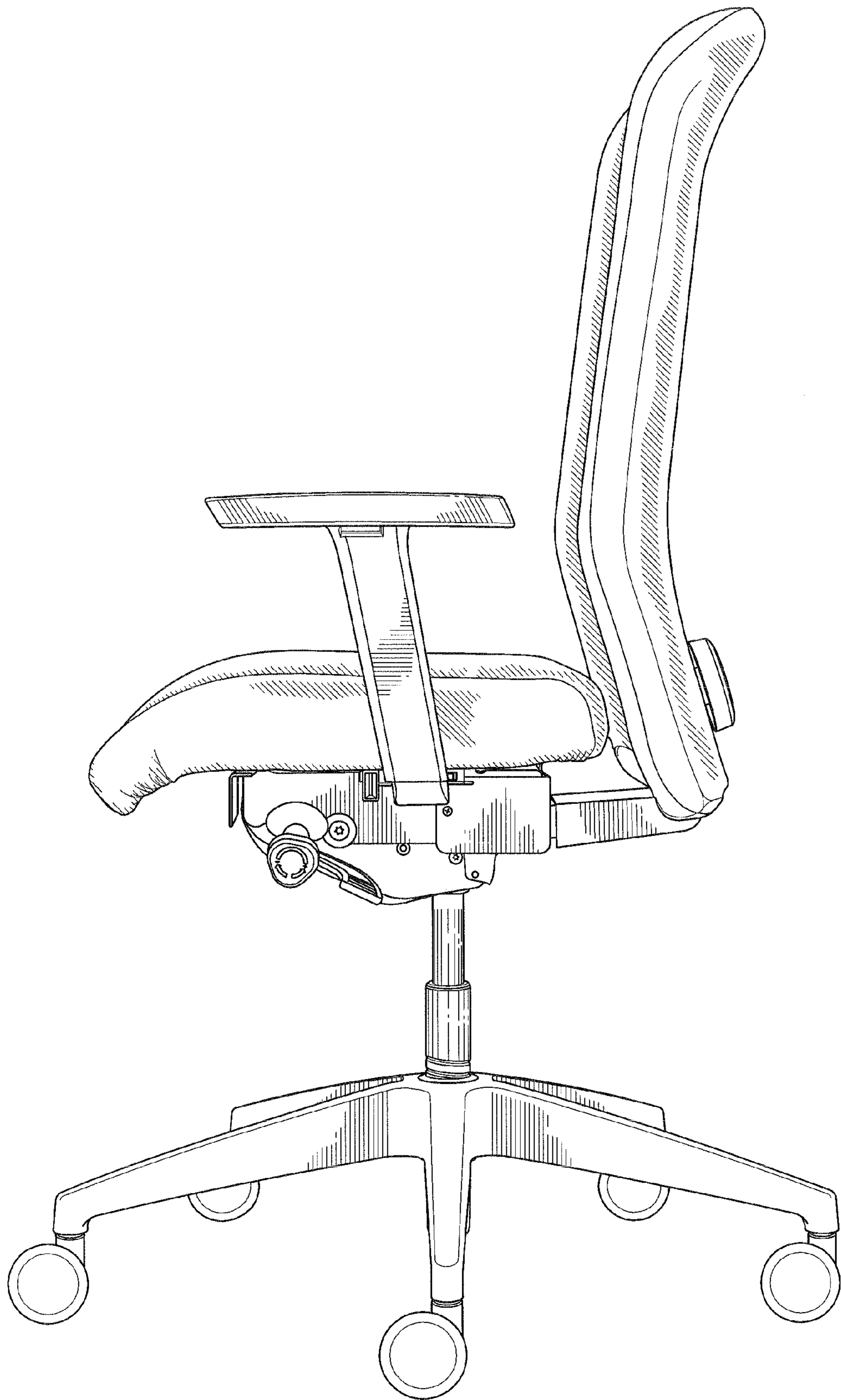

FIG. 5

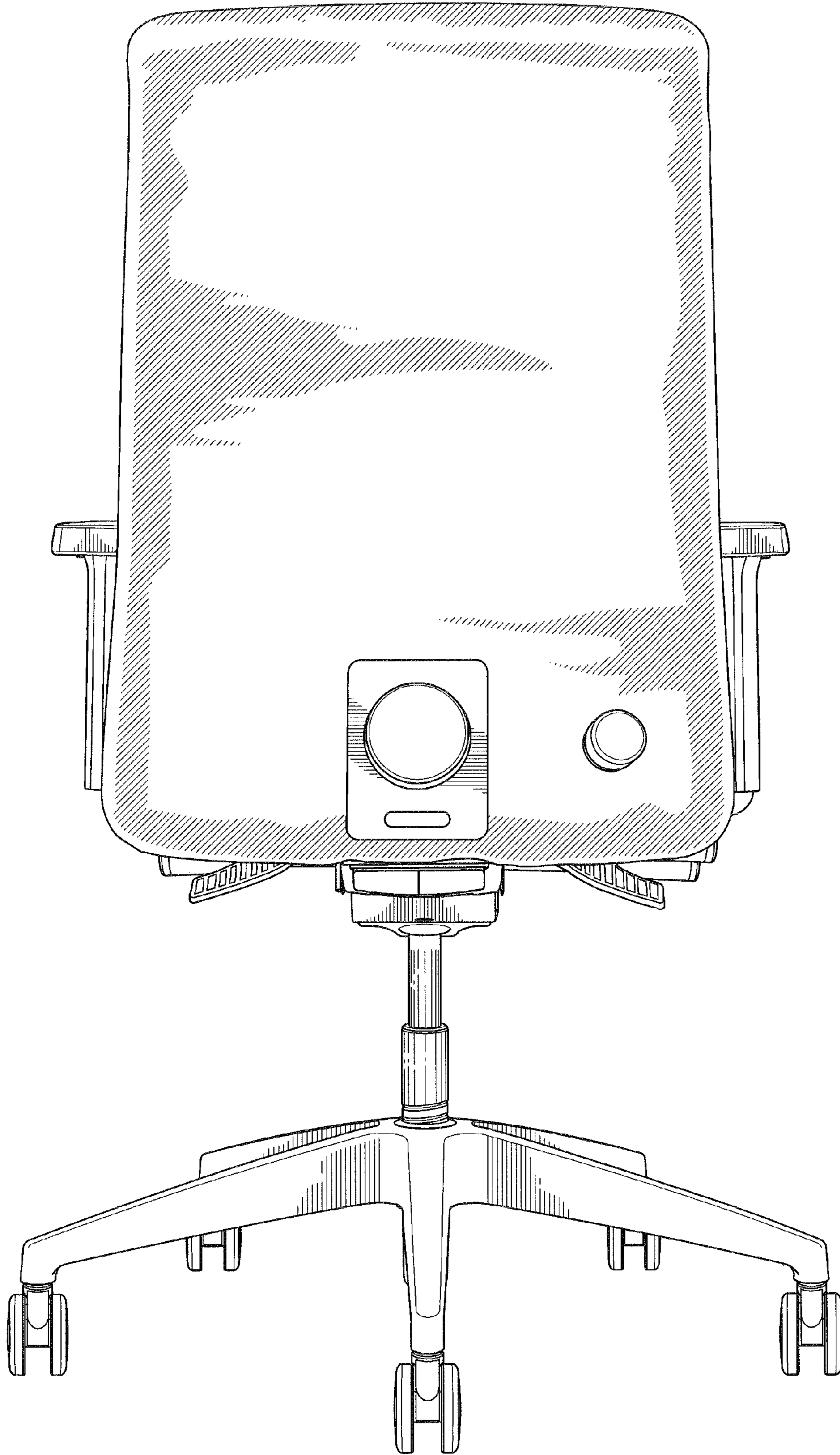

FIG. 6

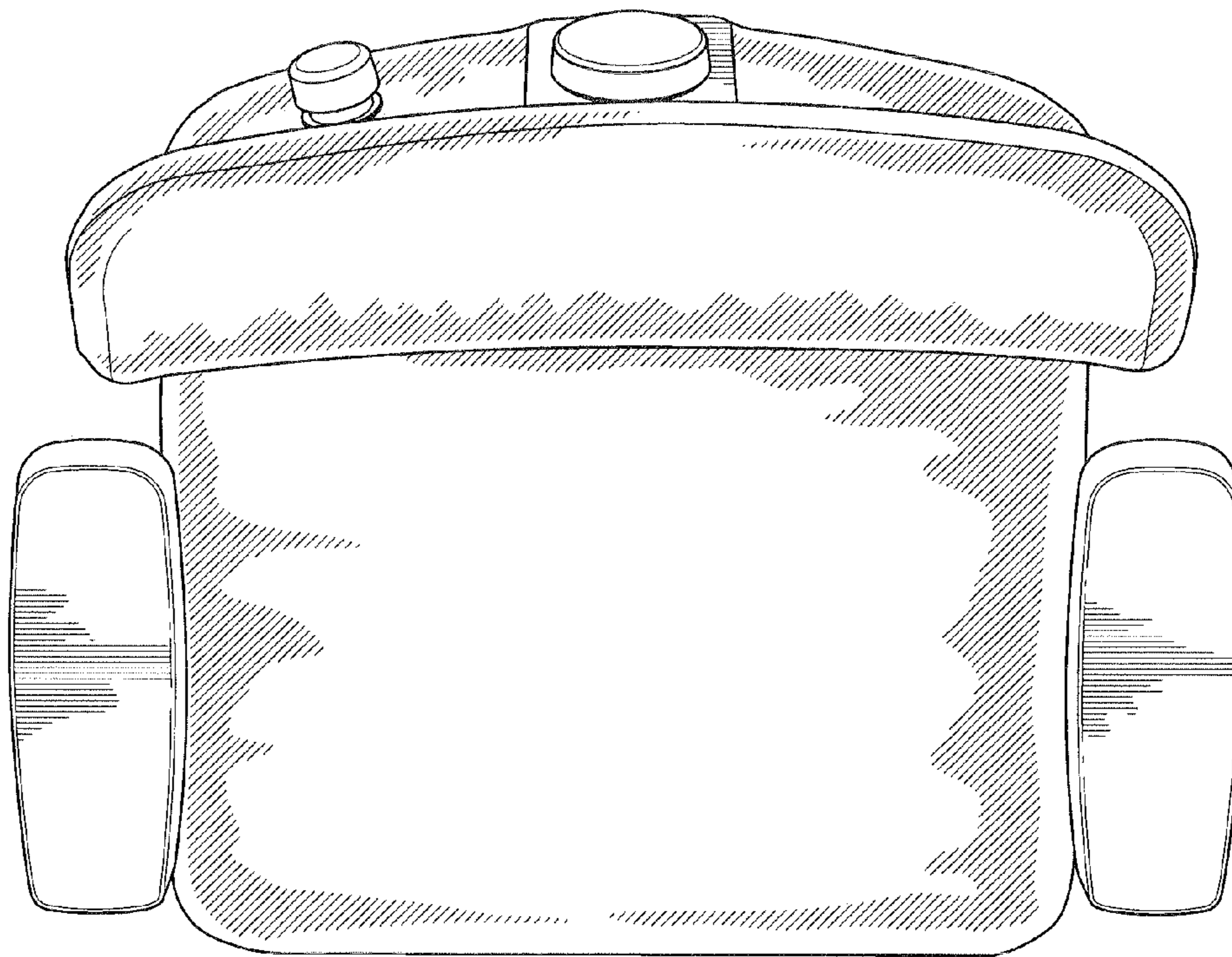

FIG. 7



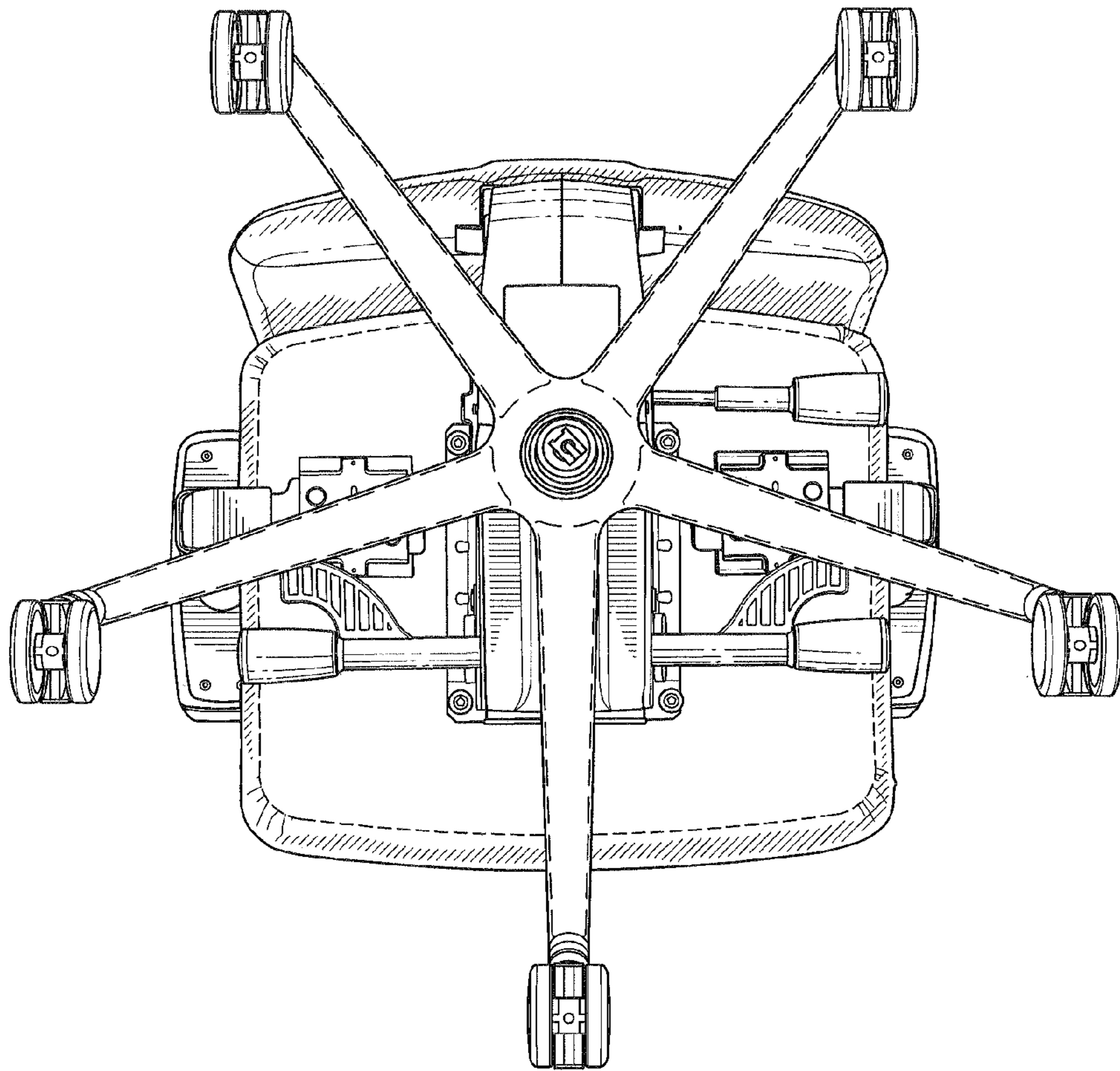

FIG. 8