



US00D656554S

(12) **United States Design Patent**
Mar

(10) **Patent No.:** **US D656,554 S**
(45) **Date of Patent:** **** Mar. 27, 2012**

(54) **PORTABLE VIDEO GAME CONSOLE**

(75) Inventor: **Steven Mar**, South El Monte, CA (US)

(73) Assignee: **Hyperkin Inc.**, South El Monte, CA (US)

(**) Term: **14 Years**

(21) Appl. No.: **29/396,737**

(22) Filed: **Jul. 6, 2011**

(51) **LOC (9) Cl.** **21-91**

(52) **U.S. Cl.** **D21/329; D21/324**

(58) **Field of Classification Search** D21/324-333;
D14/496, 203.1-203.7; 273/148 B; 463/1,
463/29-35, 46, 47; 345/156-161

See application file for complete search history.

(56) **References Cited**

U.S. PATENT DOCUMENTS

5,161,803	A *	11/1992	Ohara	463/44
5,643,087	A *	7/1997	Marcus et al.	463/38
5,645,277	A *	7/1997	Cheng	273/148 B
5,785,317	A *	7/1998	Sasaki	273/148 B
6,042,478	A *	3/2000	Ng	463/44
D425,942	S *	5/2000	Tomizawa	D21/329
D428,448	S *	7/2000	Kitamori	D21/329

D428,938	S *	8/2000	Tomizawa	D21/329
D449,347	S *	10/2001	Christianson	D21/329
D453,536	S *	2/2002	Ota et al.	D21/329
D529,493	S *	10/2006	Ogasawara	D14/356
D539,354	S *	3/2007	Mak	D21/329
D613,341	S	4/2010	Mar et al.		
D646,726	S *	10/2011	Avery	D21/329

* cited by examiner

Primary Examiner — Prabhakar Deshmukh

(74) *Attorney, Agent, or Firm* — Edward C. Schewe

(57) **CLAIM**

The ornamental design for a portable video game console, as shown and described.

DESCRIPTION

FIG. 1 is a top perspective view of a portable video game console showing my new design.

FIG. 2 is a bottom perspective view thereof;

FIG. 3 is a bottom plan view thereof;

FIG. 4 is a front elevational view thereof;

FIG. 5 is a rear elevational view thereof;

FIG. 6 is a top plan view thereof;

FIG. 7 is a left side elevational view thereof; and,

FIG. 8 is right side elevational view thereof.

1 Claim, 5 Drawing Sheets

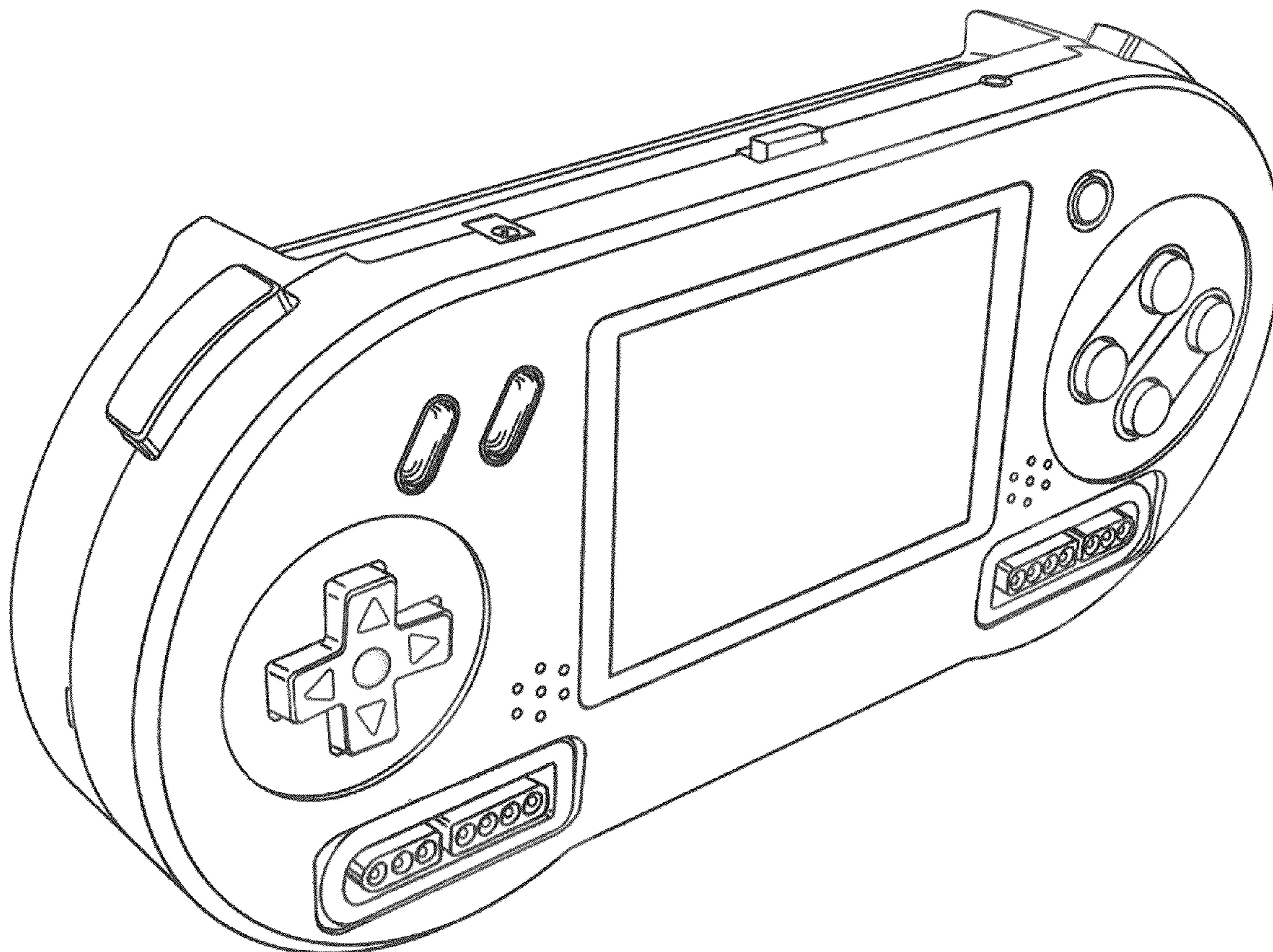

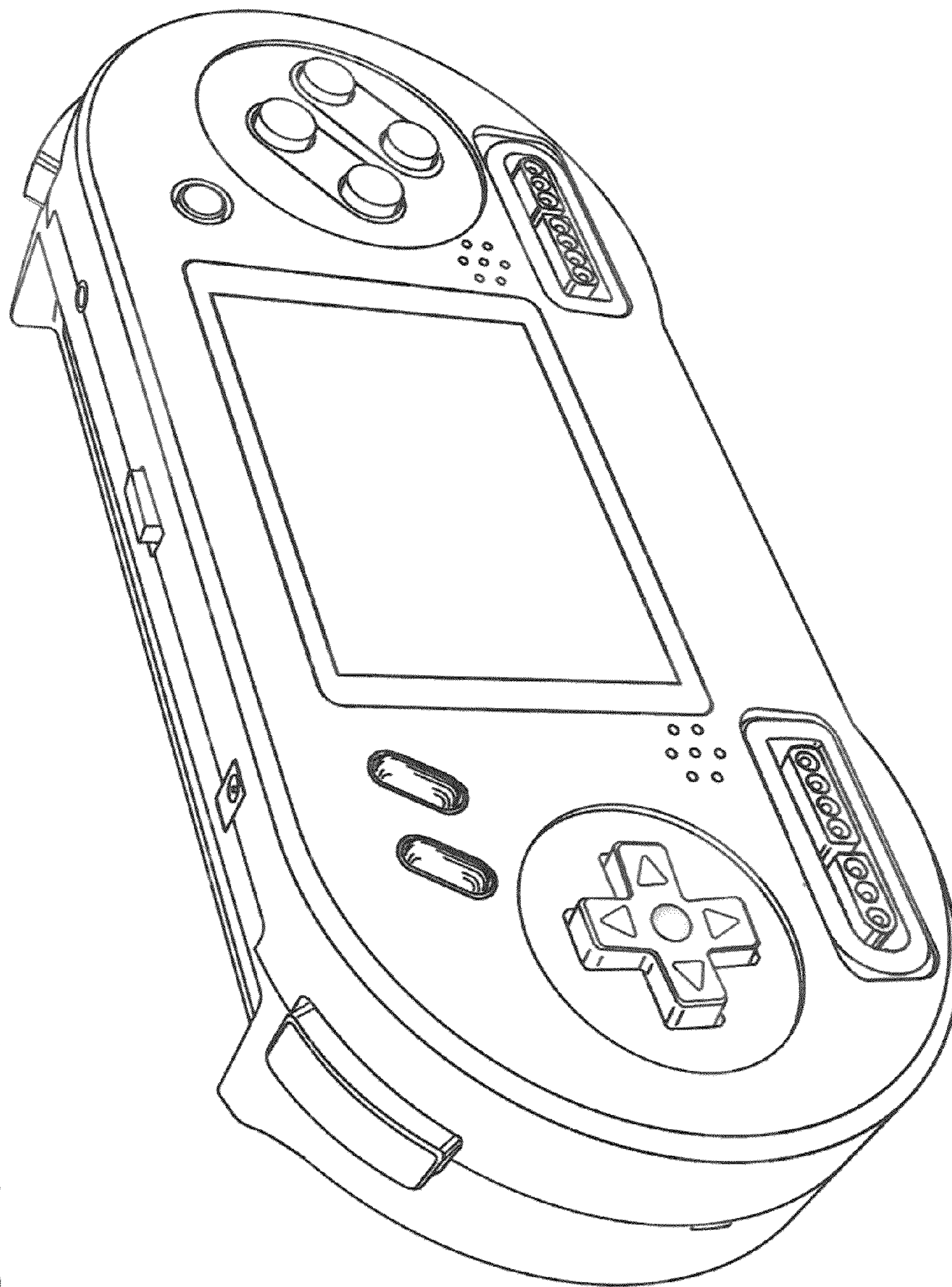

FIG. 1

FIG. 2

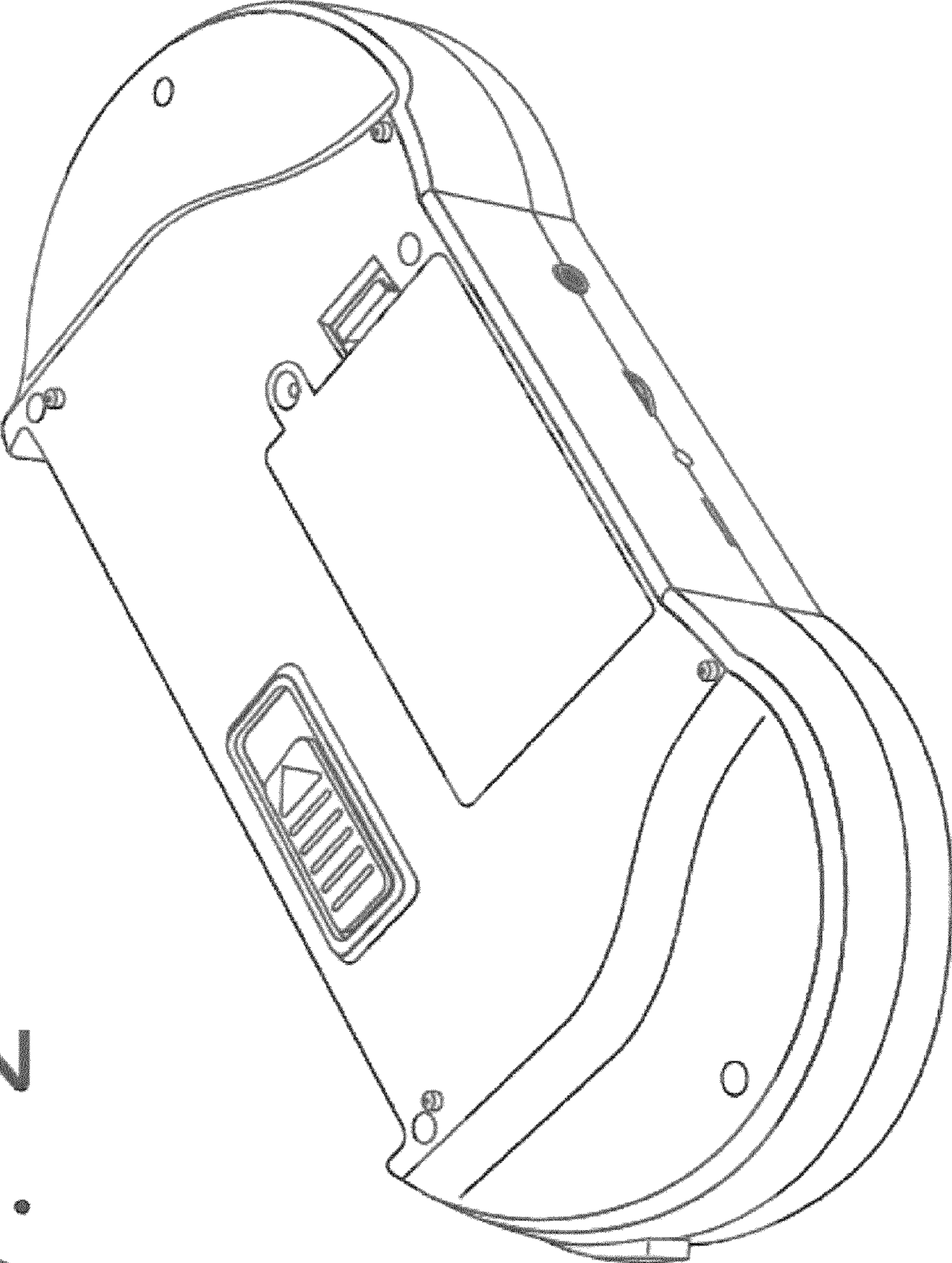

FIG. 3

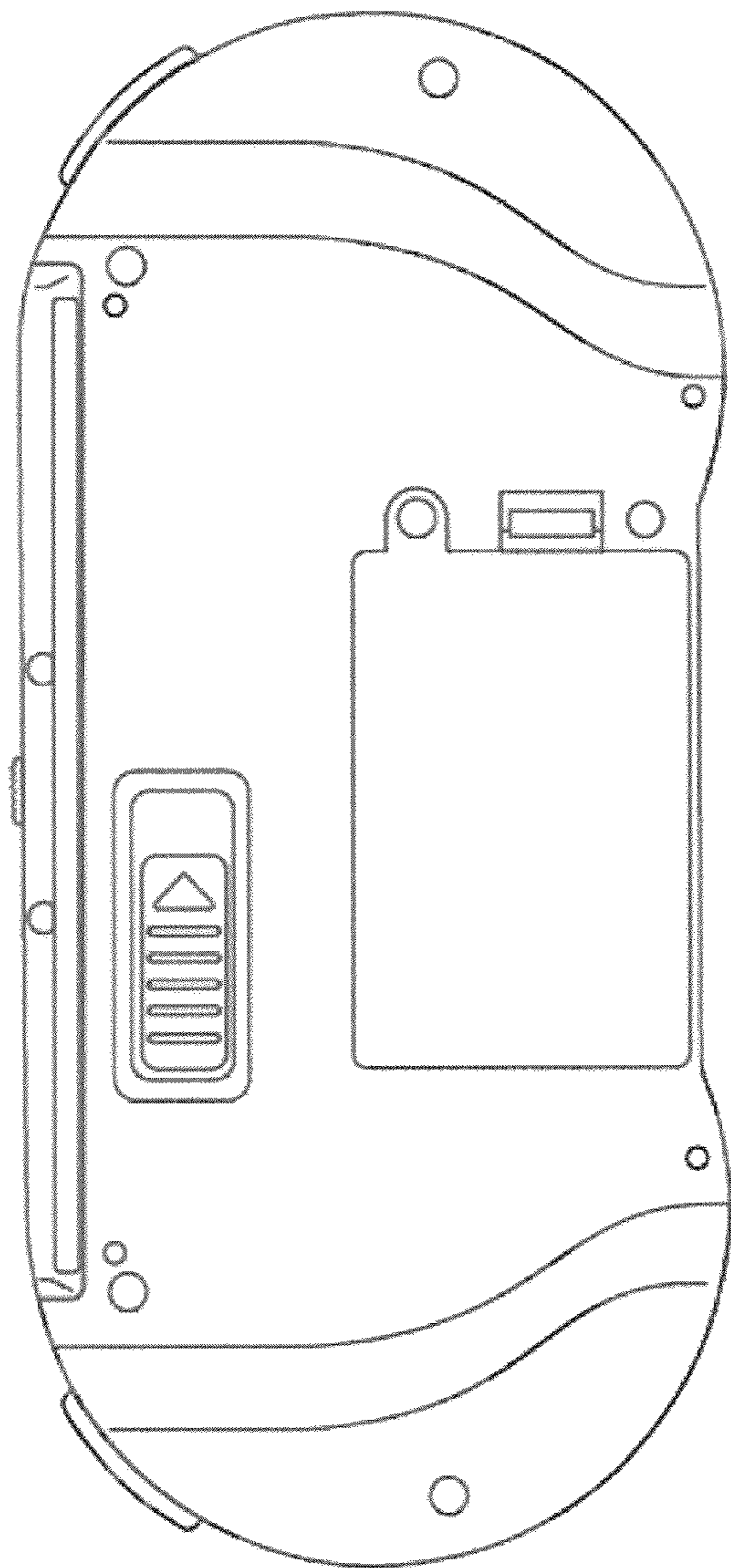

FIG. 4

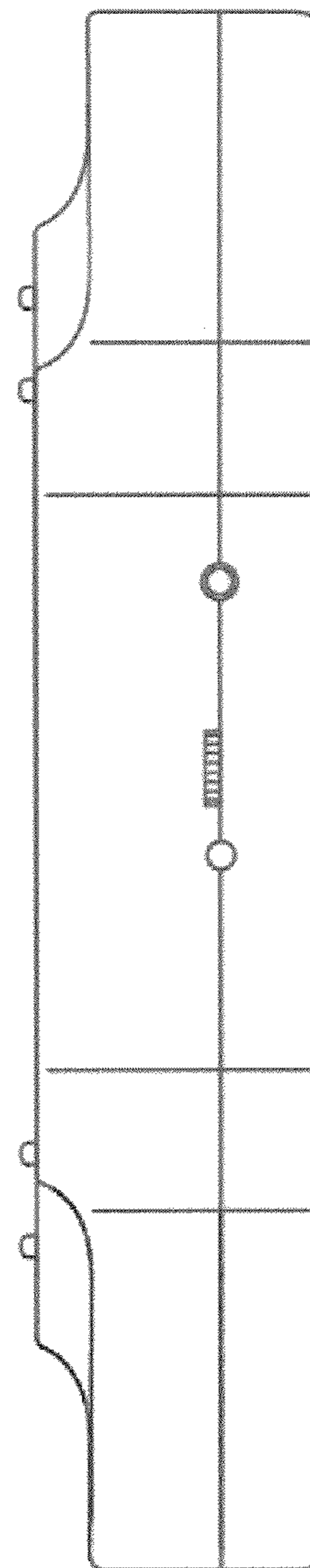

FIG. 5

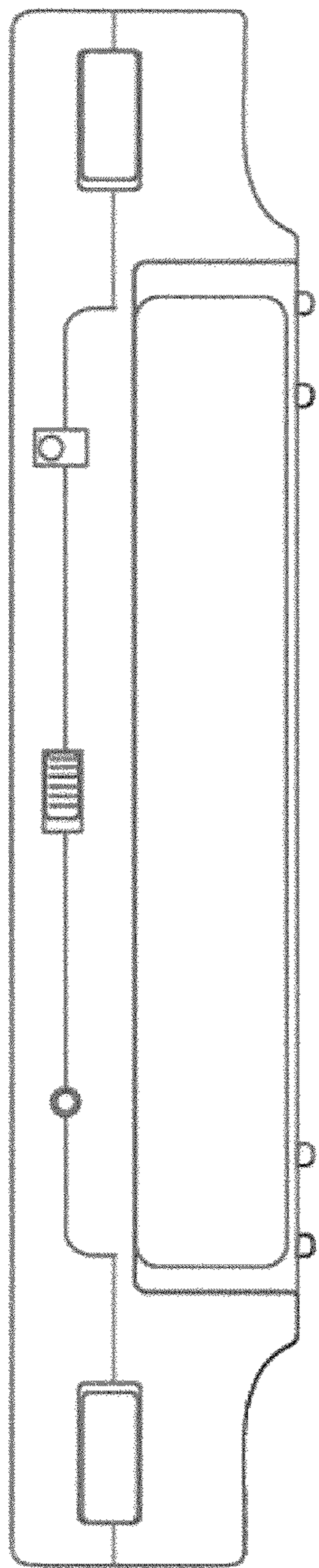

FIG. 6

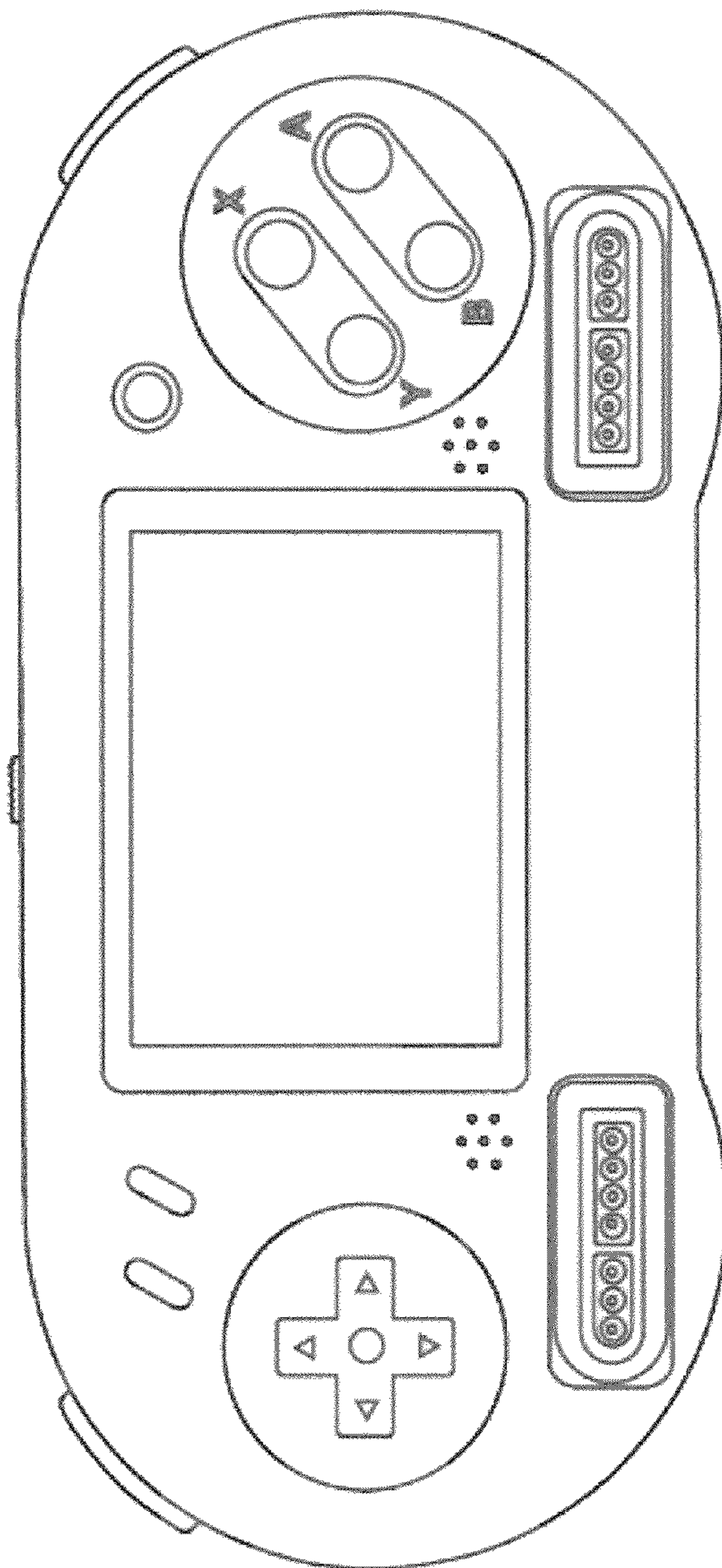

FIG. 8

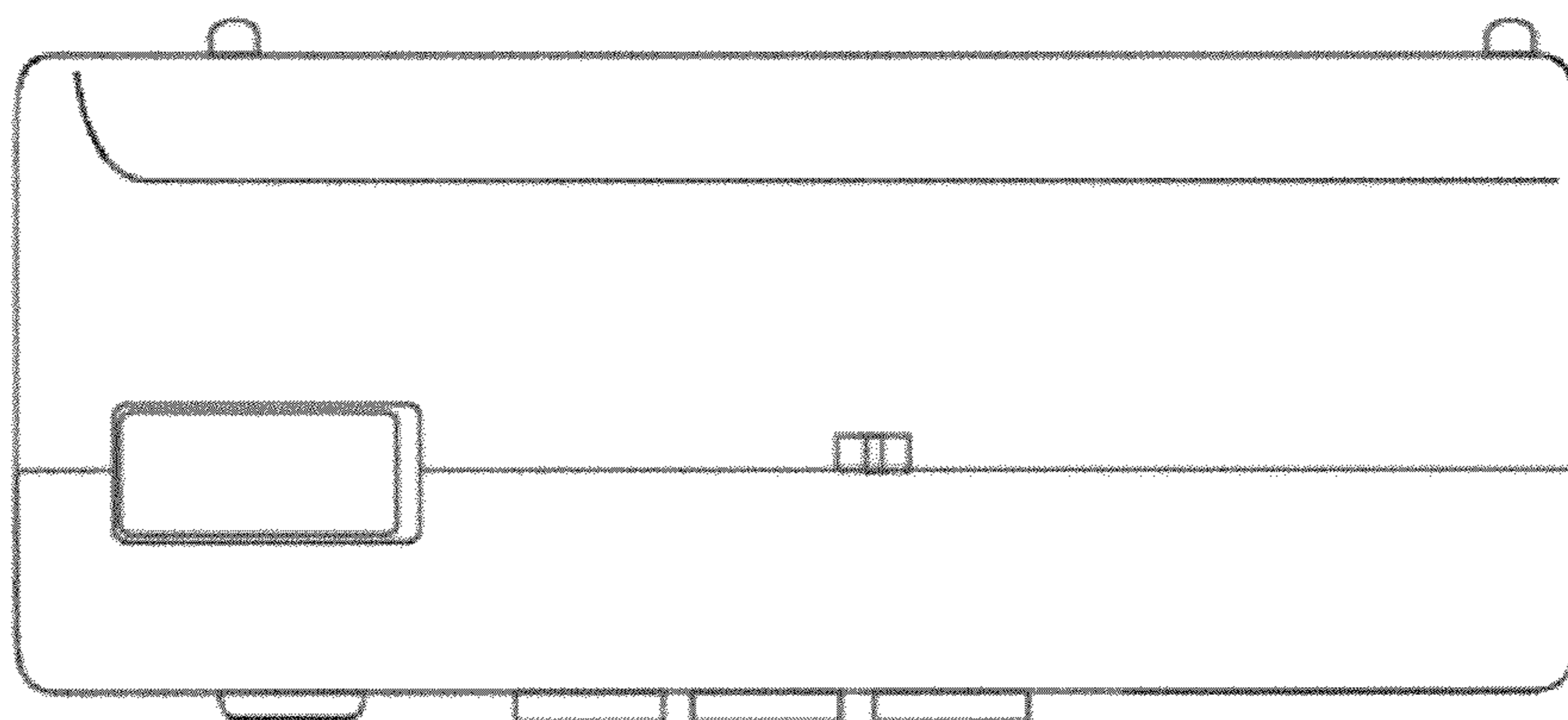

FIG. 7

