

US00D656536S

(12) **United States Design Patent**
Auroux et al.

(10) **Patent No.:** **US D656,536 S**
(45) **Date of Patent:** **** Mar. 27, 2012**

(54) **ENVELOPE OPENING APPARATUS**

(75) Inventors: **Michel Auroux**, Taulignan (FR);
Alexandre Para, Valreas (FR)

(73) Assignee: **Silcap**, Anse (FR)

(**) Term: **14 Years**

(21) Appl. No.: **29/391,974**

(22) Filed: **May 16, 2011**

(30) **Foreign Application Priority Data**

Nov. 18, 2010 (EM) 001245377-0001

(51) **LOC (9) Cl.** **16-03**

(52) **U.S. Cl.** **D18/46; D18/51**

(58) **Field of Classification Search** D18/36-41,
D18/44-56; 222/DIG. 1; 271/3.14, 8.1,
271/226, 278; 355/97, 99; 358/1.1; 399/1-7,
399/16, 75, 81, 107, 130, 151, 361, 365,
399/367, 381-383, 388

See application file for complete search history.

(56) **References Cited**

U.S. PATENT DOCUMENTS

D422,874 S * 4/2000 Forbes D18/46
D464,991 S * 10/2002 Sugrue et al. D18/51
D464,992 S * 10/2002 Sugrue et al. D18/51
D478,121 S * 8/2003 Forbes D18/46
D488,501 S * 4/2004 Brooks et al. D18/51

D502,962 S * 3/2005 Brooks et al. D18/51
D526,008 S * 8/2006 Friedrich et al. D18/51
D529,079 S * 9/2006 Sugrue et al. D18/51
D529,544 S * 10/2006 Friedrich et al. D18/51

OTHER PUBLICATIONS

Photographs (2) and product sheet of Pitney-Bowles OL-400 Semi Automatic Letter Opener (commercialized circa 1990s).

* cited by examiner

Primary Examiner — Garth Rademaker

(74) *Attorney, Agent, or Firm* — Marshall, Gerstein & Borun LLP; Richard M. LaBarge

(57) **CLAIM**

The ornamental design for an envelope opening apparatus, as shown and described.

DESCRIPTION

FIG. 1 is a front, top, and left side perspective view of an envelope opening apparatus showing the new design; FIG. 2 is a back, top, and right side perspective view thereof; FIG. 3 is a front, bottom, and right side perspective view thereof;

FIG. 4 is a left side elevation thereof;

FIG. 5 is a right side elevation view thereof;

FIG. 6 is a front elevation view thereof; and,

FIG. 7 is a top plan view thereof.

The elements seen in broken lines are not part of the claimed design.

1 Claim, 7 Drawing Sheets

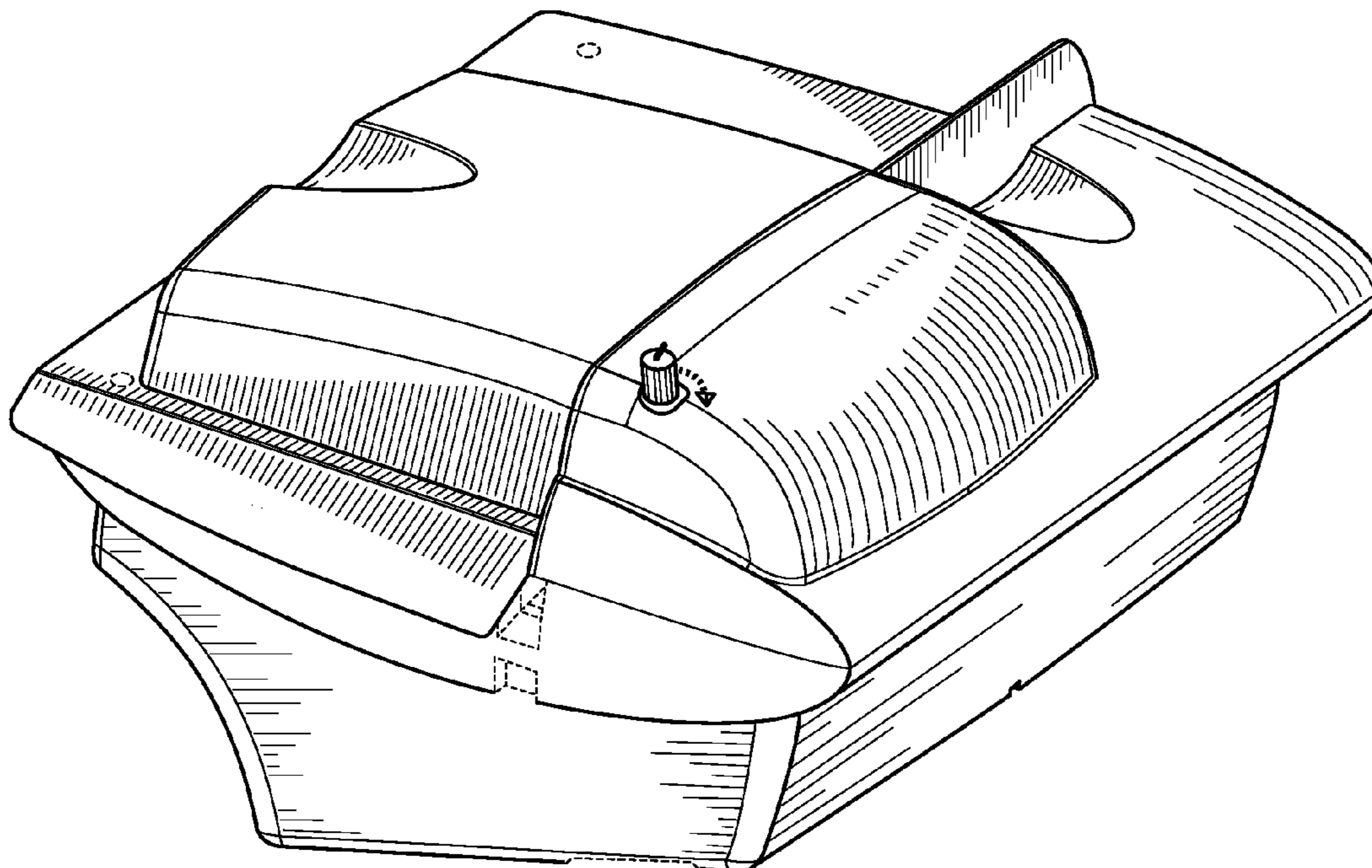

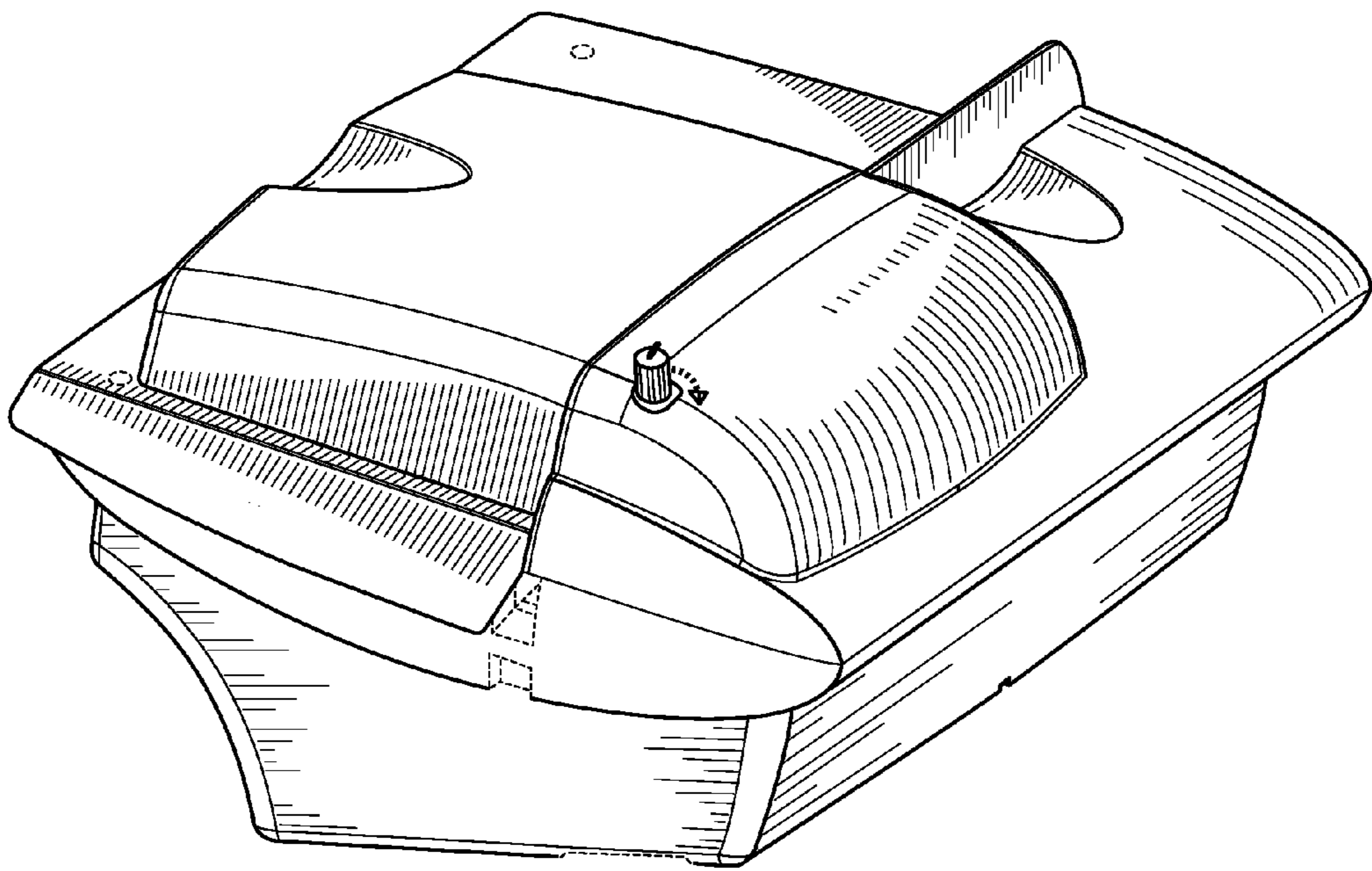

FIG. 1

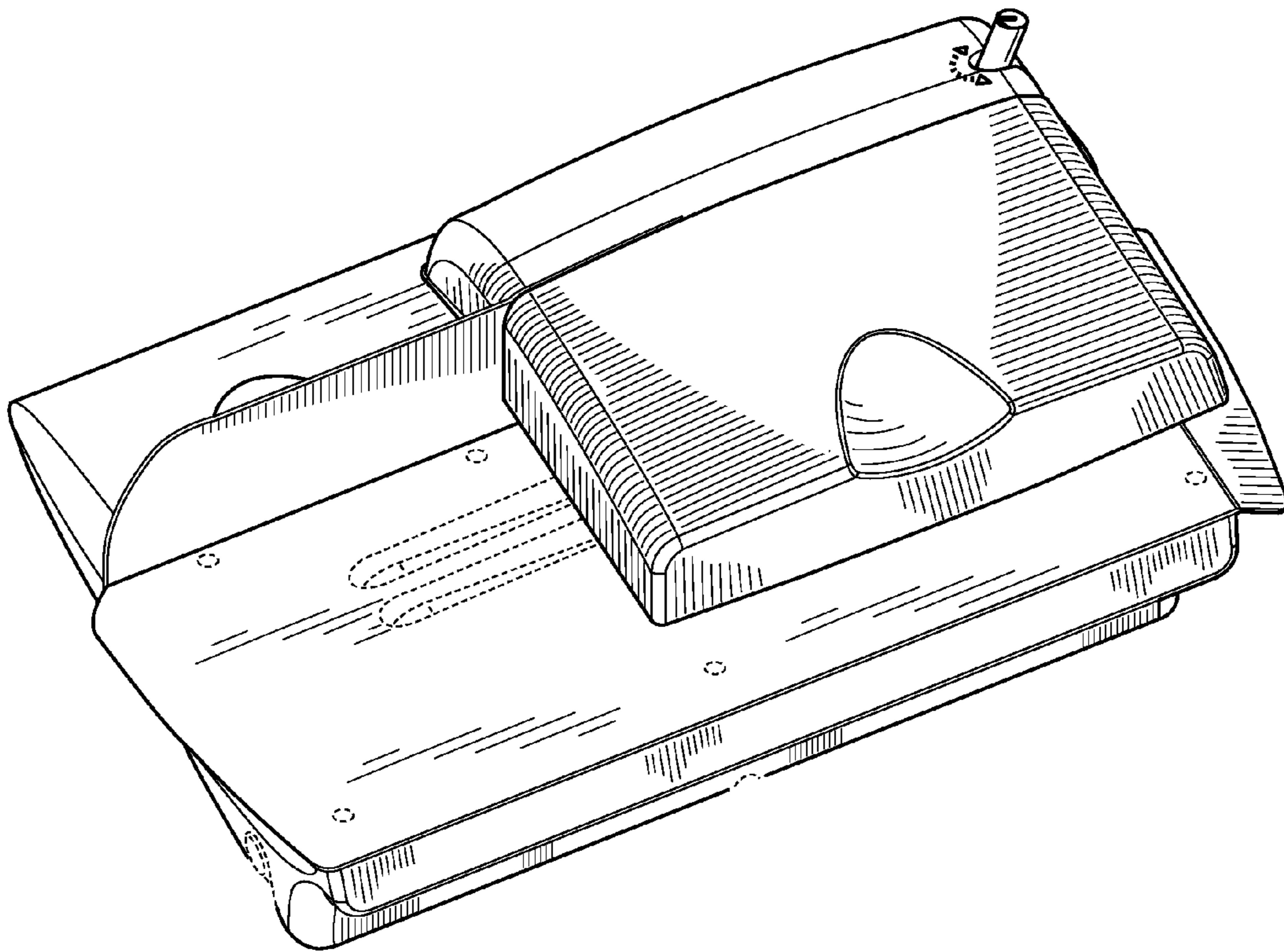

FIG. 2

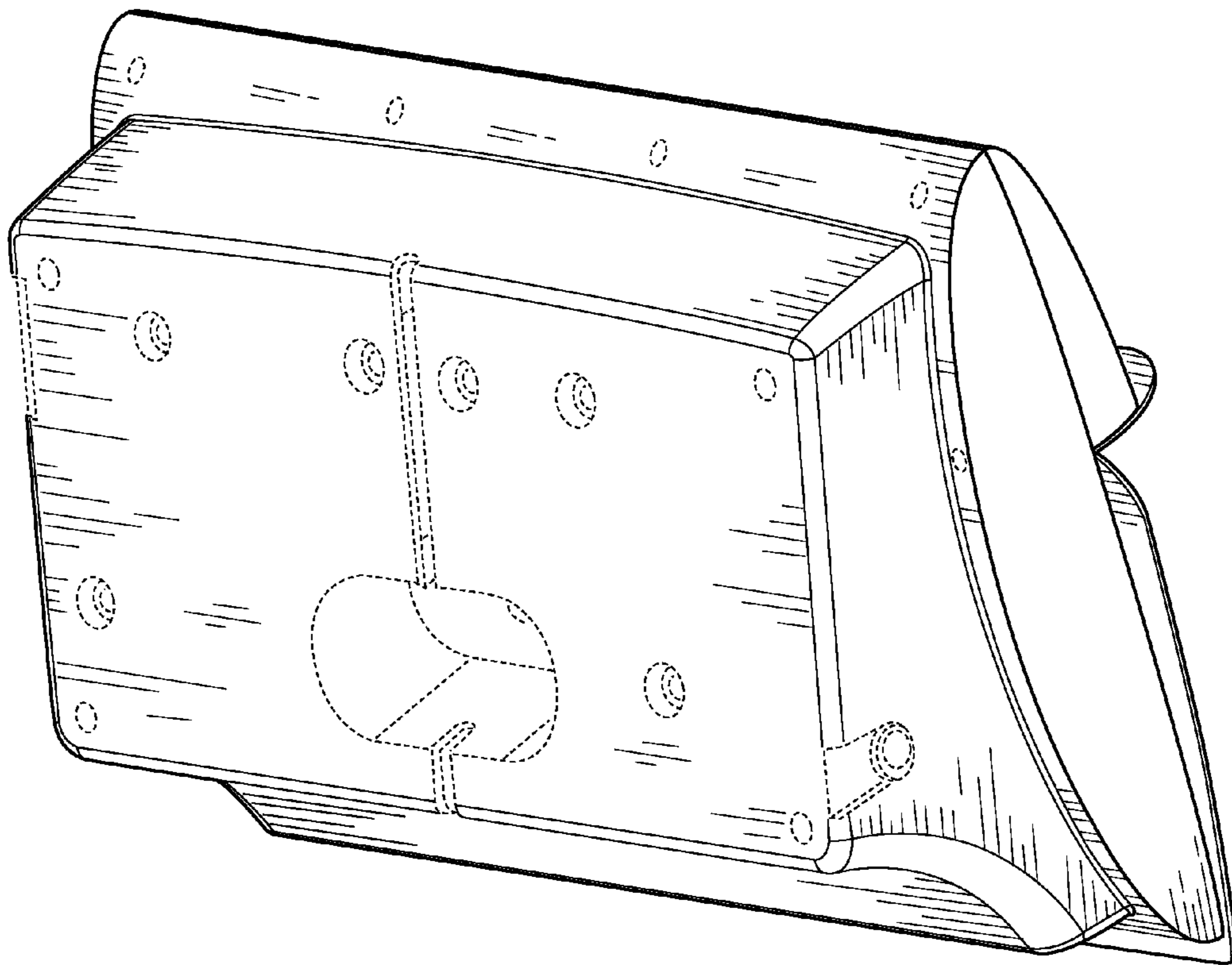

FIG. 3

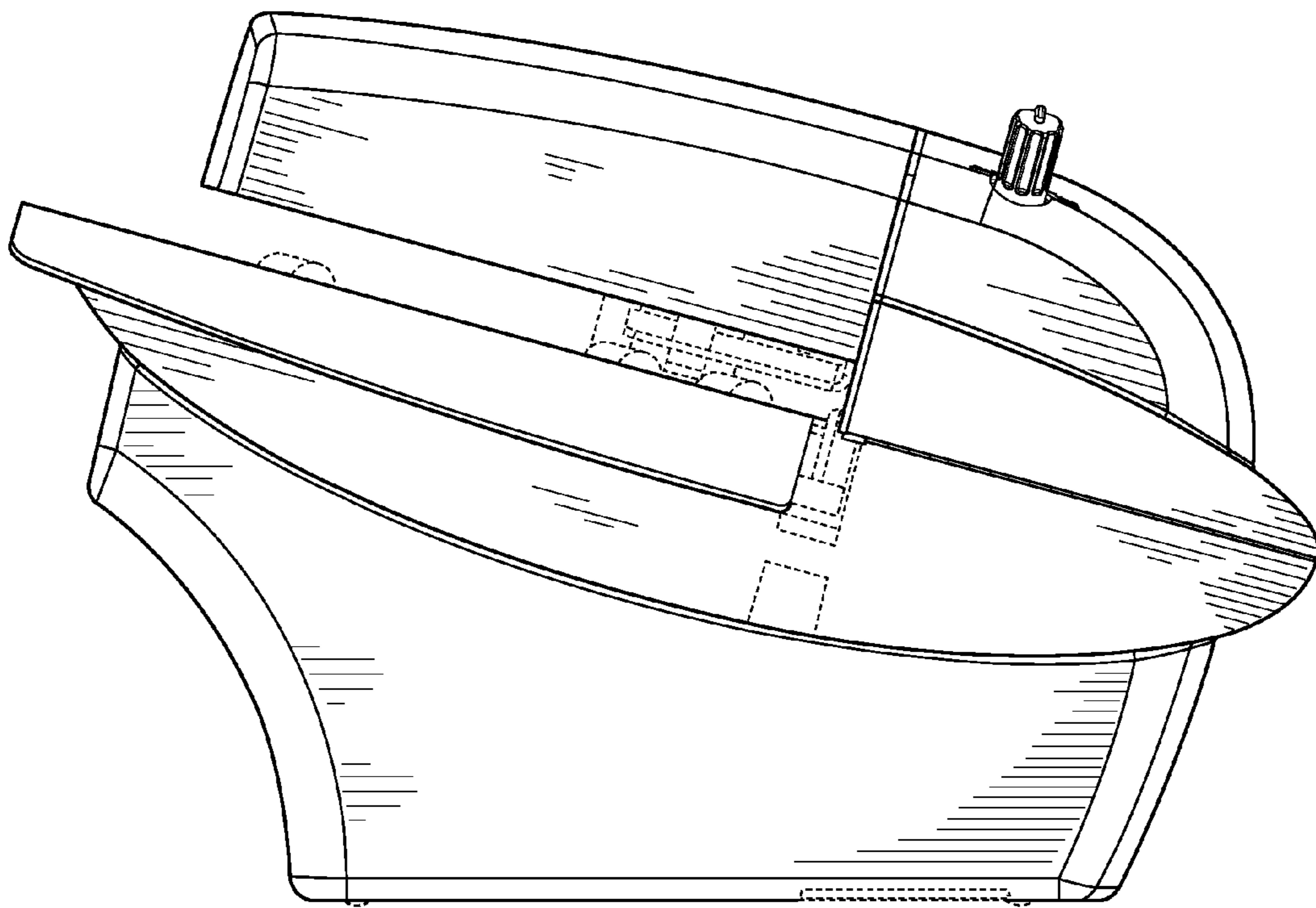

FIG. 4

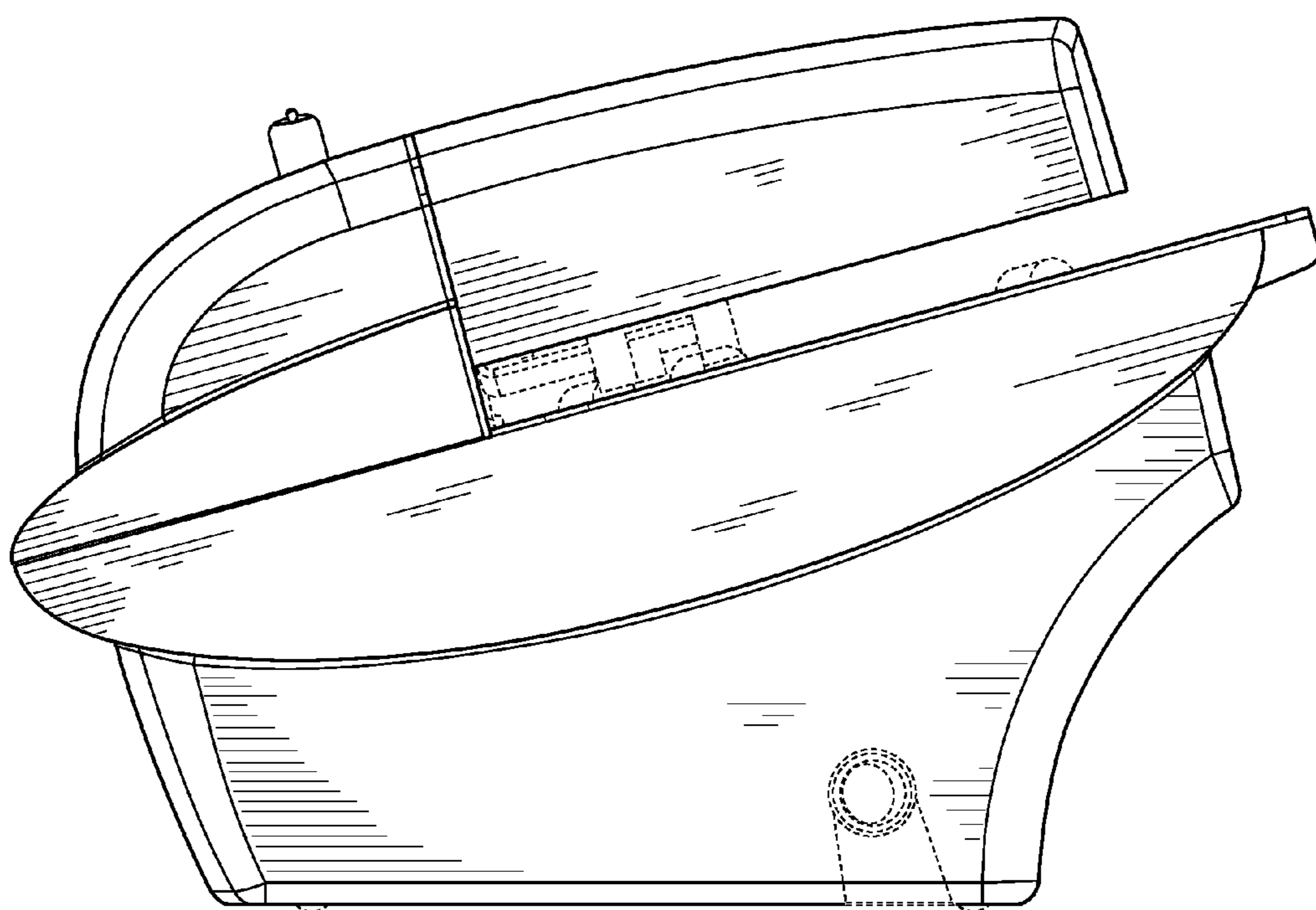

FIG. 5

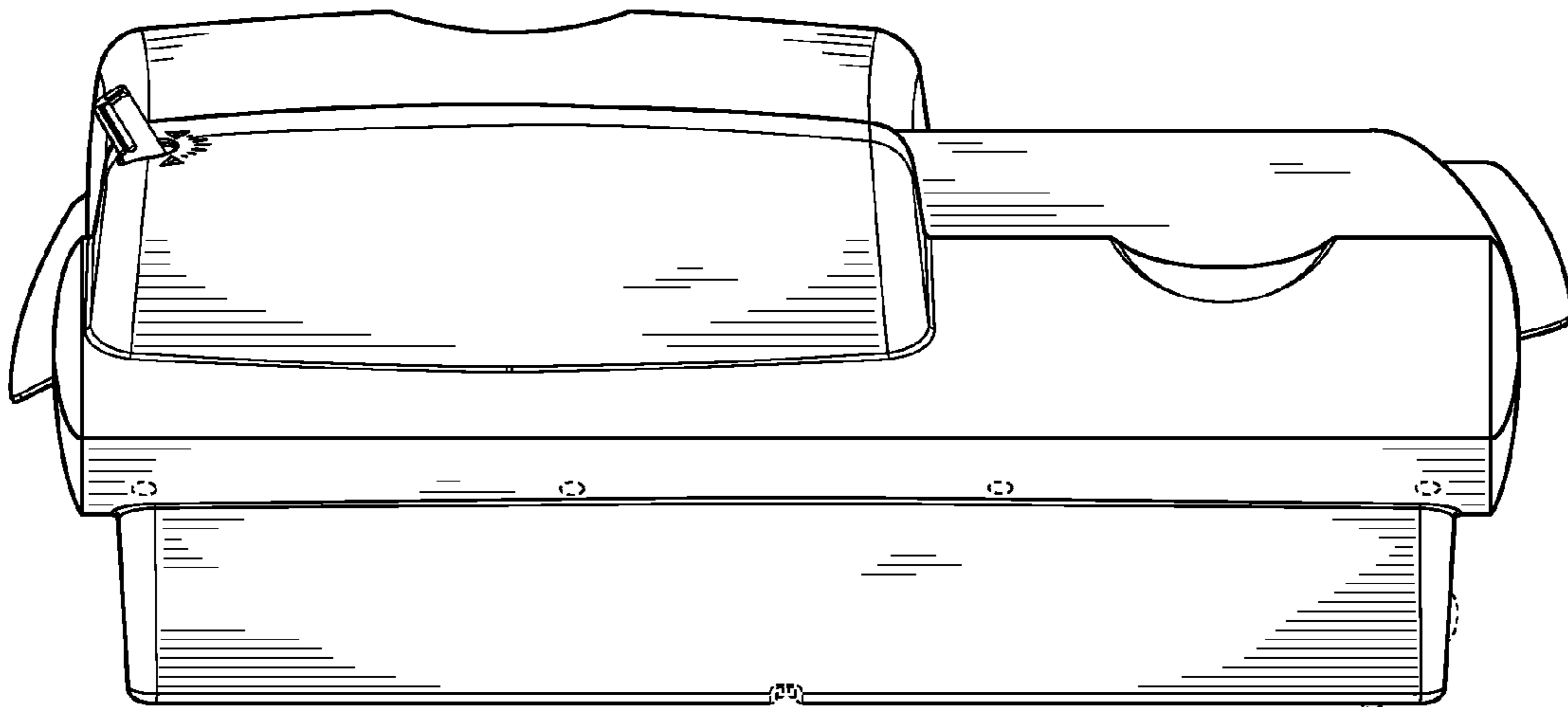

FIG. 6

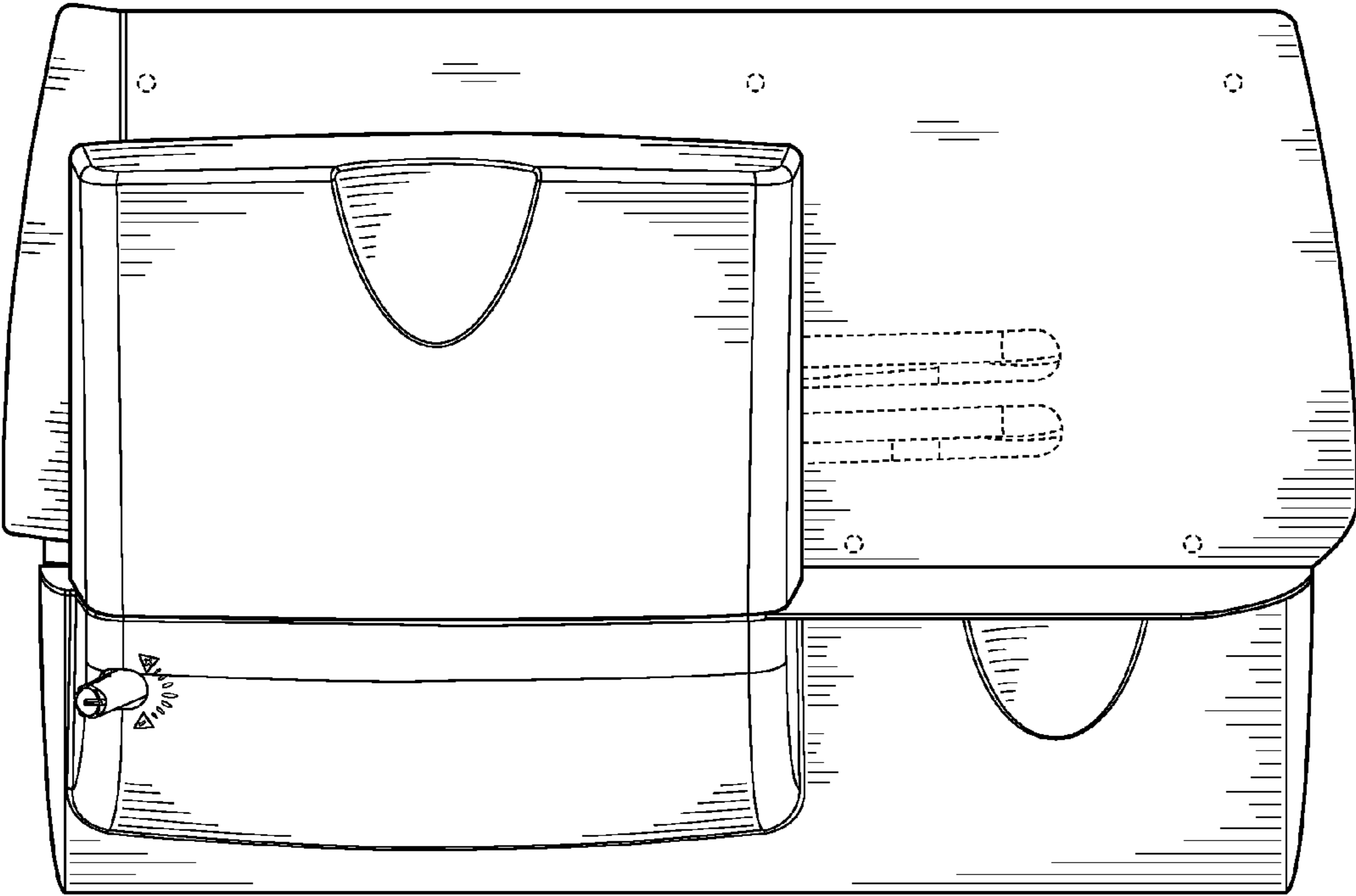

FIG. 7