



US00D656505S

(12) **United States Design Patent**
Jones et al.

(10) **Patent No.:** **US D656,505 S**
(45) **Date of Patent:** **** Mar. 27, 2012**

- (54) **DISPLAY SCREEN PORTION WITH ANIMATED IMAGE**
 - (75) Inventors: **Boland T. Jones**, Atlanta, GA (US); **David Michael Guthrie**, Atlanta, GA (US); **Erik Petrik**, Austin, TX (US)
 - (73) Assignee: **American Teleconferencing Services, Ltd.**, Atlanta, GA (US)
 - (**) Term: **14 Years**
 - (21) Appl. No.: **29/360,777**
 - (22) Filed: **Apr. 30, 2010**
 - (51) **LOC (9) Cl.** **32-00**
 - (52) **U.S. Cl.** **D14/485**
 - (58) **Field of Classification Search** D14/485-495;
715/700-867
- See application file for complete search history.

(56) **References Cited**

U.S. PATENT DOCUMENTS

5,544,291	A	8/1996	Gilley	
5,737,452	A	4/1998	Schiller	
5,745,666	A	4/1998	Gilley	
D395,426	S *	6/1998	Chiba	D14/486
D396,854	S *	8/1998	Tullis	D14/486
D398,594	S *	9/1998	Tullis	D14/486
D398,595	S *	9/1998	Baer et al.	D14/486
5,930,396	A	7/1999	Fiala	
6,049,339	A	4/2000	Schiller	
6,067,094	A	5/2000	Schuster	
6,072,502	A	6/2000	Gupta	
6,167,432	A	12/2000	Jiang	
6,208,355	B1	3/2001	Schuster	
6,233,389	B1	5/2001	Barton	
6,262,745	B1	7/2001	Perani	
6,278,478	B1	8/2001	Ferriere	
6,279,028	B1	8/2001	Bradshaw, Jr.	
6,304,677	B1	10/2001	Schuster	
6,411,742	B1	6/2002	Peterson	
6,477,240	B1	11/2002	Lim	
6,567,813	B1	5/2003	Zhu	
6,574,599	B1	6/2003	Lim	
6,584,493	B1	6/2003	Butler	
6,598,075	B1	7/2003	Johnson	
6,601,087	B1	7/2003	Zhu	
6,643,362	B2	11/2003	Hogan	
6,646,655	B1	11/2003	Brandt	
6,654,032	B1	11/2003	Zhu	
6,691,154	B1	2/2004	Zhu	
6,721,446	B1	4/2004	Wilensky	

(Continued)

Primary Examiner — Joel Sincavage
Assistant Examiner — Deanna Fluegeman
(74) *Attorney, Agent, or Firm* — Robert A. Blaha; Smith Riskey Tempel Santos LLC

(57) **CLAIM**
The ornamental design for a display screen portion with an animated image, as shown and described.

DESCRIPTION

A portion of the disclosure of this patent document contains material to which a claim for copyright is made. The copyright owner has no objection to the facsimile reproduction by anyone of the patent document or the patent disclosure, as it appears in the Patent and Trademark Office patent file or records, but reserves all other copyright rights whatsoever. FIG. 1 is a first image in the sequence for a display screen portion with an animated image showing our new design; FIG. 2 is the second image thereof; FIG. 3 is the third image thereof; FIG. 4 is the fourth image thereof; FIG. 5 is the fifth image thereof; FIG. 6 is the sixth image thereof; FIG. 7 is the seventh image thereof; FIG. 8 is the eighth image thereof; FIG. 9 is the ninth image thereof; FIG. 10 is the tenth image thereof; FIG. 11 is the eleventh image thereof; FIG. 12 is the twelfth image thereof; FIG. 13 is the thirteenth image thereof; FIG. 14 is the fourteenth image thereof; FIG. 15 is the fifteenth image thereof; FIG. 16 is the sixteenth image thereof; FIG. 17 is the seventeenth image thereof; FIG. 18 is the eighteenth image thereof; FIG. 19 is the nineteenth image thereof; FIG. 20 is the twentieth image thereof; FIG. 21 is the twenty-first image thereof; FIG. 22 is the twenty-second image thereof; and, FIG. 23 is the twenty-third image thereof.

The claimed design is an integral and active component in the operation of a computer-programmed device displaying the design. The appearance of the animated image sequentially transitions between the images shown in FIGS. 1-23. The process or period in which one image transitions to another image forms no part of the claimed design. The broken line showing of the display screen and the broken line showing of the portions of the user interface are included for the purpose of illustrating unclaimed environment and form no part of the claimed design.

1 Claim, 23 Drawing Sheets

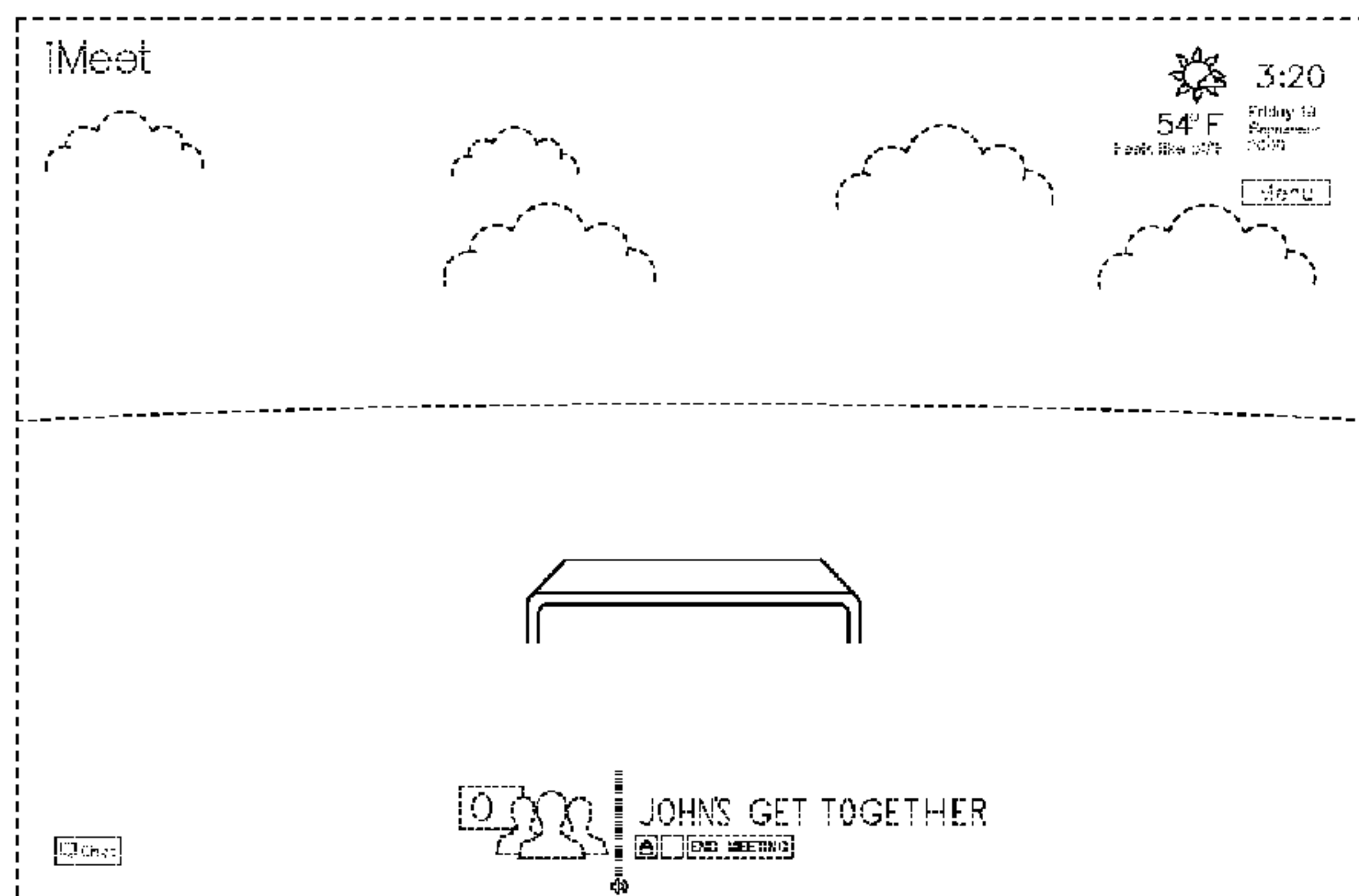

© American Teleconferencing Services, Ltd.

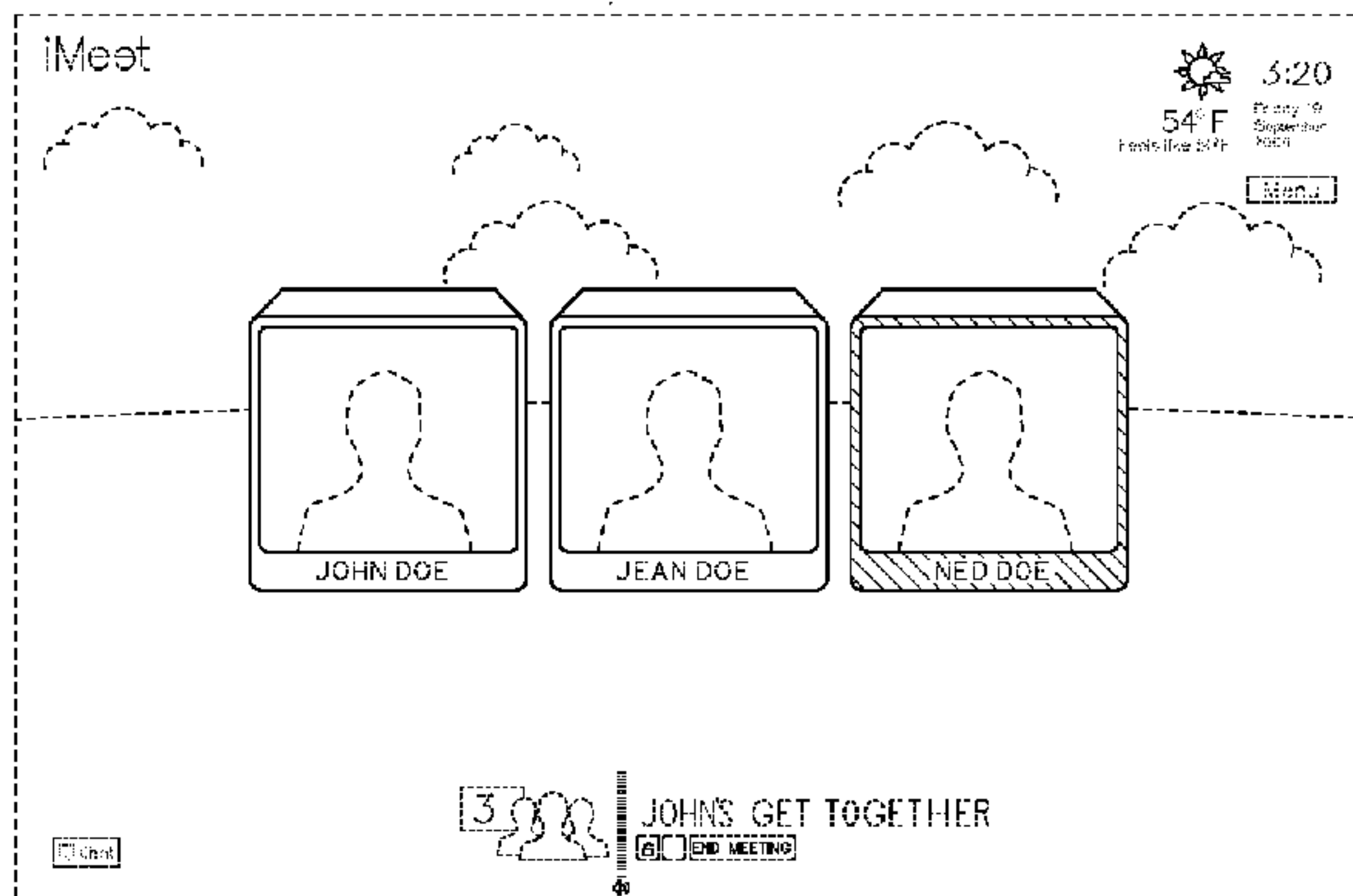

© American Teleconferencing Services, Ltd.

US D656,505 S

Page 2

U.S. PATENT DOCUMENTS							
6,763,501	B1	7/2004	Zhu	D575,798	S *	8/2008	Nathan et al. D14/489
6,771,303	B2	8/2004	Zhang	D576,635	S *	9/2008	Nathan et al. D14/488
6,789,119	B1	9/2004	Zhu	7,421,069	B2	9/2008	Vernon
6,891,929	B2	5/2005	Yang	7,421,114	B1	9/2008	Brandt
6,901,448	B2	5/2005	Zhu	7,426,297	B2	9/2008	Zhang
6,925,645	B2	8/2005	Zhu	7,426,578	B2	9/2008	Jones
6,954,216	B1	10/2005	Dowling	7,428,330	B2	9/2008	Blake
6,961,736	B1	11/2005	Amirghodsi	D578,544	S *	10/2008	Nathan et al. D14/488
6,968,179	B1	11/2005	De Vries	7,471,849	B2	12/2008	Peterson
6,988,132	B2	1/2006	Horvitz	D588,606	S *	3/2009	Nathan et al. D14/488
6,990,252	B2	1/2006	Shekter	7,512,262	B2	3/2009	Criminisi
7,003,061	B2	2/2006	Wilensky	7,512,883	B2	3/2009	Wallick
7,006,707	B2	2/2006	Peterson	7,515,173	B2	4/2009	Zhang
7,023,800	B1	4/2006	McAuley	7,518,623	B2	4/2009	Dowling
7,069,298	B2	6/2006	Zhu	7,518,631	B2	4/2009	Hershey
7,093,200	B2 *	8/2006	Schreiber et al. 715/835	7,529,798	B2	5/2009	Rust
7,095,905	B1	8/2006	Peterson	D593,578	S *	6/2009	Ball et al. D14/488
7,103,236	B2	9/2006	Peterson	D594,020	S *	6/2009	Ball et al. D14/486
7,130,883	B2	10/2006	Zhu	D594,021	S *	6/2009	Ball et al. D14/486
7,136,062	B1	11/2006	Butler	D594,025	S *	6/2009	Ball et al. D14/488
7,143,132	B2	11/2006	Klein et al.	D594,026	S *	6/2009	Ball et al. D14/488
7,146,577	B2	12/2006	Hoffman	D594,468	S *	6/2009	Bamford et al. D14/488
7,158,616	B2	1/2007	Yang	D599,369	S *	9/2009	Murchie et al. D14/485
7,167,182	B2	1/2007	Butler	D599,370	S *	9/2009	Murchie et al. D14/485
7,184,602	B2	2/2007	Cohen et al.	D599,806	S *	9/2009	Brown et al. D14/485
7,184,682	B2	2/2007	Chadani et al.	D599,812	S *	9/2009	Hirsch D14/488
7,200,213	B2	4/2007	Morris	D599,813	S *	9/2009	Hirsch D14/488
7,203,755	B2	4/2007	Zhu	D600,249	S *	9/2009	Nagata et al. D14/486
7,213,051	B2	5/2007	Zhu	7,583,287	B2	9/2009	Cohen
7,216,147	B2	5/2007	Blagsvedt	7,587,509	B1	9/2009	Edelman
7,216,172	B2	5/2007	Yang	7,596,498	B2	9/2009	Basu
7,228,332	B2	6/2007	Rust	D602,027	S *	10/2009	Queric D14/485
7,236,926	B2	6/2007	Scherpbier	D602,028	S *	10/2009	Queric D14/485
7,260,278	B2	8/2007	Zhang	7,599,572	B2	10/2009	Shekter
RE39,830	E *	9/2007	Balabanovic 345/419	D603,415	S *	11/2009	Lin et al. D14/485
7,272,658	B1	9/2007	Edelman	D605,200	S *	12/2009	Sakai D14/486
7,302,594	B2	11/2007	Di Benedetto	D607,889	S *	1/2010	Poling et al. D14/485
7,313,595	B2	12/2007	Rust	D608,364	S *	1/2010	Walsh et al. D14/485
7,317,826	B2	1/2008	Wilensky	D608,365	S *	1/2010	Walsh et al. D14/485
7,328,239	B1	2/2008	Berberian	7,675,514	B2 *	3/2010	Ni et al. 345/419
7,346,631	B2	3/2008	Amirghodsi	D623,657	S *	9/2010	Fitzmaurice et al. D14/488
7,349,944	B2	3/2008	Vernon	2002/0033848	A1 *	3/2002	Sciammarella et al. 345/838
7,352,858	B2	4/2008	Stokes	2006/0089949	A1	4/2006	Robbin
7,355,622	B2	4/2008	Clarke	2006/0123052	A1	6/2006	Robbin
7,355,623	B2	4/2008	Cutler	2006/0168545	A1 *	7/2006	Niittynen et al. 715/848
7,360,152	B2	4/2008	Capps	2007/0111716	A1	5/2007	Leigh
7,360,172	B2	4/2008	Grossman	2008/0008458	A1	1/2008	Gudipaty
7,362,350	B2	4/2008	Cutler	2008/0238916	A1 *	10/2008	Ghosh et al. 345/419
7,373,381	B2	5/2008	Rust	2008/0313714	A1	12/2008	Fetterman
7,386,188	B2	6/2008	Peterson	2009/0106347	A1	4/2009	Harwood
7,386,784	B2	6/2008	Capps	2009/0144392	A1	6/2009	Wang
7,389,351	B2	6/2008	Horvitz	2009/0144837	A1	6/2009	Huff
7,395,312	B2	7/2008	Kothari	2009/0180763	A1	7/2009	McCarthy
7,398,295	B2	7/2008	Shoroff	2009/0259959	A1	10/2009	Grotjohn
D575,797	S *	8/2008	Nathan et al. D14/489	2009/0296535	A1	12/2009	Jones

* cited by examiner

FIG. 1

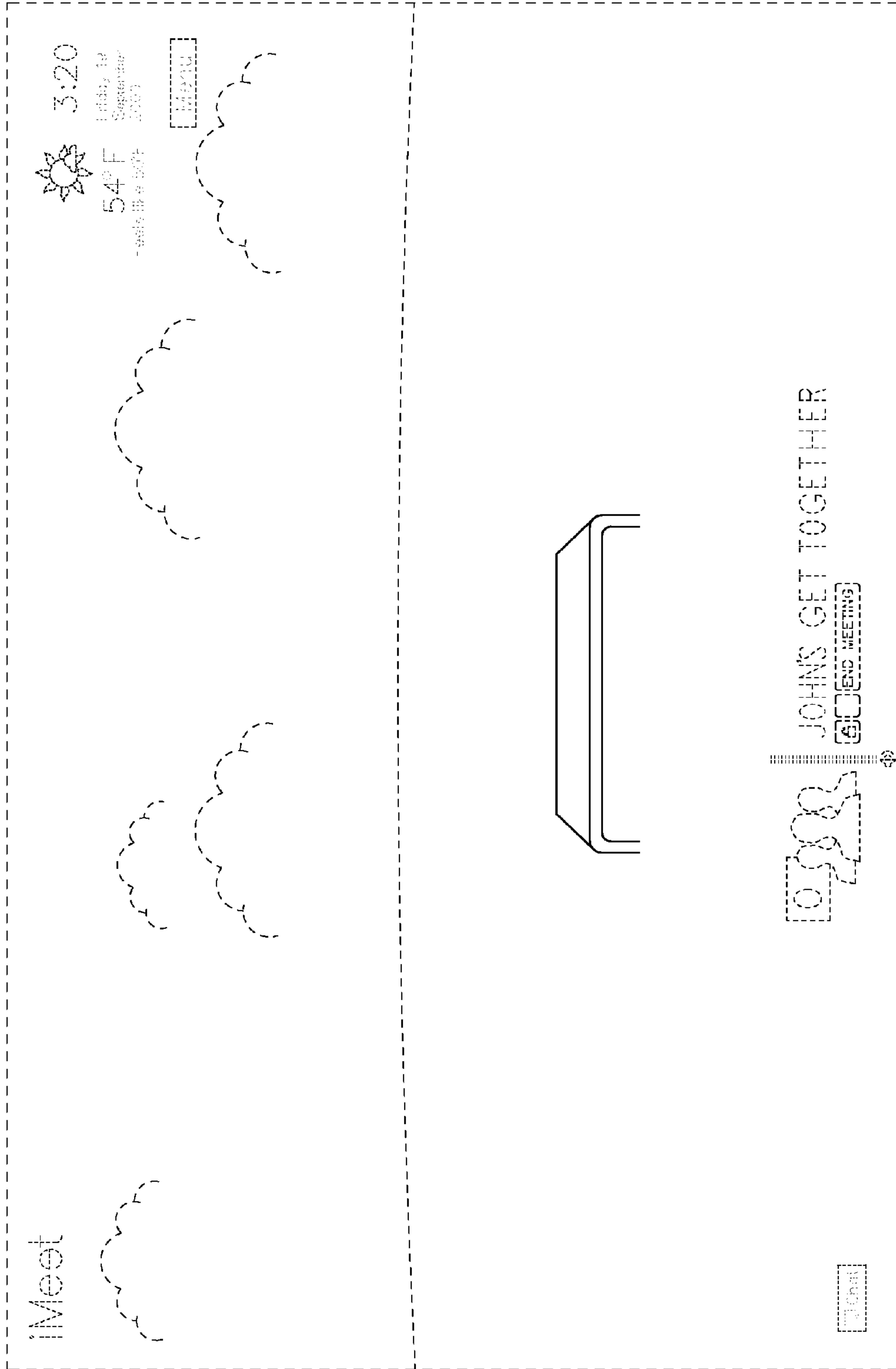

FIG. 2

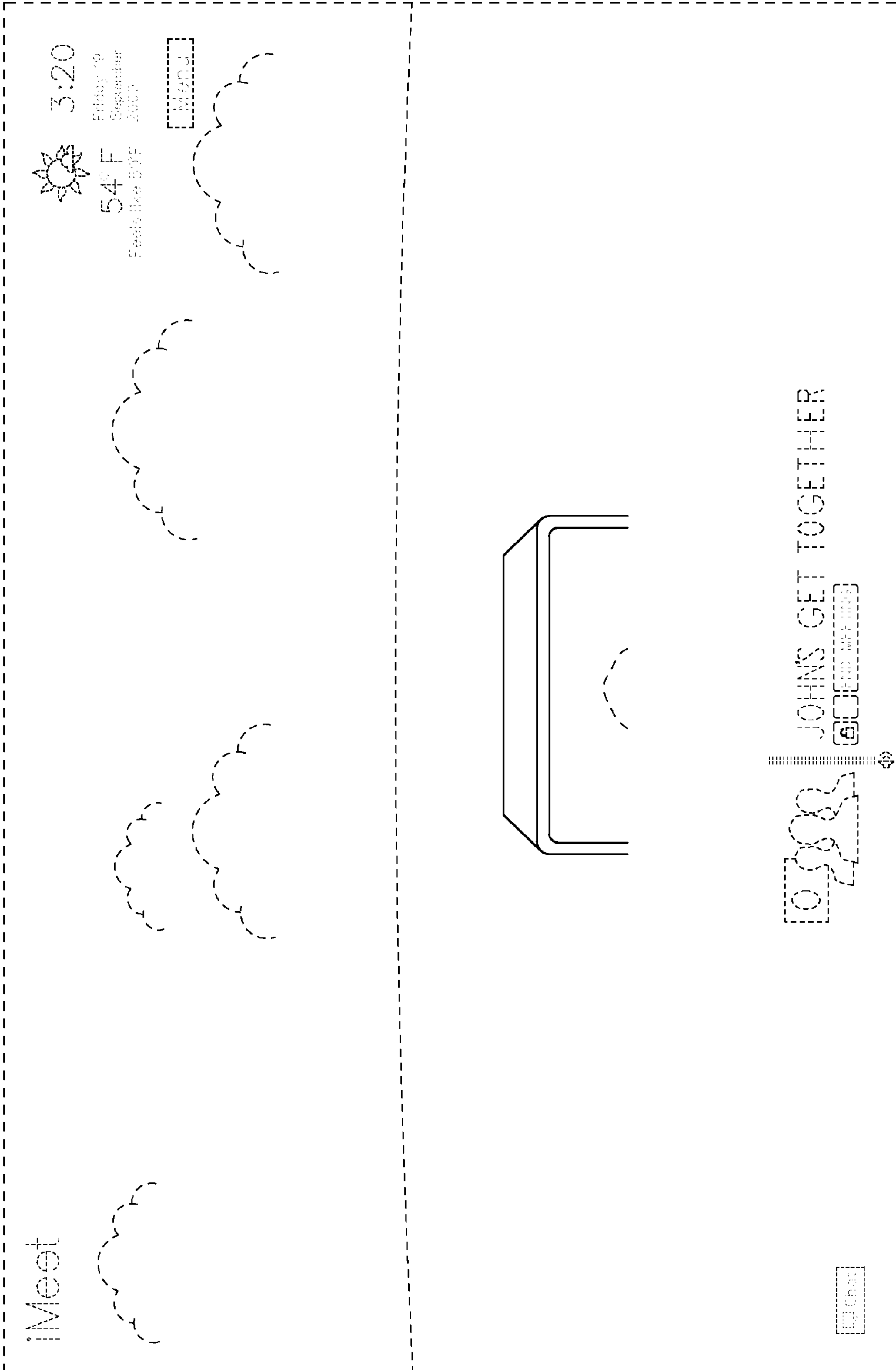

FIG. 3

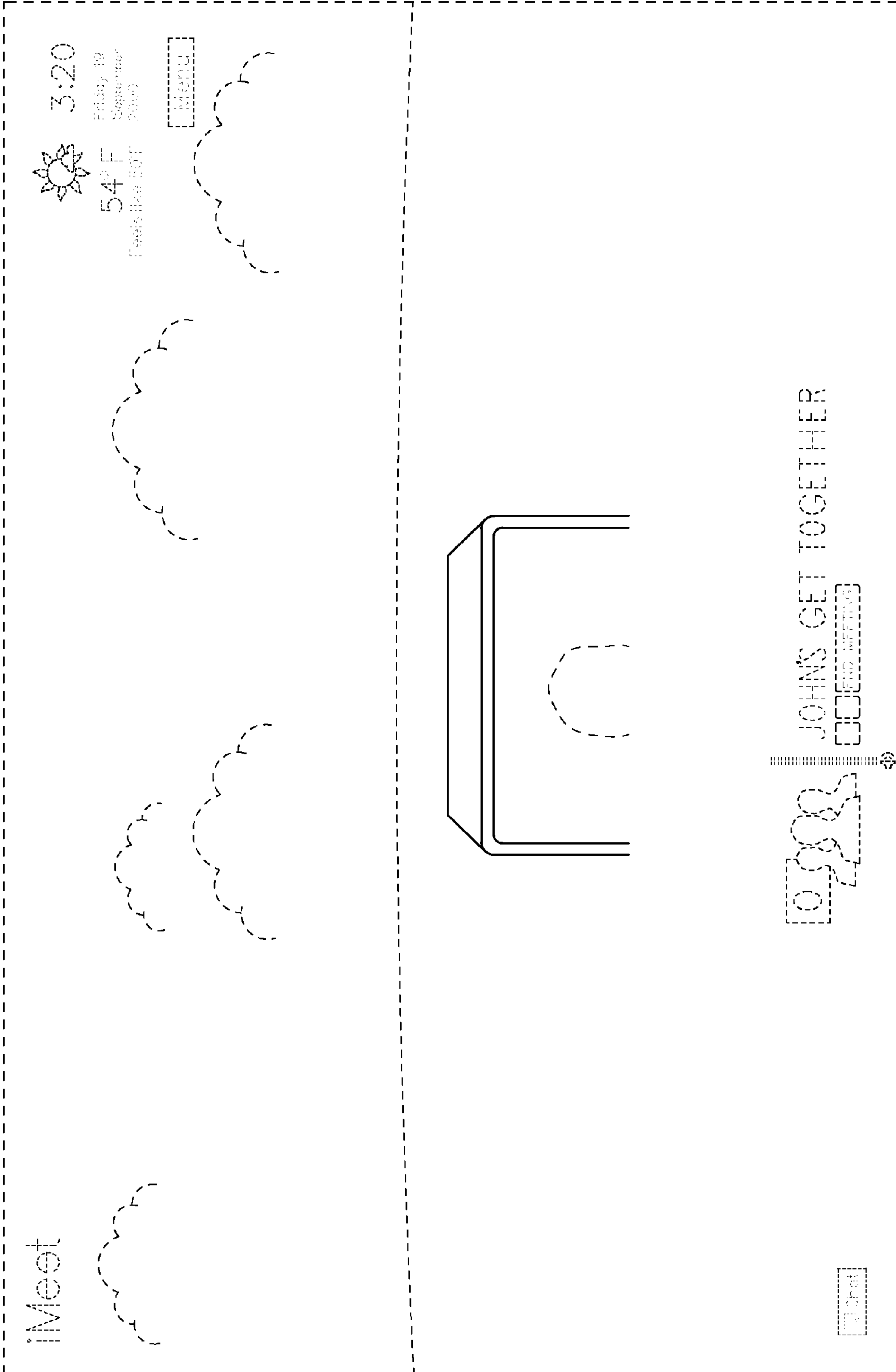

FIG. 4

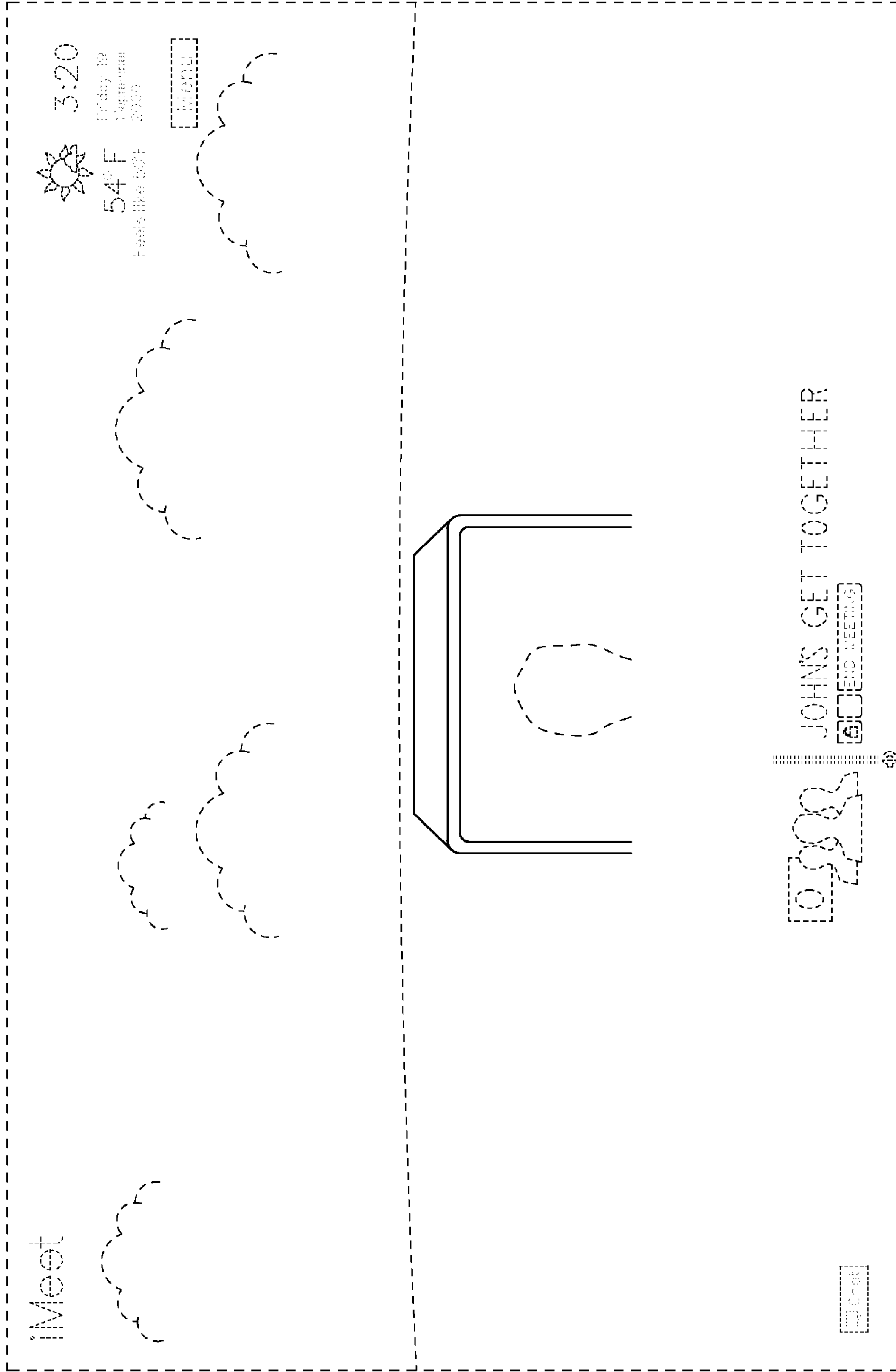

FIG. 5

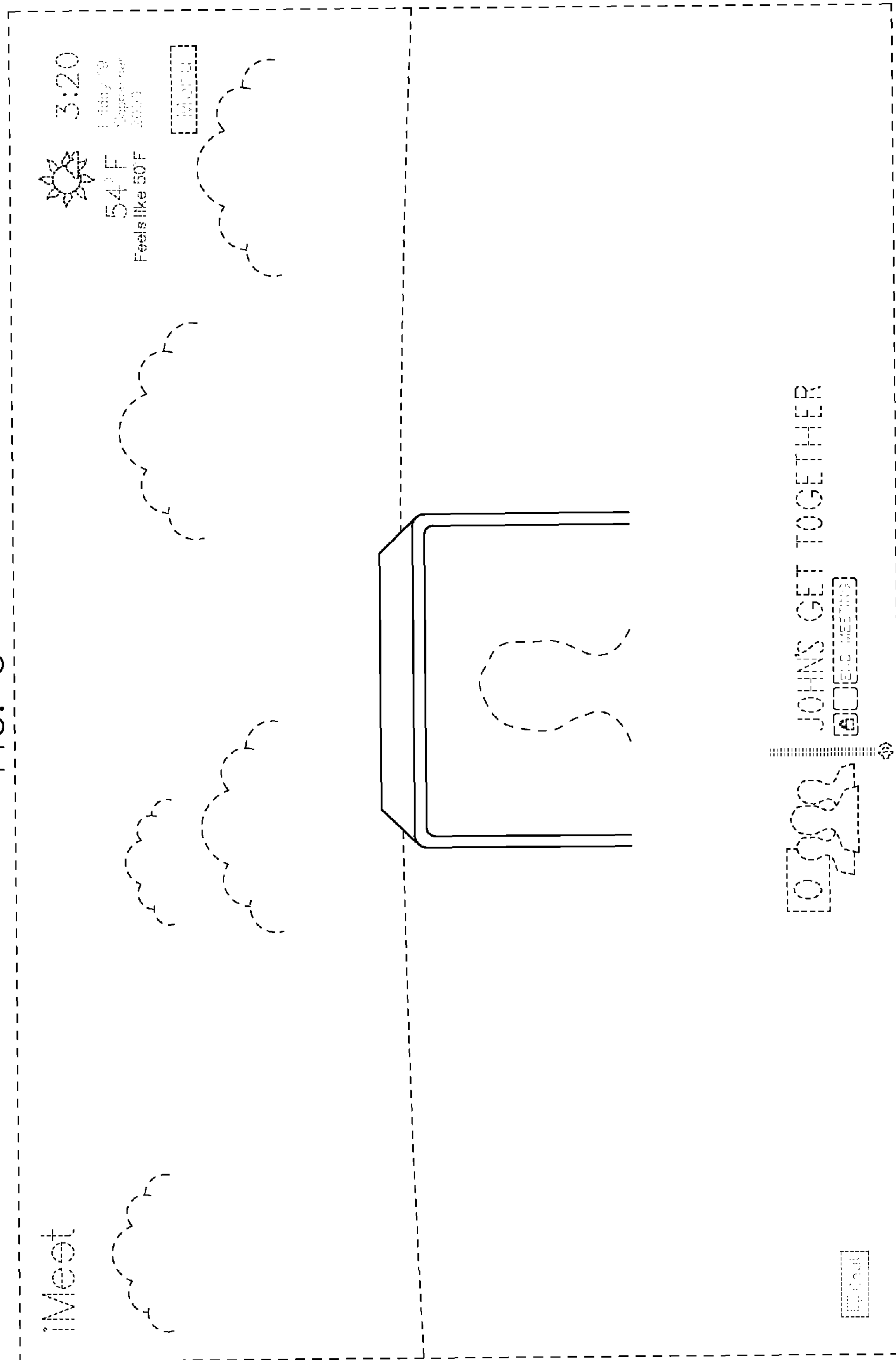

FIG. 6

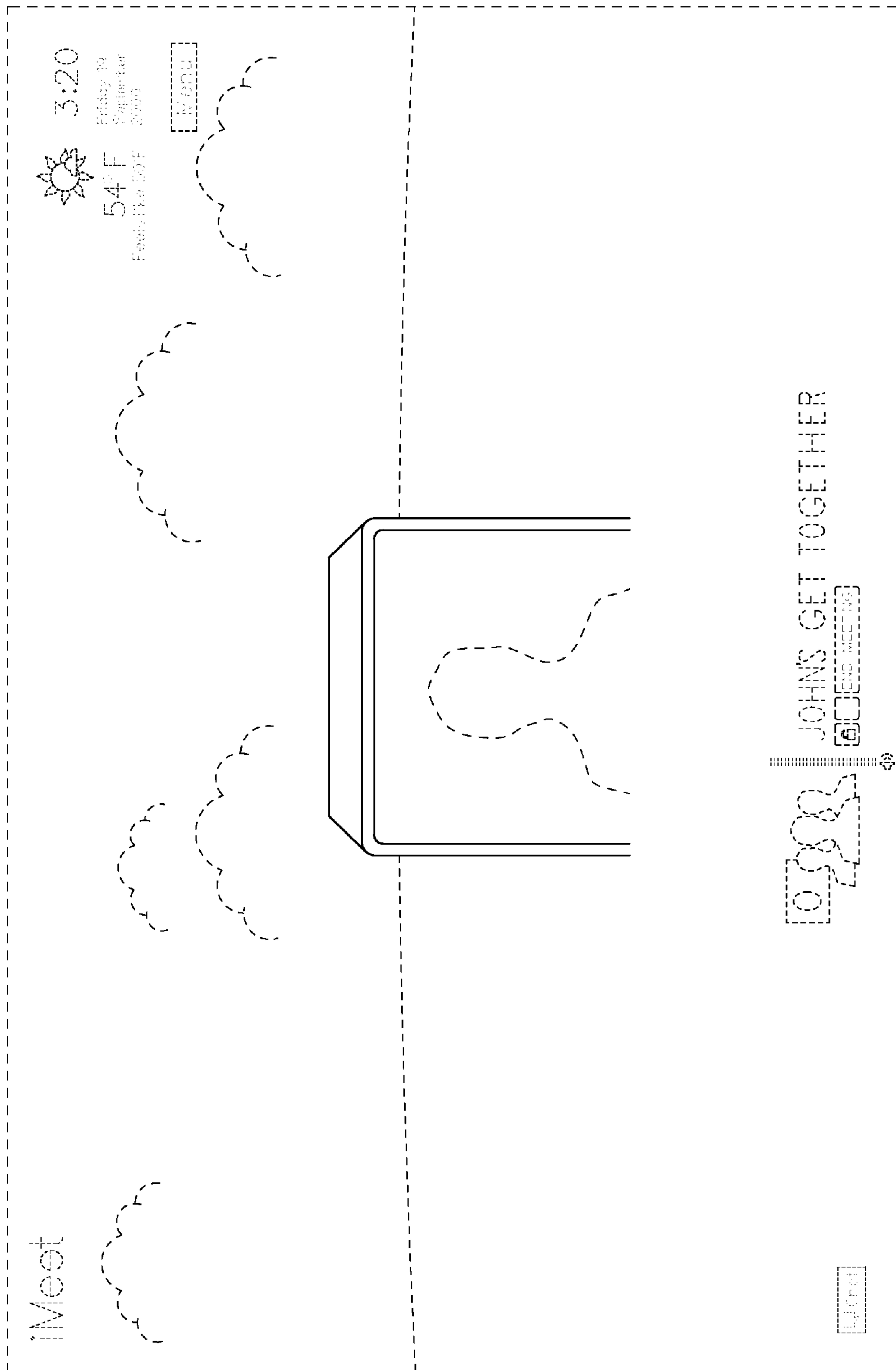

FIG. 7

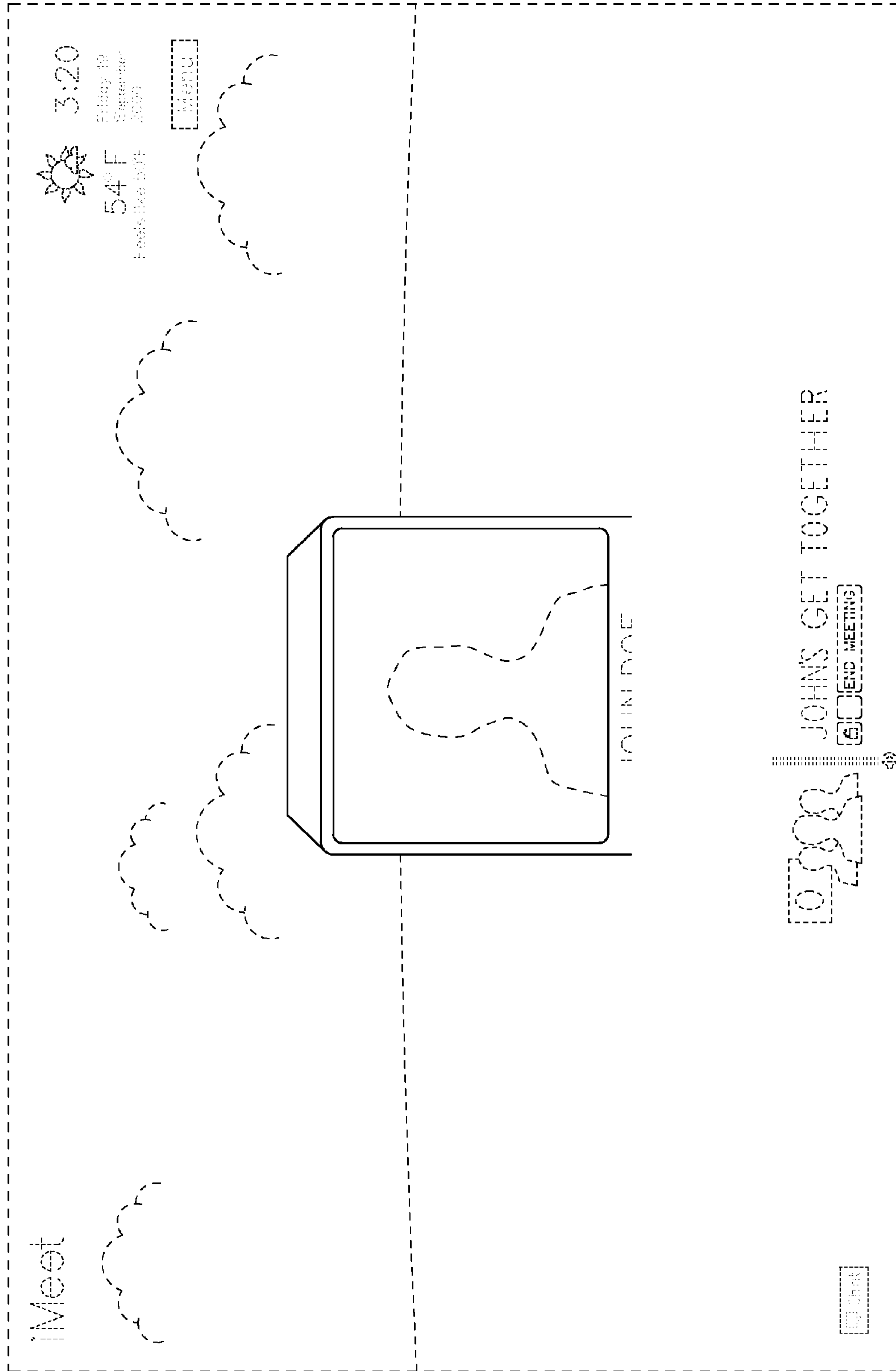

FIG. 8

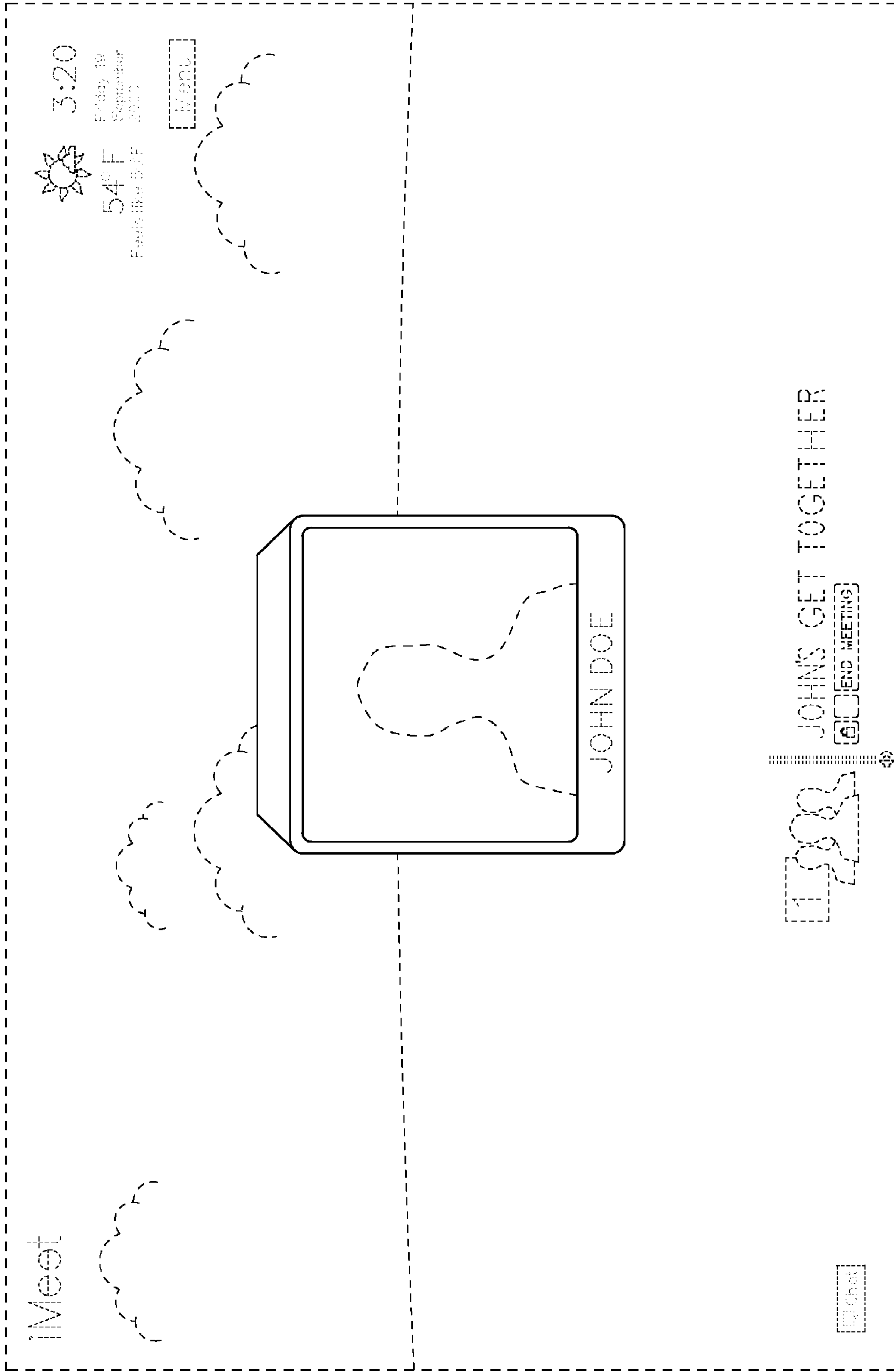

FIG. 9

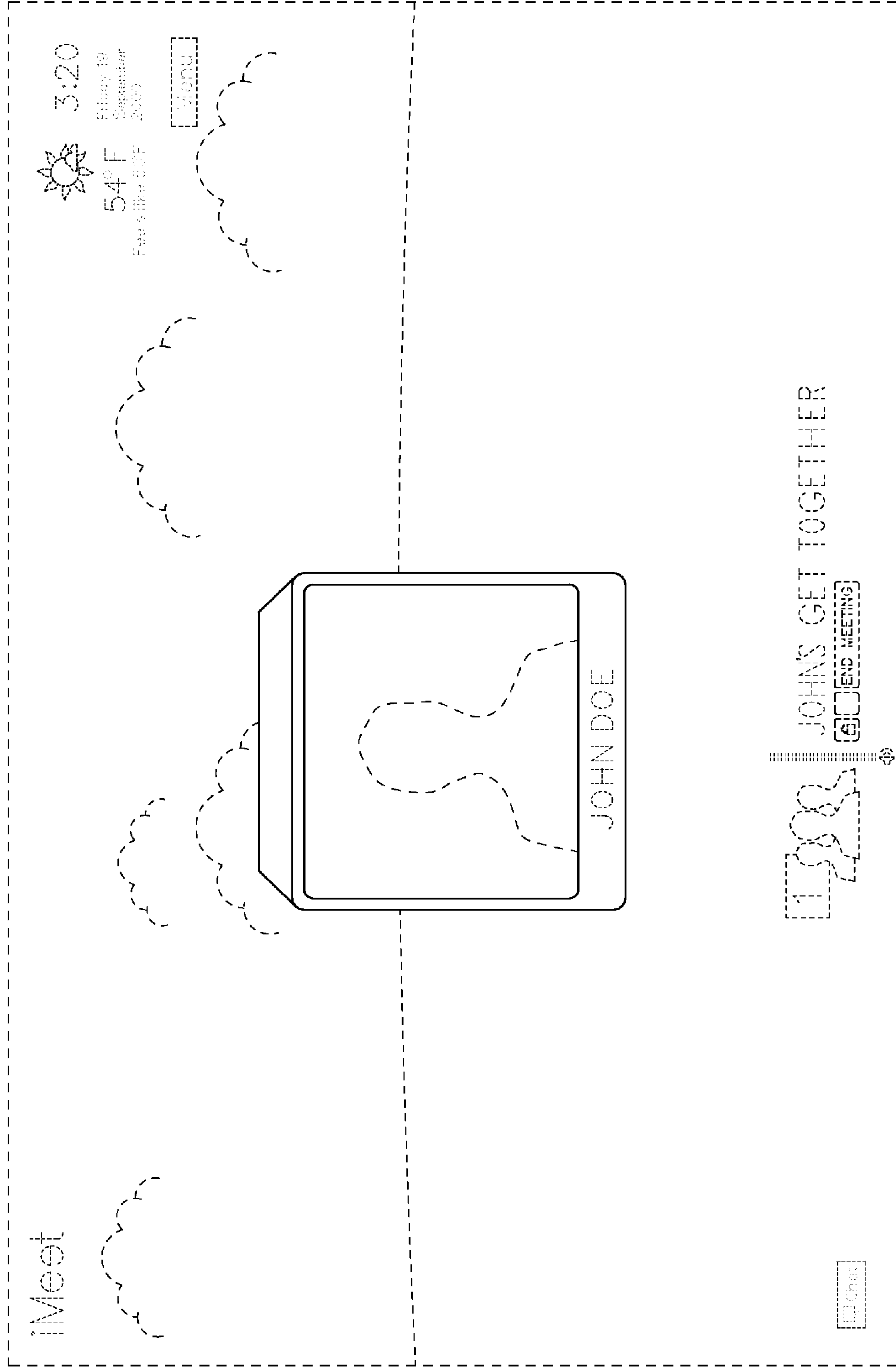

FIG. 10

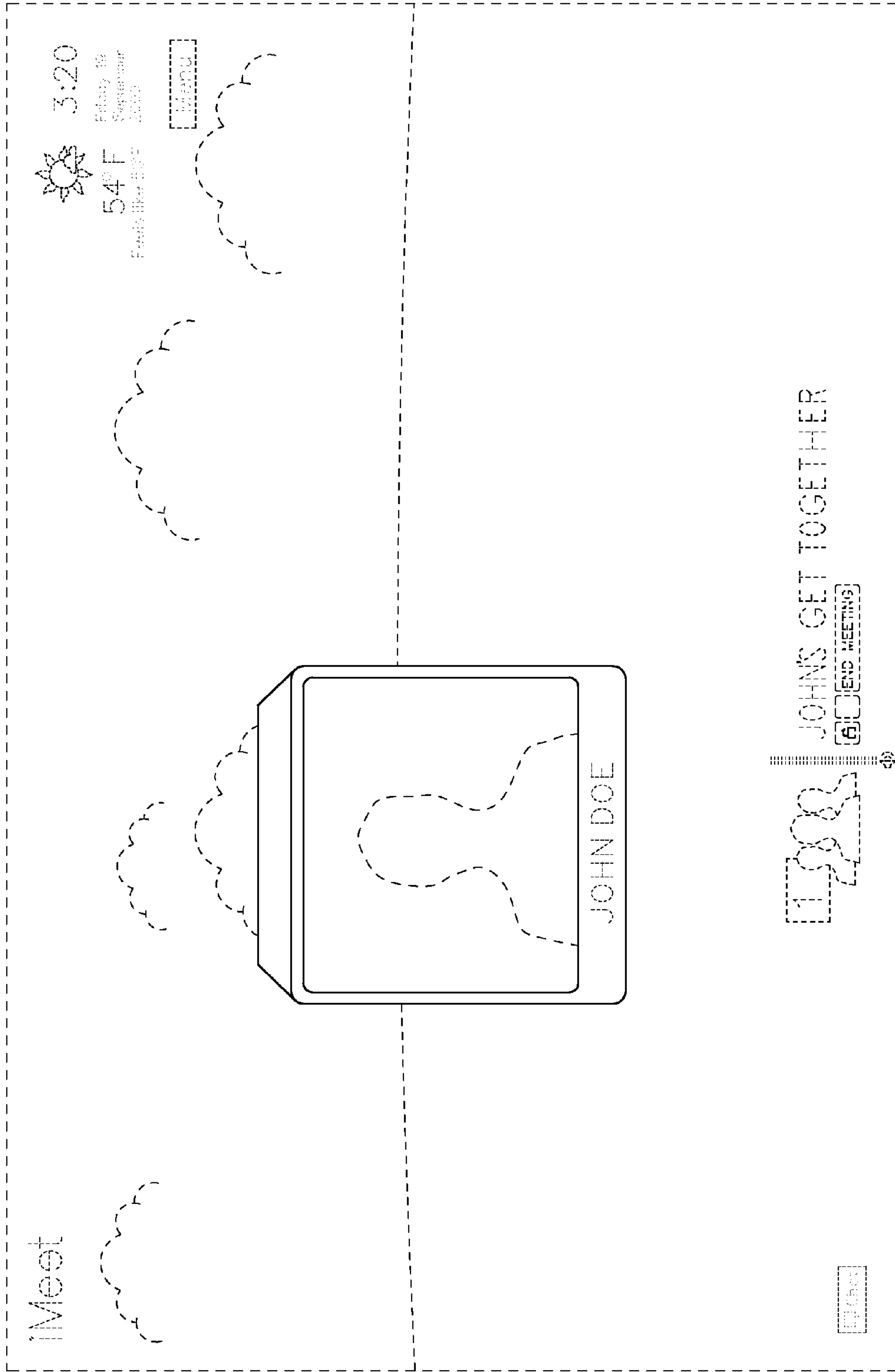

FIG. 11

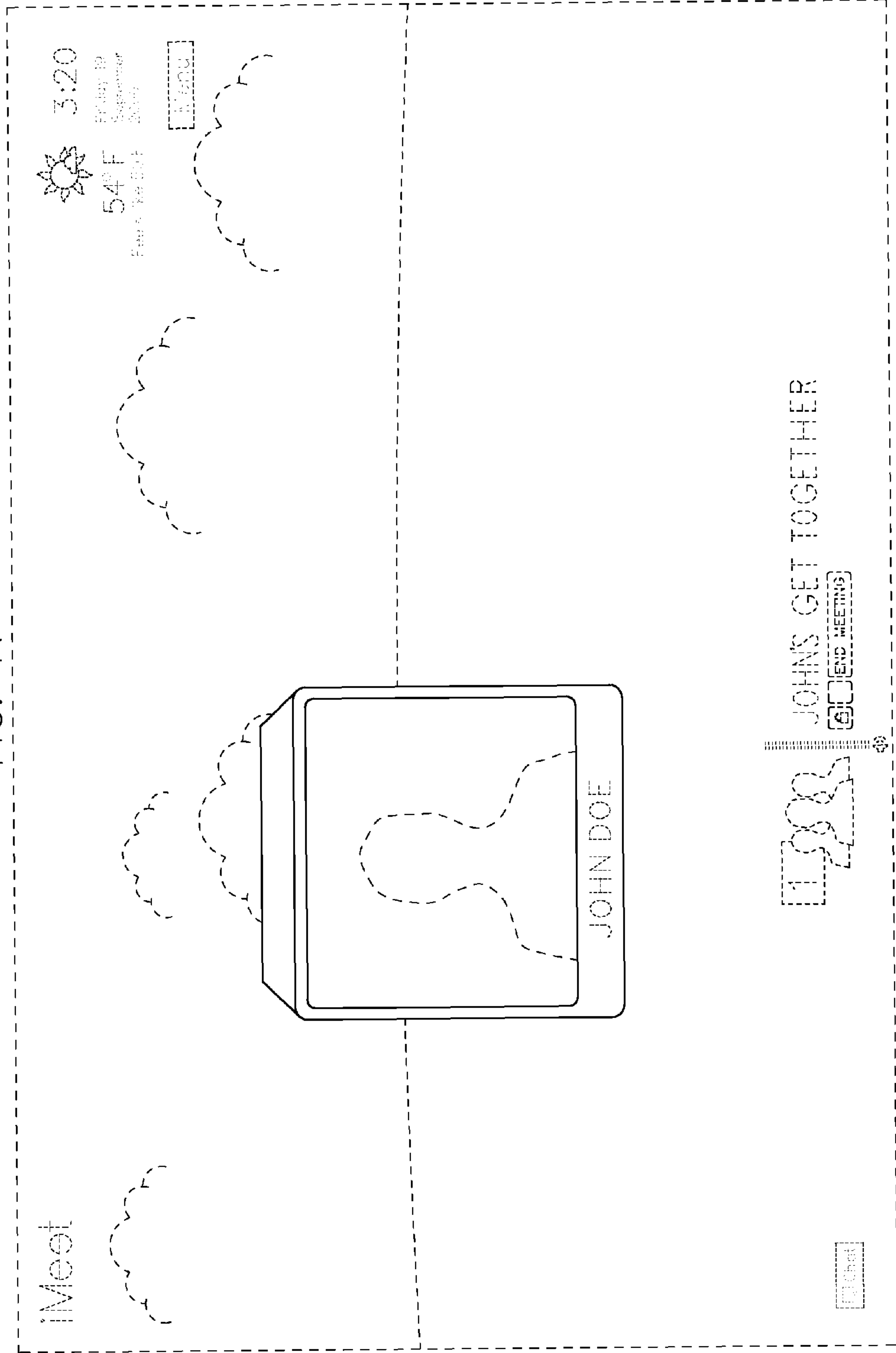

FIG. 12

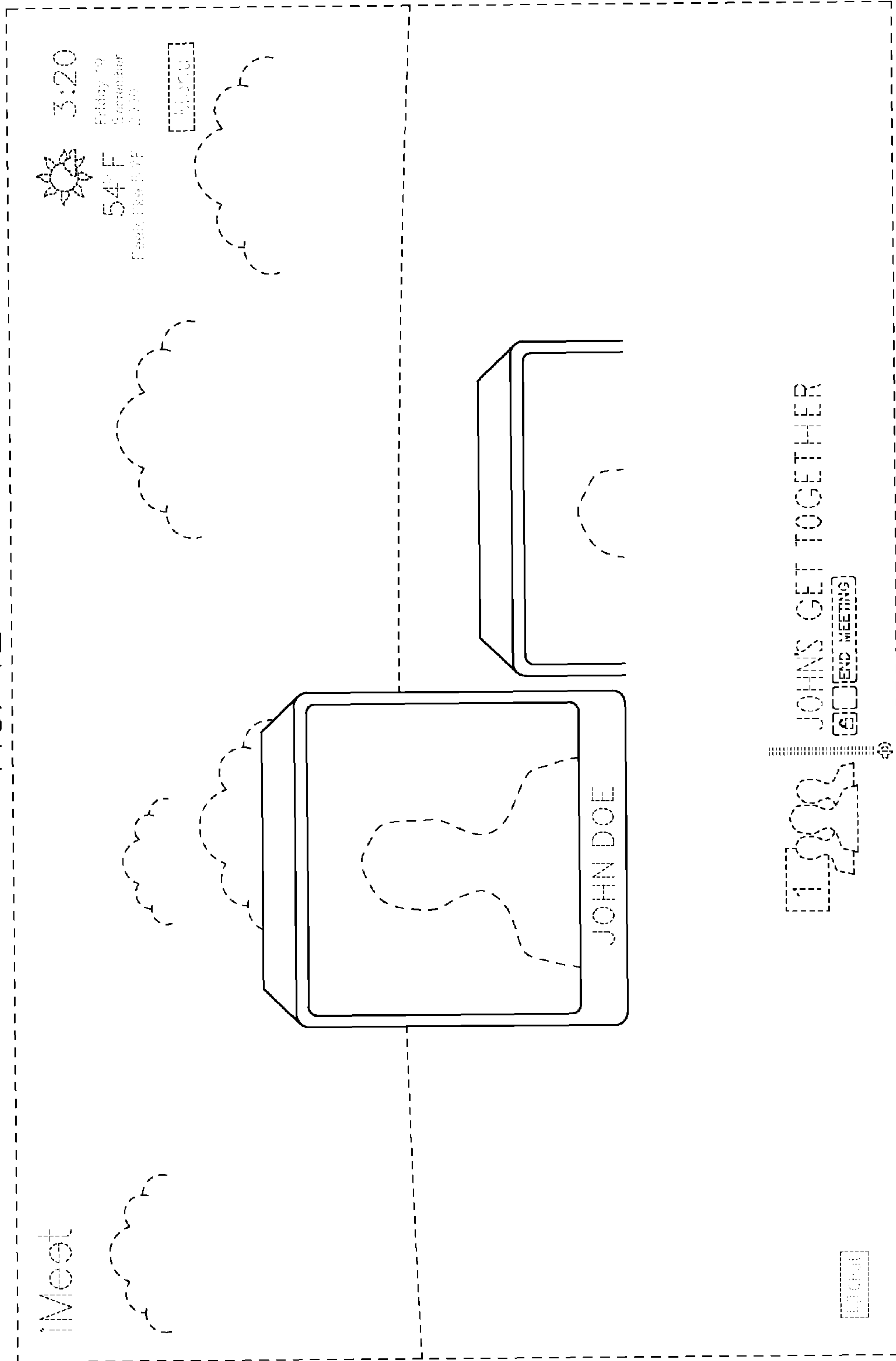

FIG. 13

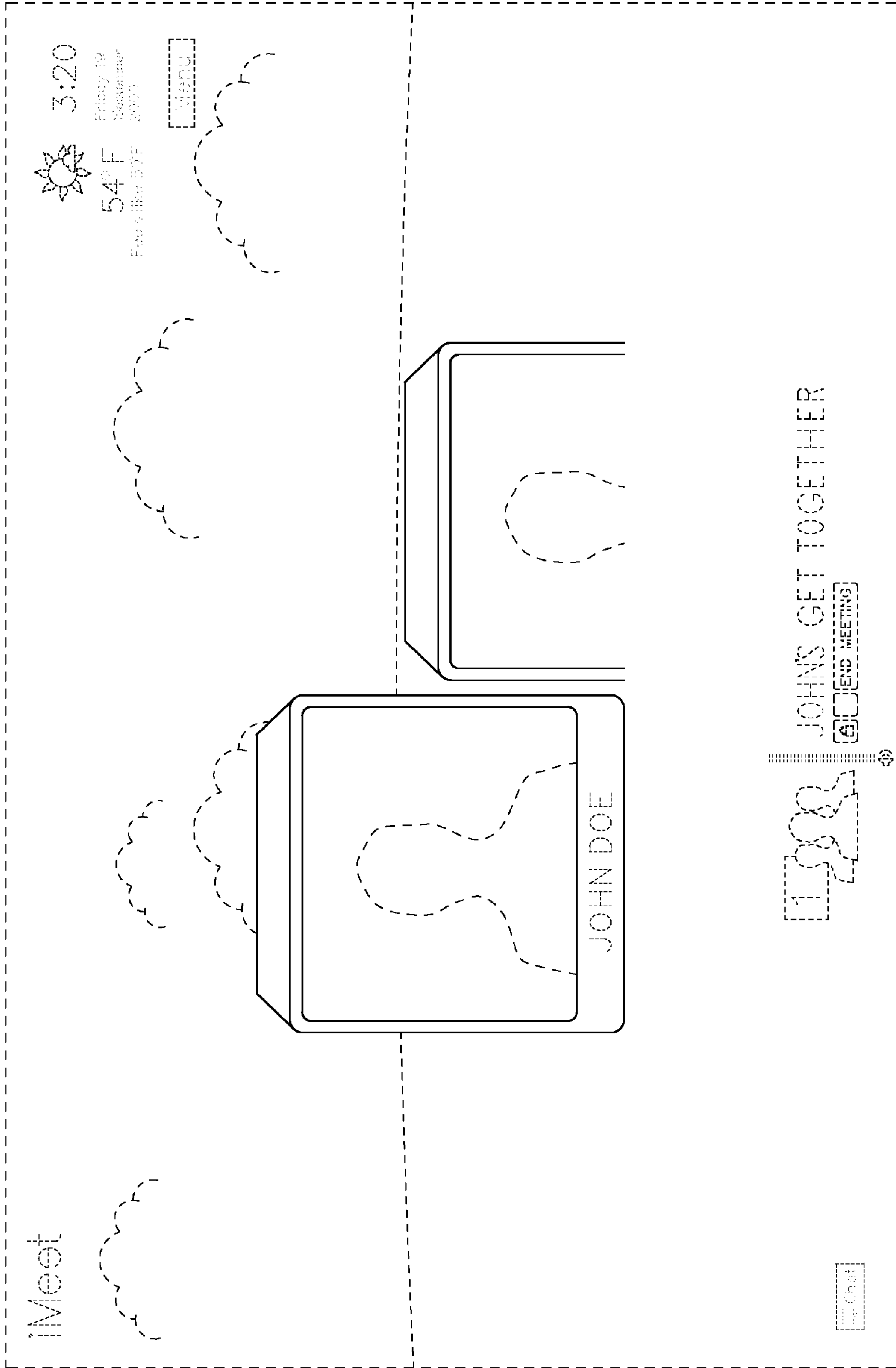

FIG. 14

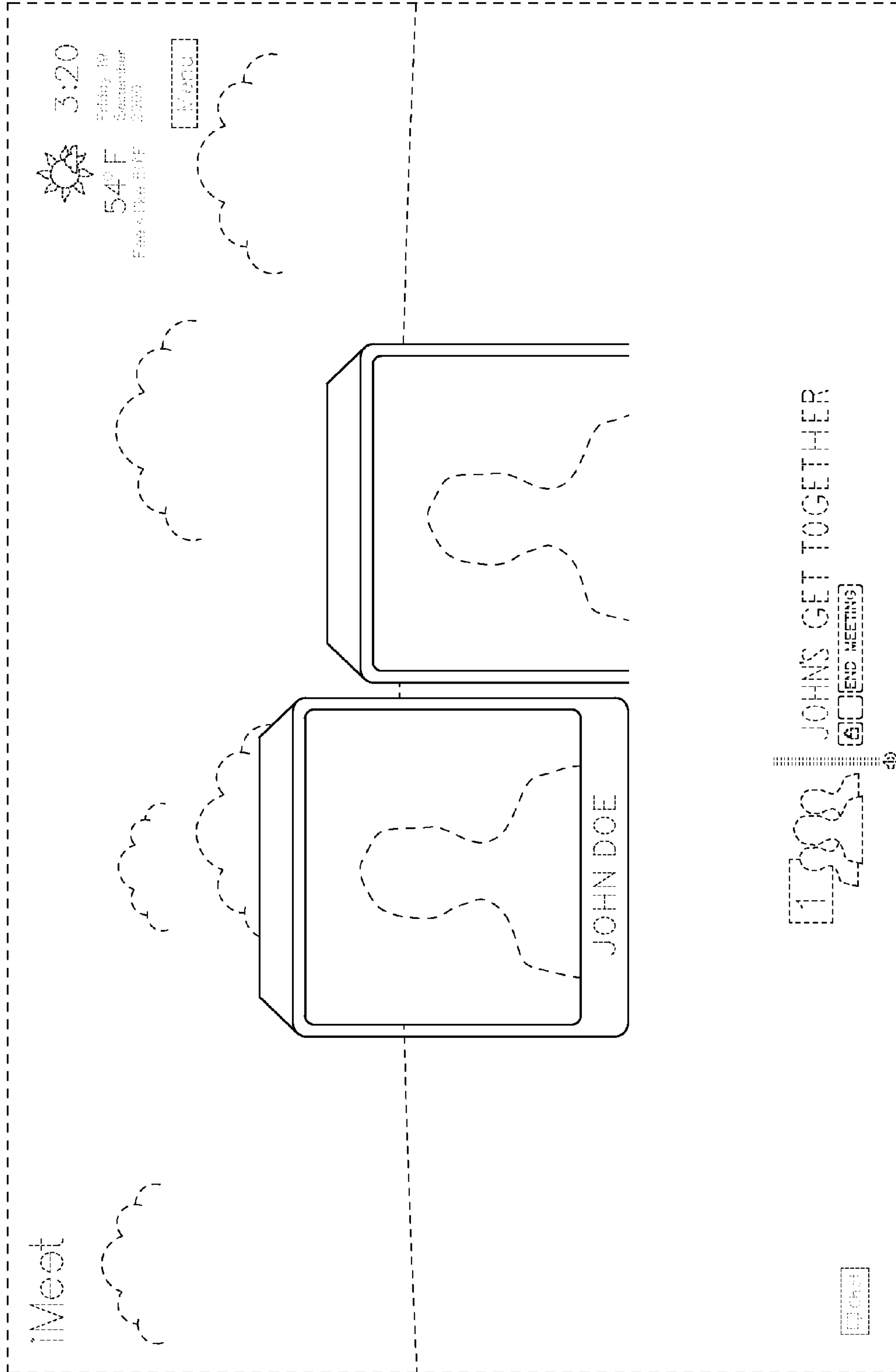

FIG. 15

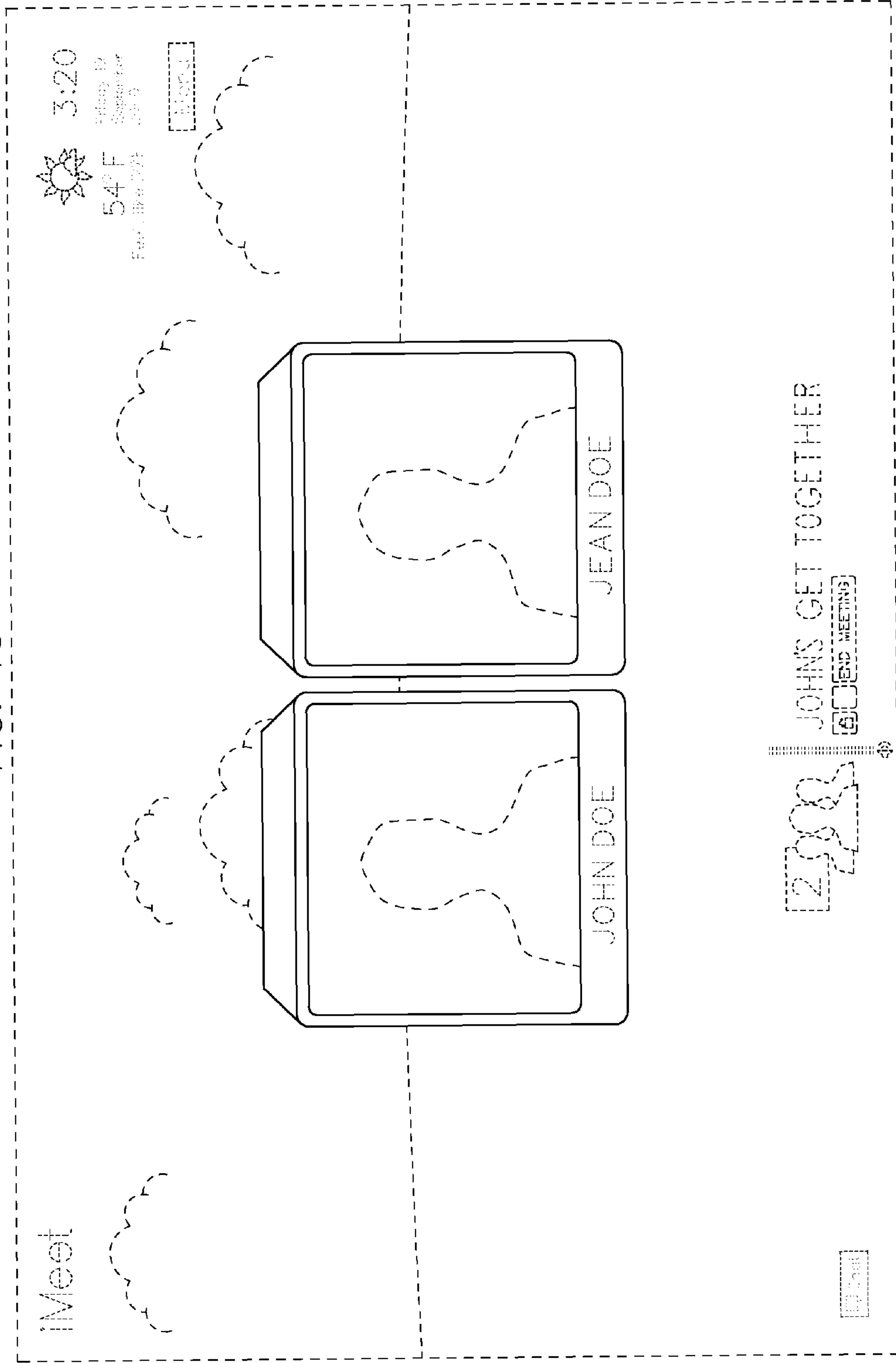

FIG. 16

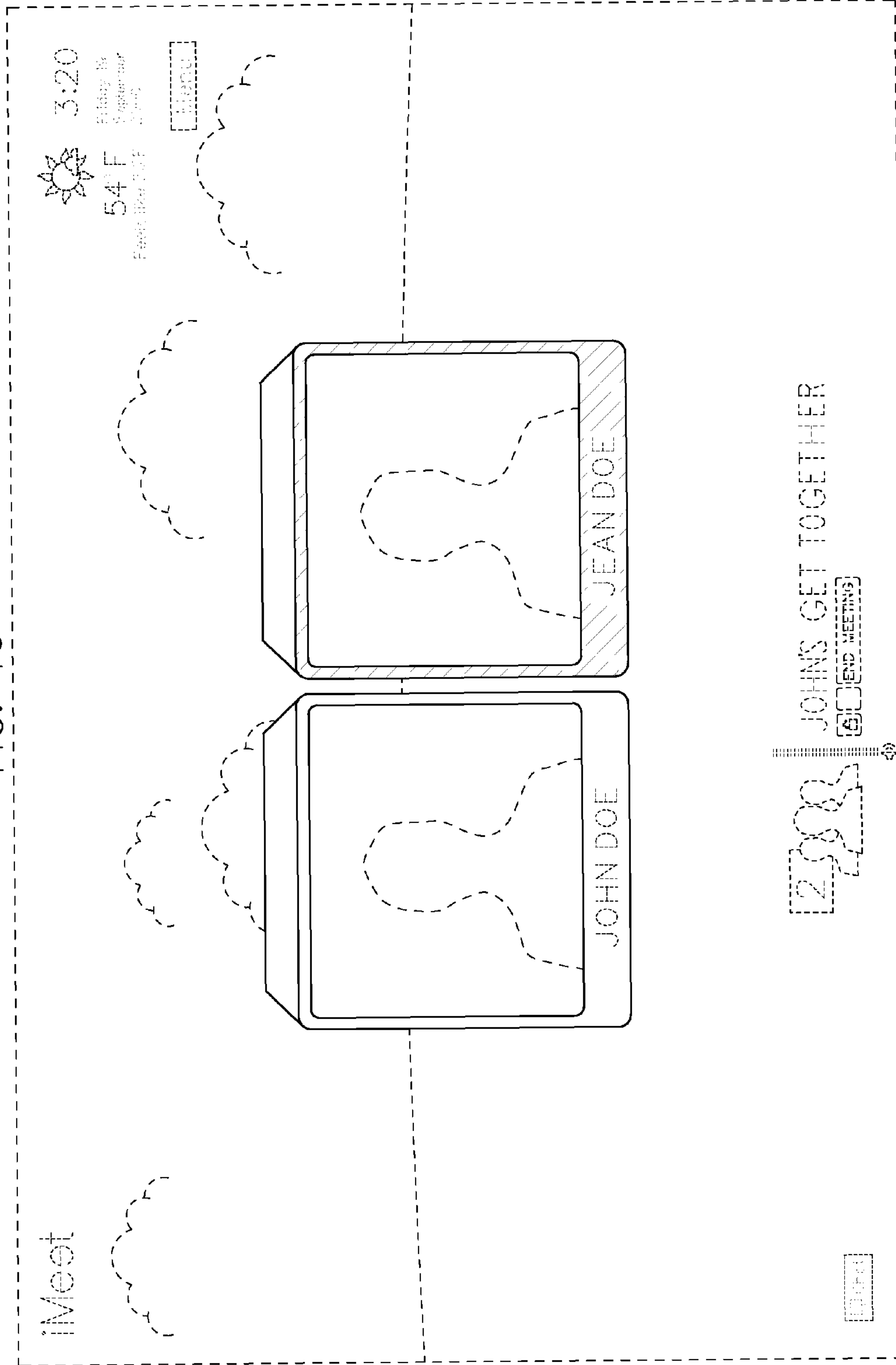

FIG. 17

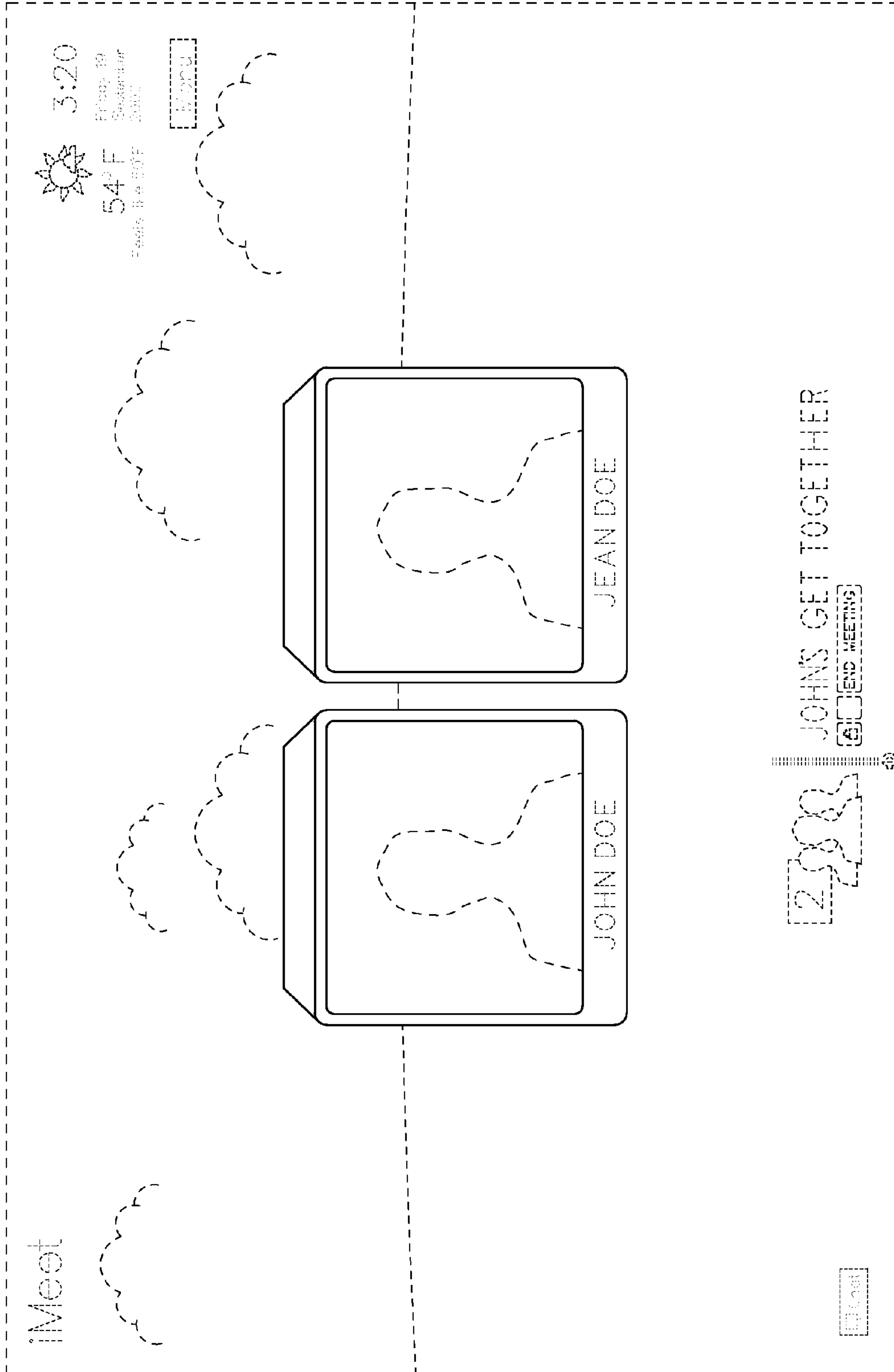

FIG. 18

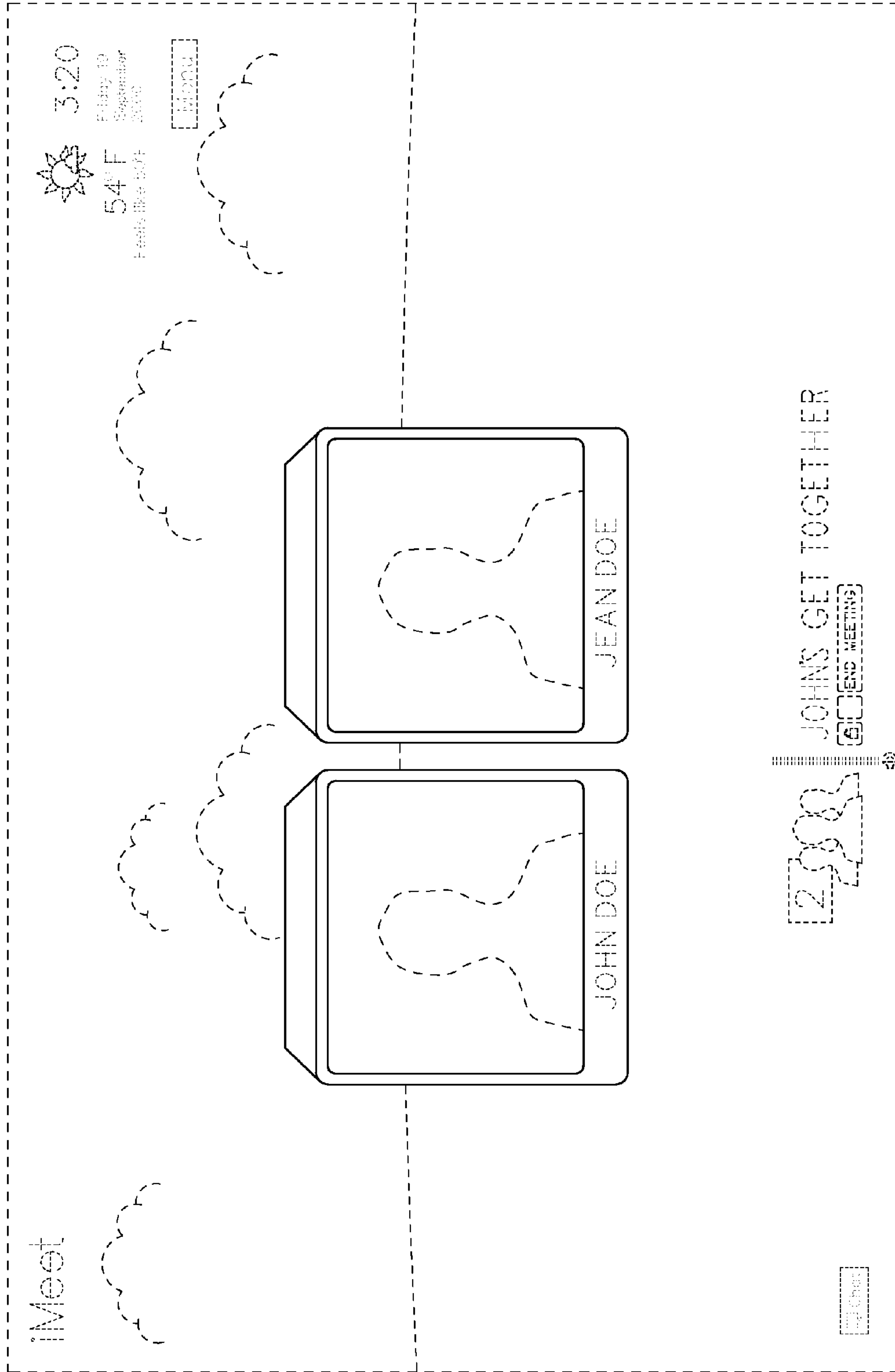

FIG. 19

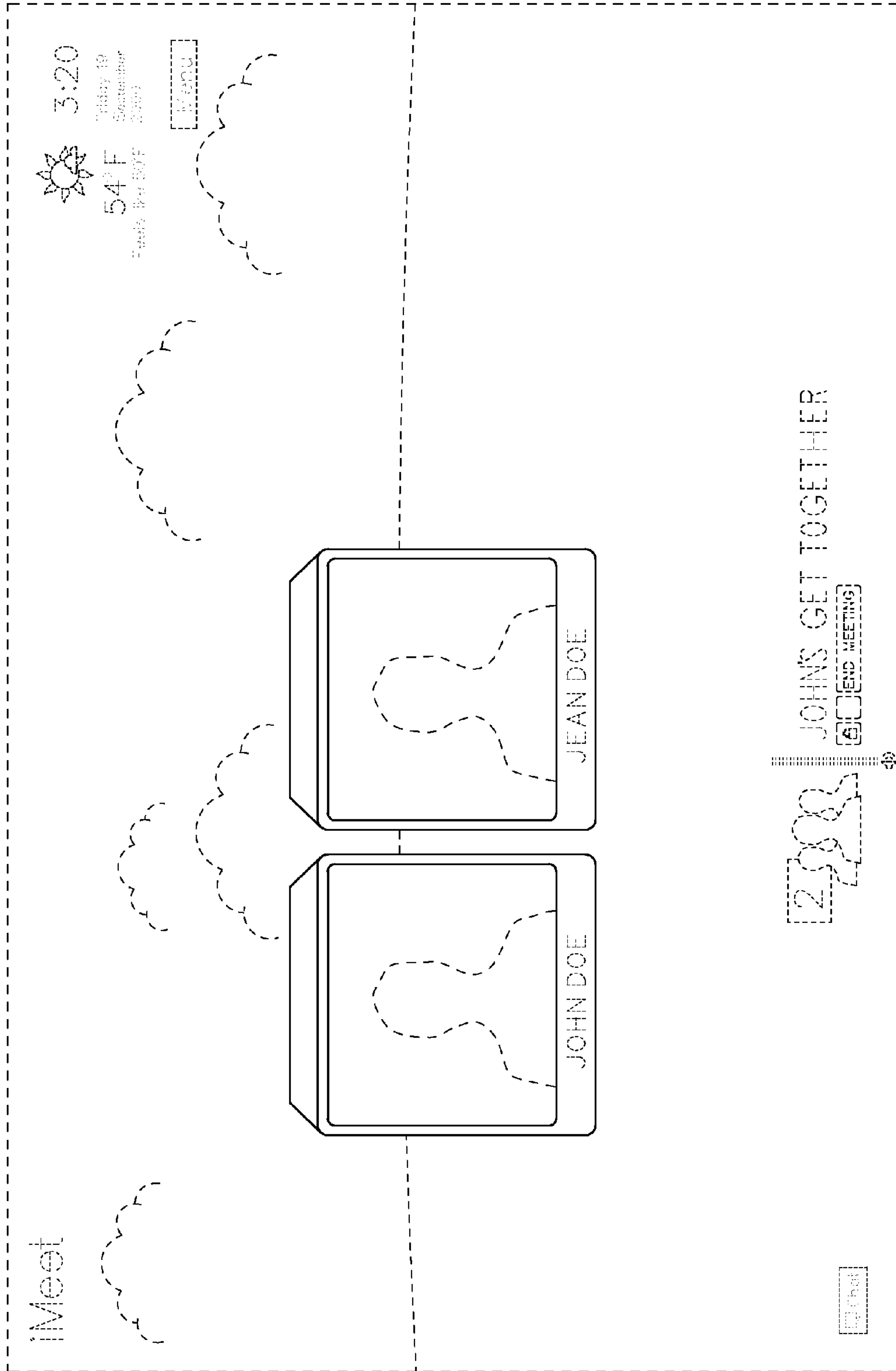

FIG. 20

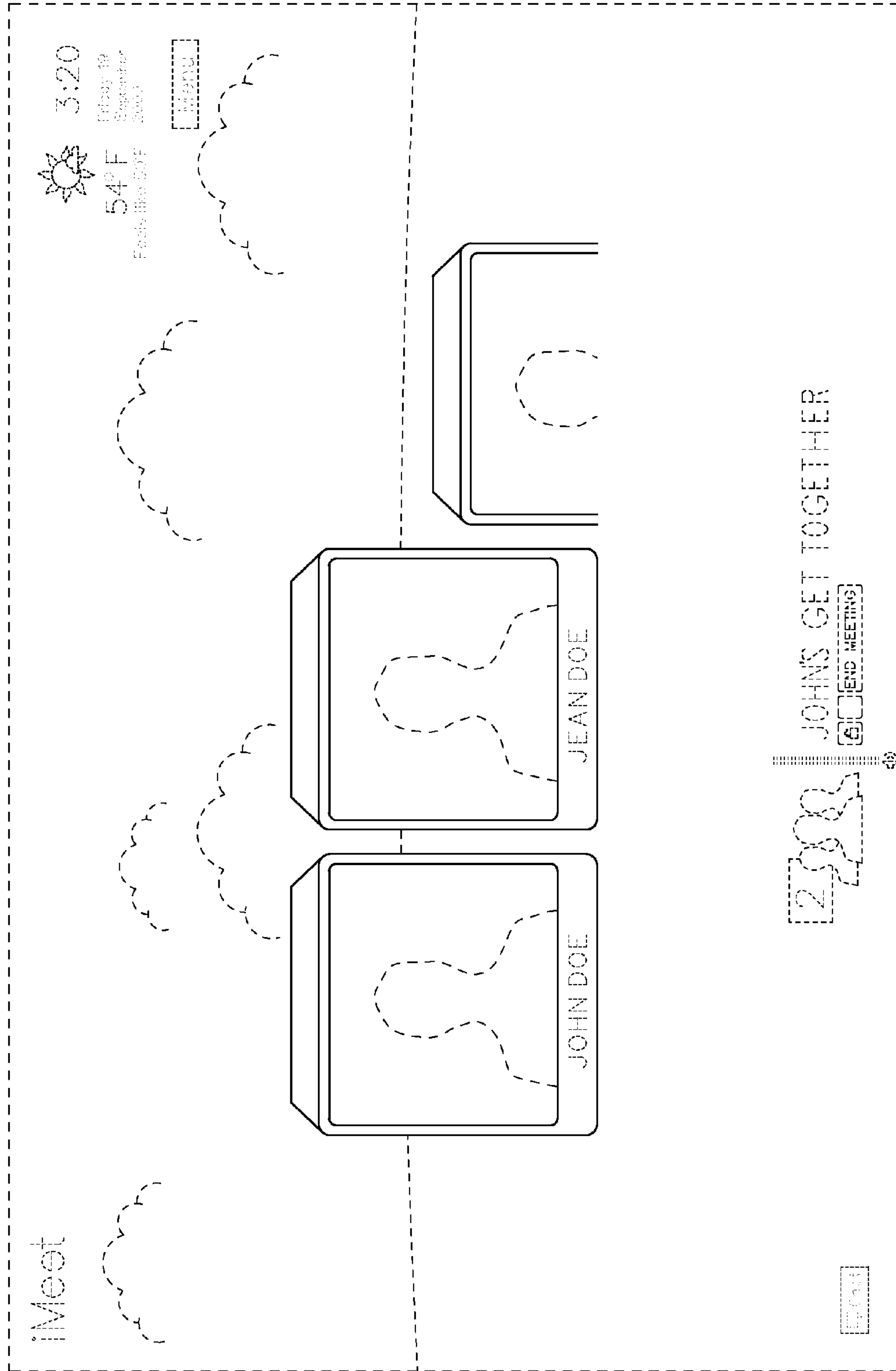

FIG. 21

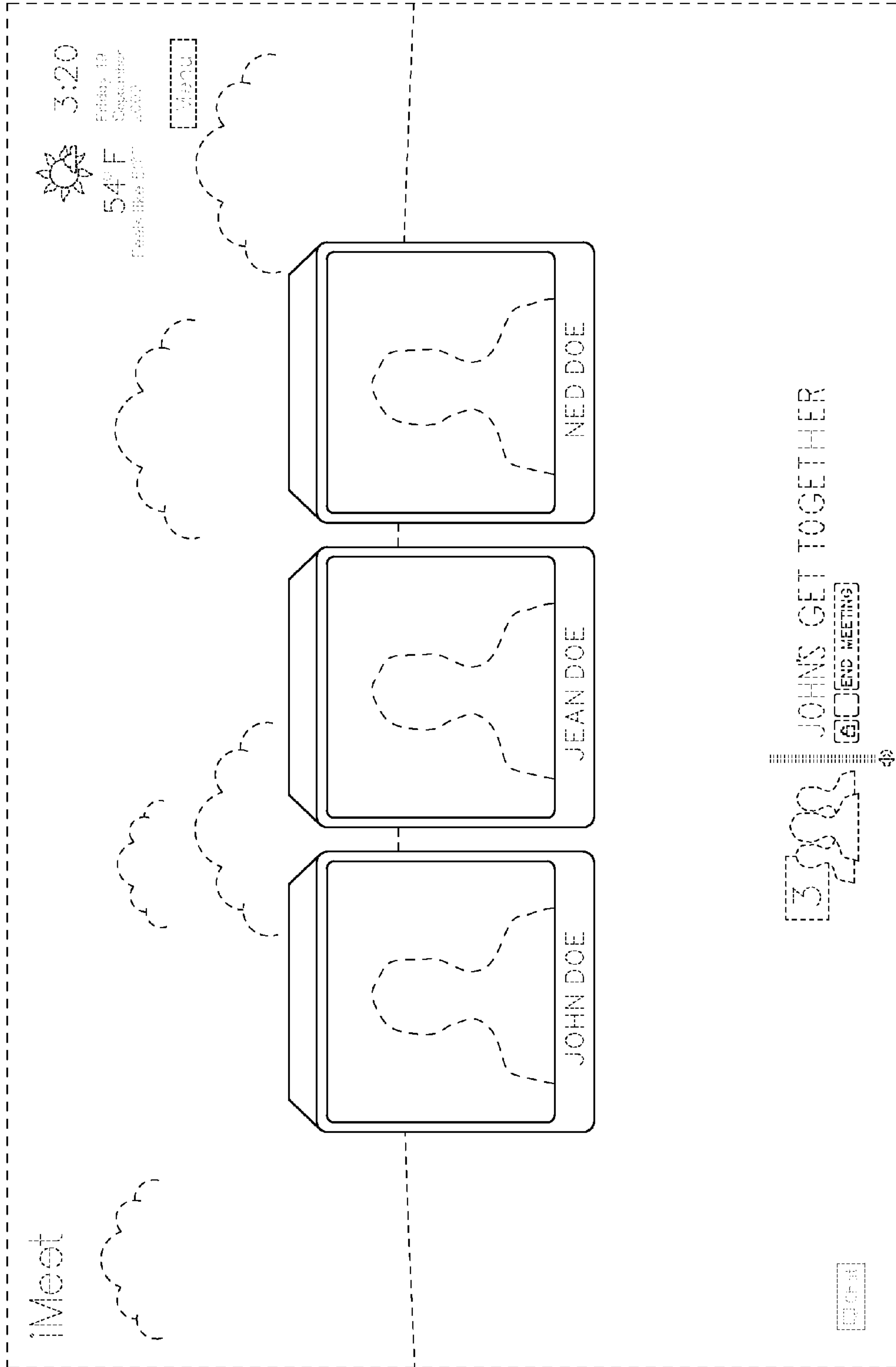

FIG. 22

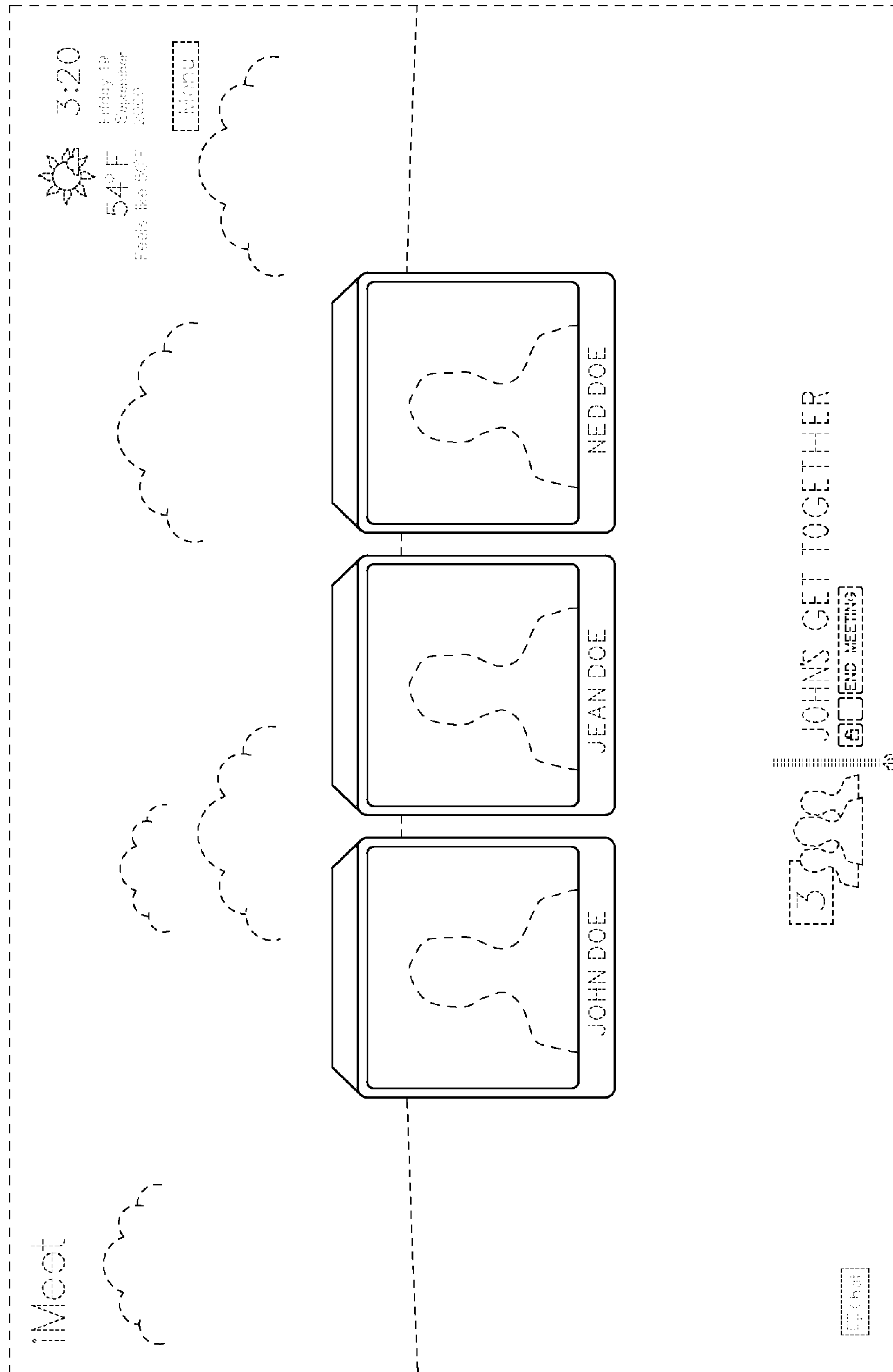

FIG. 23

