



US00D656498S

(12) **United States Design Patent**
Kujawski et al.

(10) **Patent No.:** **US D656,498 S**

(45) **Date of Patent:** **** Mar. 27, 2012**

(54) **ELECTRONIC MOUSE**

(75) Inventors: **Christopher Kujawski**, Seattle, WA
(US); **Katherine Bailey**, Seattle, WA
(US)

(73) Assignee: **Microsoft Corporation**, Redmond, WA
(US)

(**) Term: **14 Years**

(21) Appl. No.: **29/404,838**

(22) Filed: **Oct. 26, 2011**

(51) **LOC (9) Cl.** **14-02**

(52) **U.S. Cl.** **D14/402**

(58) **Field of Classification Search** D14/402-411,
D14/356, 388, 389, 383-385, 417, 426;
345/156-167; 463/36-38; 358/471, 473;
273/148 B

See application file for complete search history.

(56) **References Cited**

U.S. PATENT DOCUMENTS

5,157,381	A *	10/1992	Cheng	345/163
6,011,543	A *	1/2000	Tian	345/163
D435,555	S *	12/2000	Swansey	D14/402
D519,507	S *	4/2006	Sheehan et al.	D14/402
D580,938	S *	11/2008	Simonian et al.	D14/402
D581,416	S *	11/2008	Simonian et al.	D14/402
D629,804	S *	12/2010	Hoehn et al.	D14/408
D642,574	S *	8/2011	Kim et al.	D14/410
D642,575	S *	8/2011	Kim et al.	D14/410
D642,576	S *	8/2011	Kim et al.	D14/410

* cited by examiner

Primary Examiner — Austin Murphy

(74) *Attorney, Agent, or Firm* — Banner & Witcoff, Ltd.

(57) **CLAIM**

The ornamental design for an electronic mouse, as shown and described.

DESCRIPTION

FIG. 1 is a top perspective view of an electronic mouse showing the new design;
 FIG. 2 is a top view thereof;
 FIG. 3 is a left side view thereof;
 FIG. 4 is a right side view thereof;
 FIG. 5 is a rear view thereof;
 FIG. 6 is a front view thereof;
 FIG. 7 is a bottom view thereof;
 FIG. 8 is a top perspective view of the electronic mouse of FIGS. 1-7 shown without shading or disclaimed features;
 FIG. 9 is a top view thereof;
 FIG. 10 is a left side view thereof;
 FIG. 11 is a right side view thereof;
 FIG. 12 is a rear view thereof;
 FIG. 13 is a front view thereof; and,
 FIG. 14 is a bottom view thereof.

The broken-line showing of the oblong regions in FIGS. 3-7 is for environmental purposes only and forms no part of the claimed design.

1 Claim, 10 Drawing Sheets

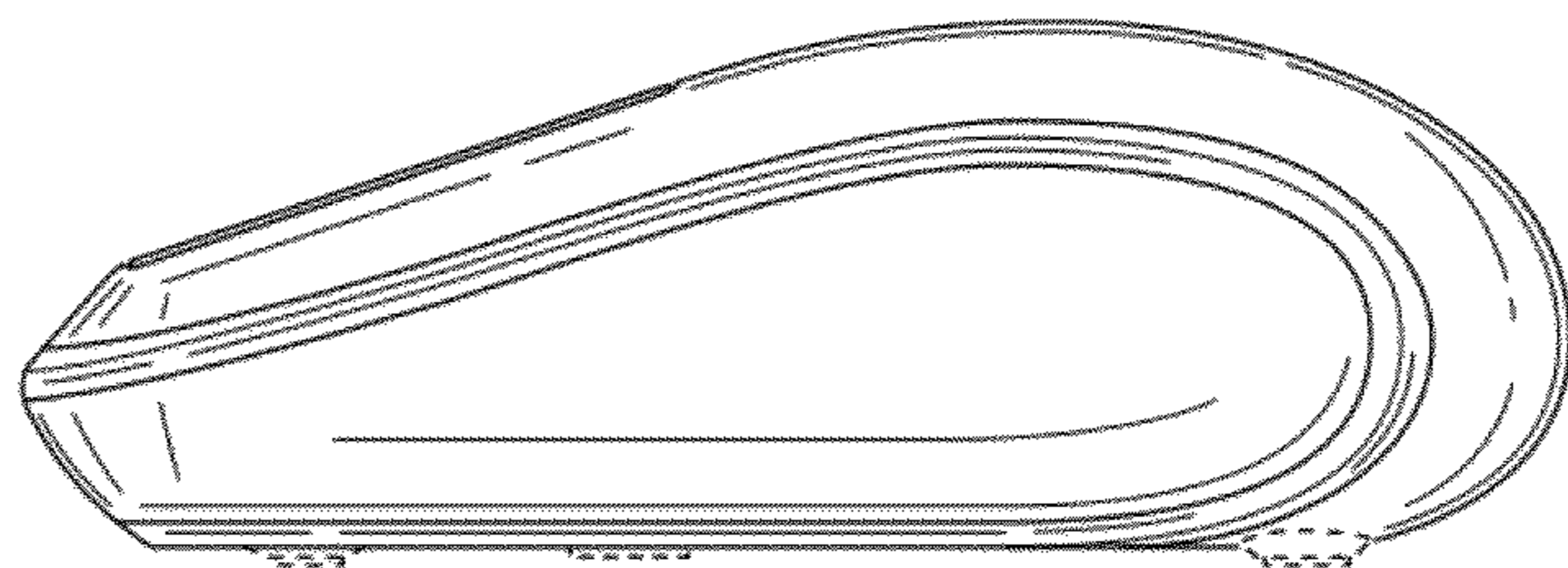
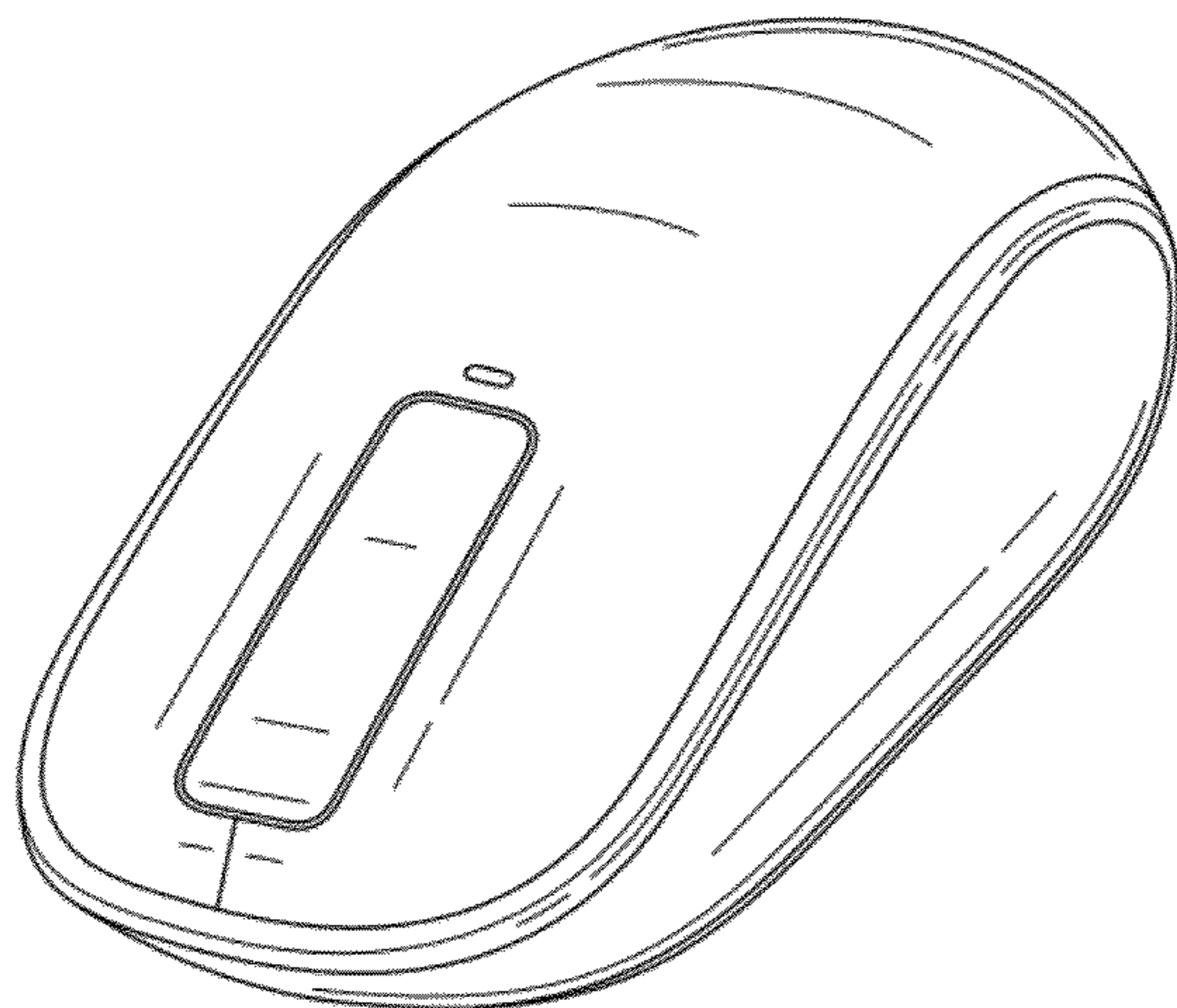



FIG. 1

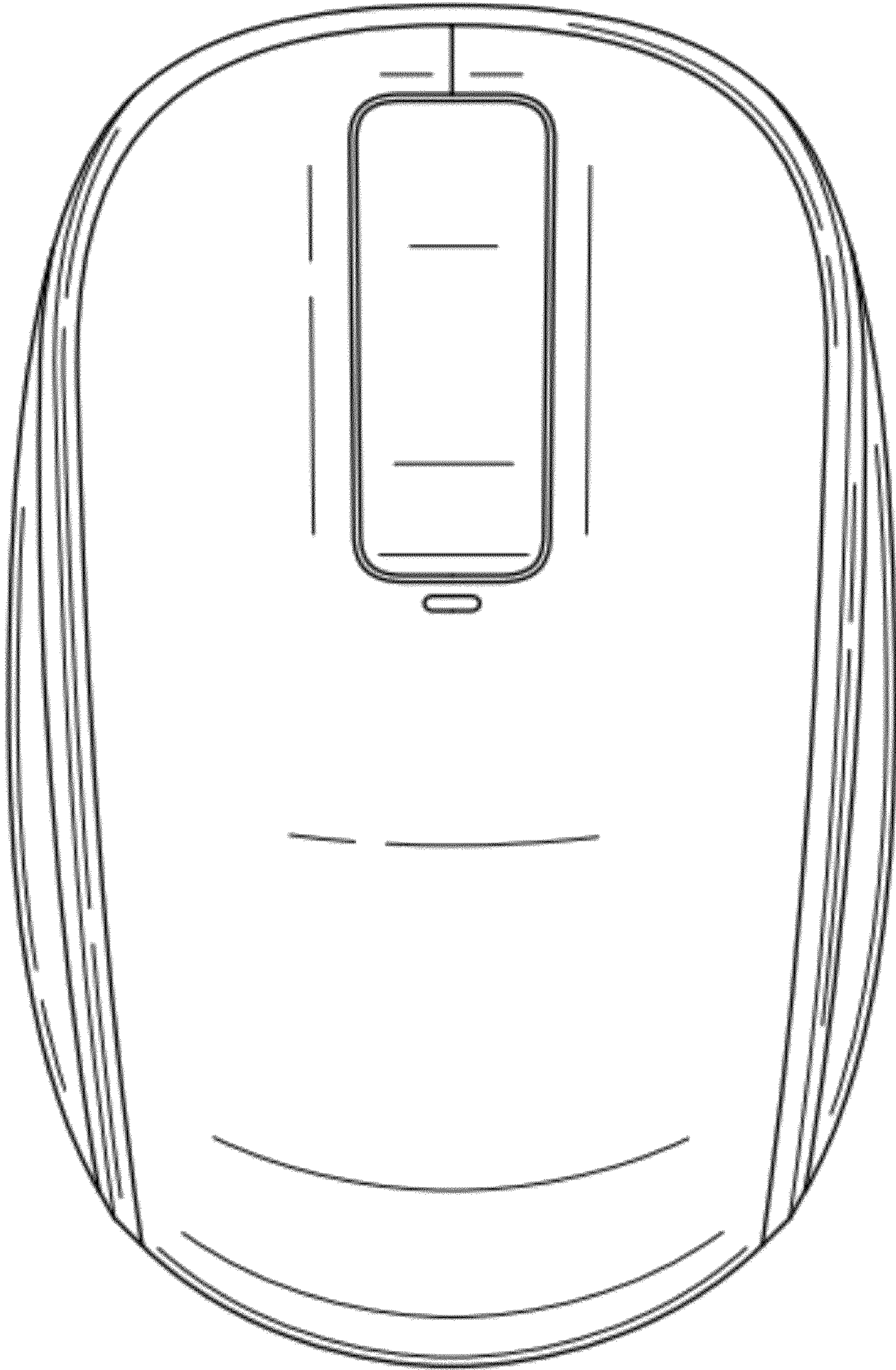

FIG. 2

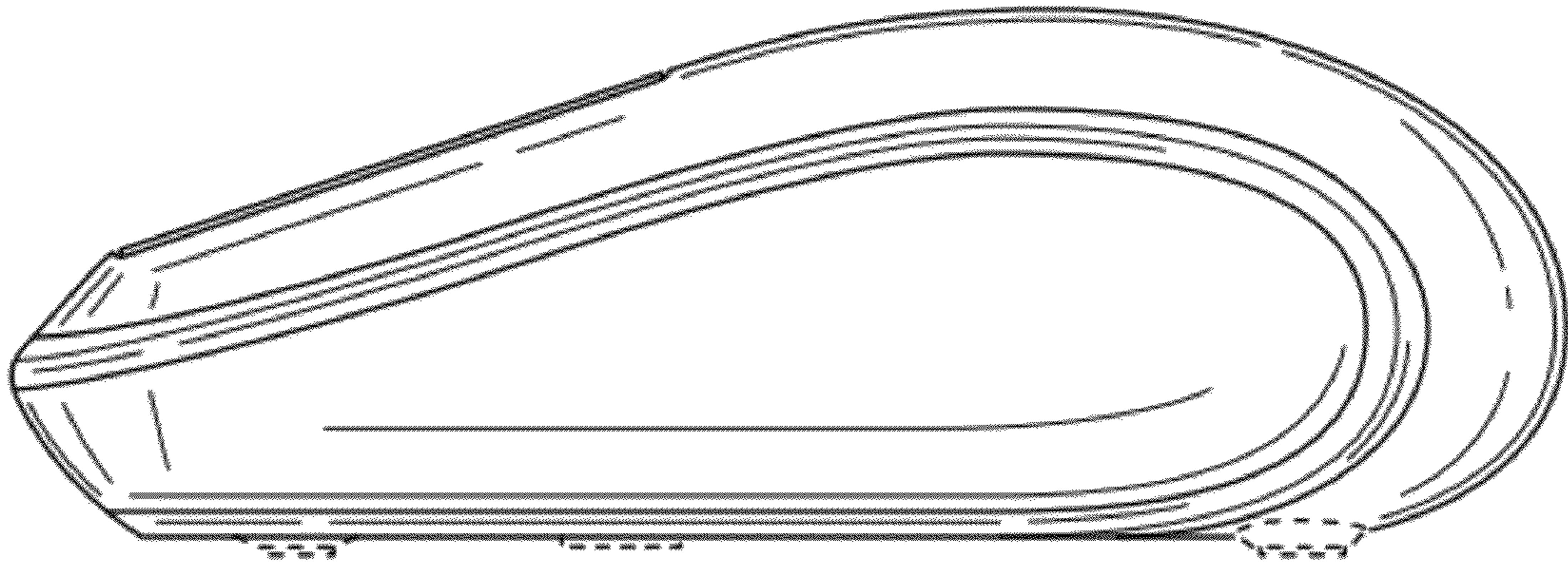

FIG. 3

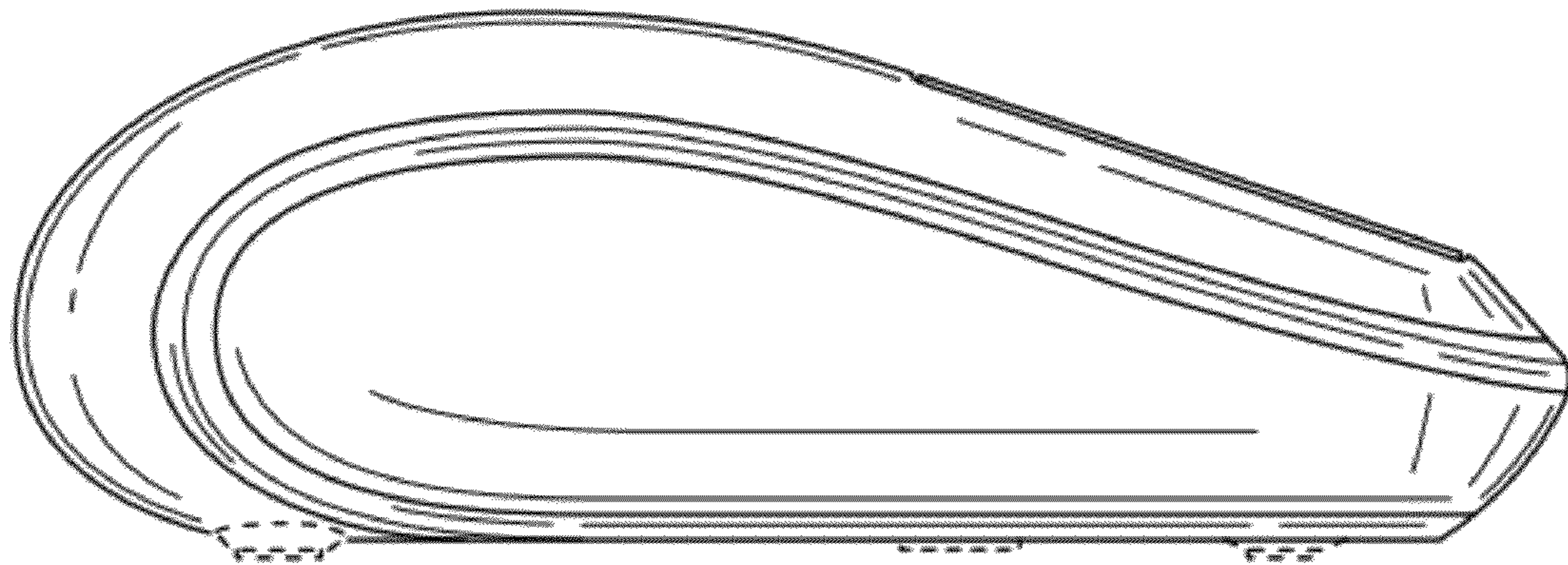

FIG. 4

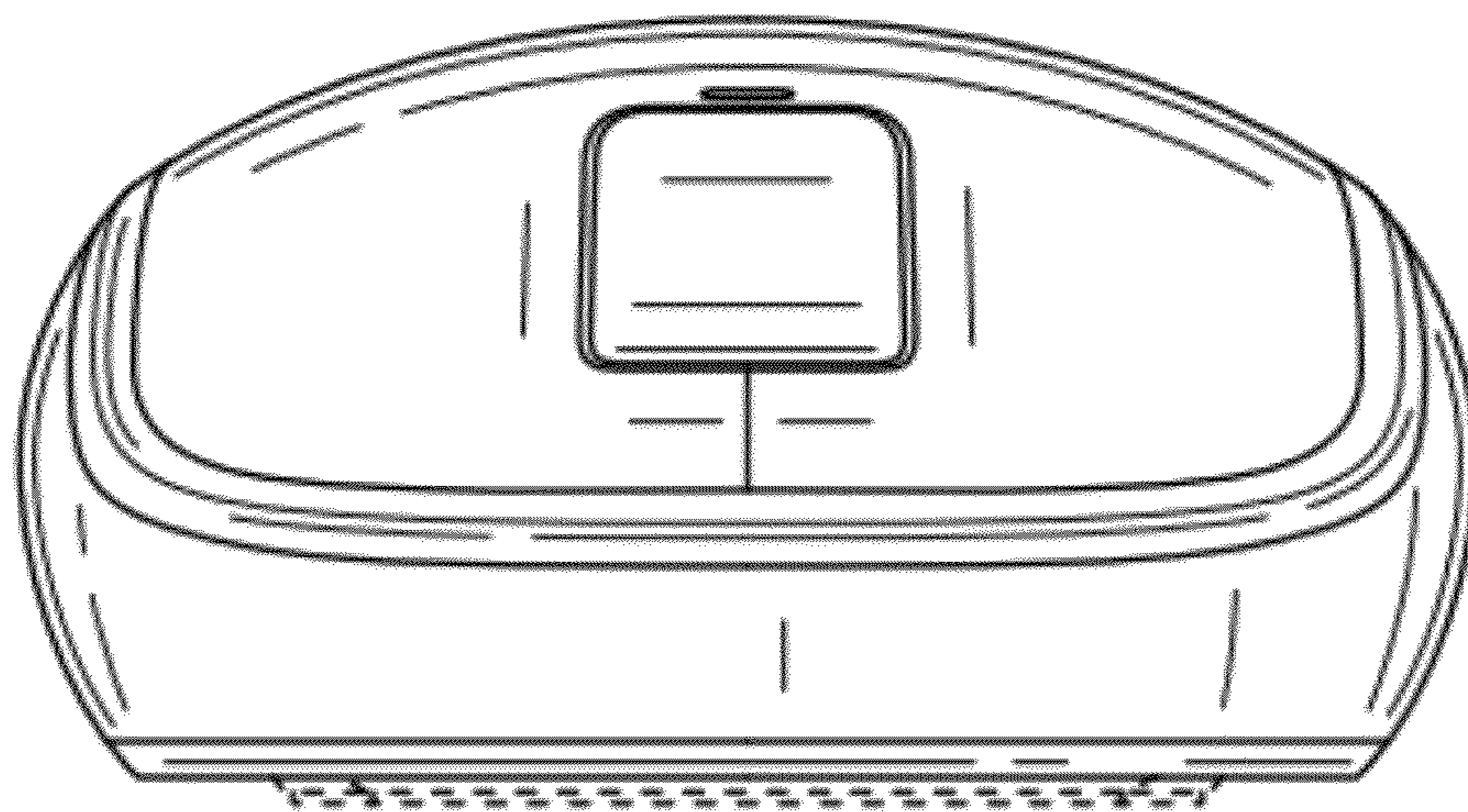

FIG. 5

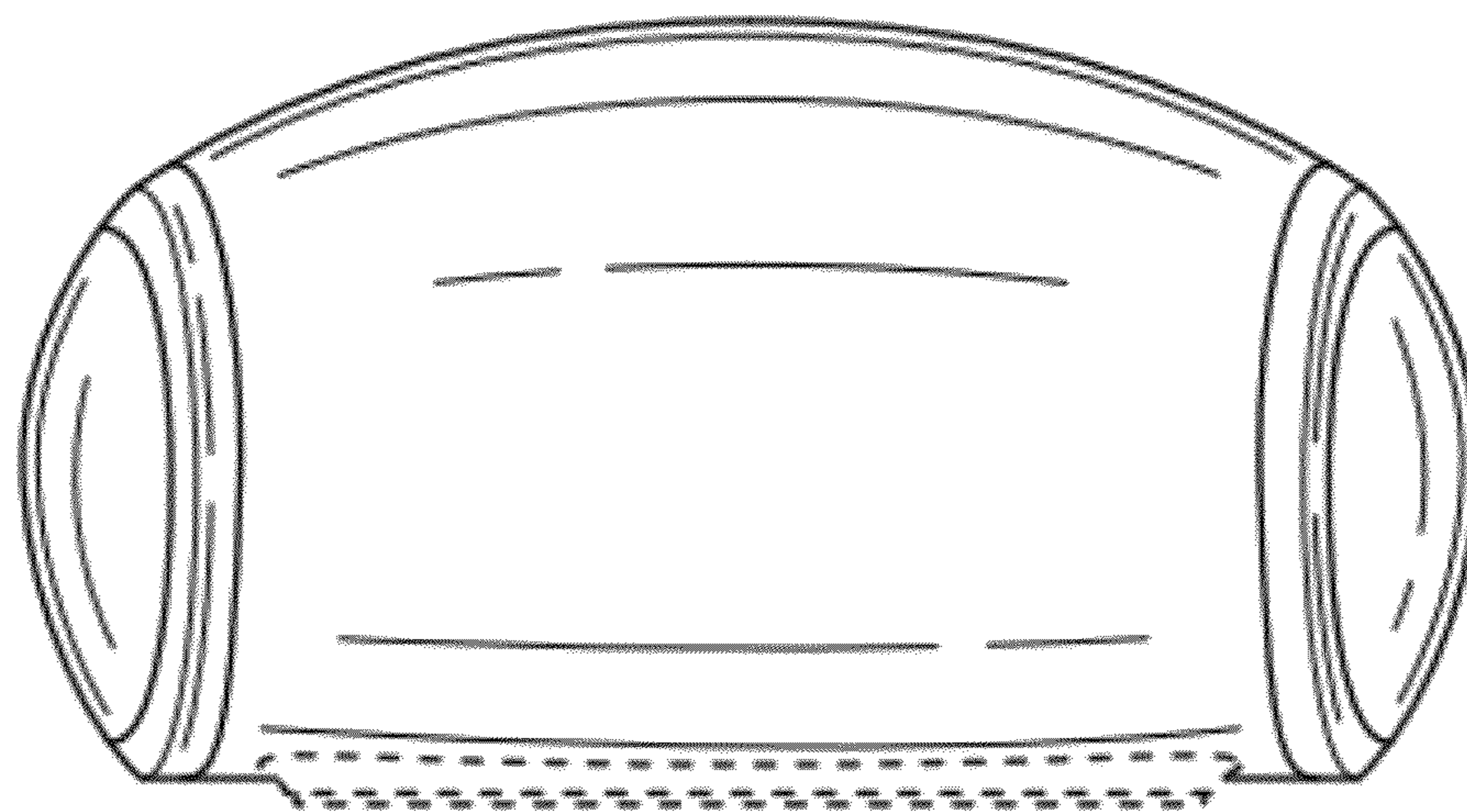

FIG. 6

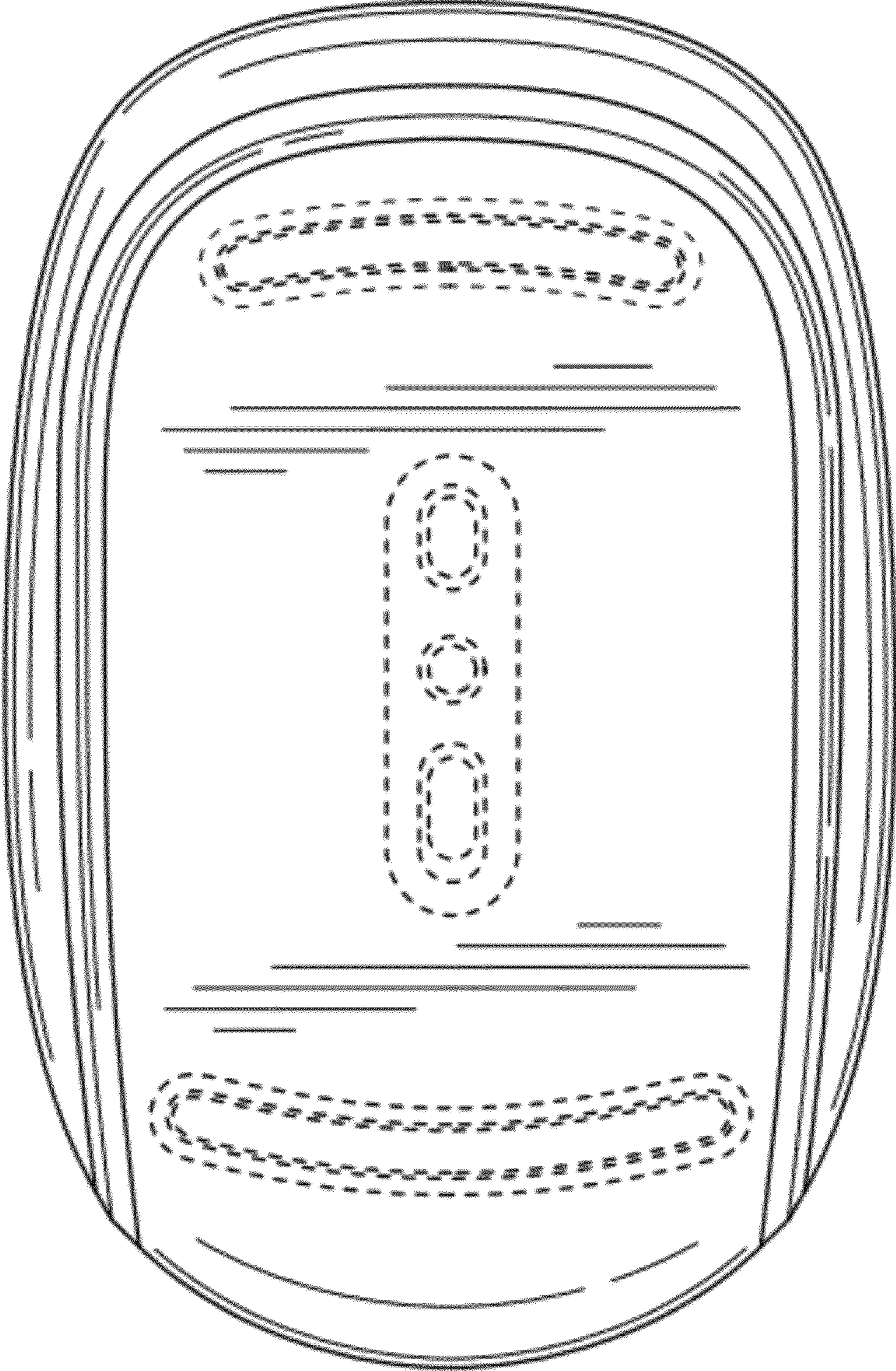

FIG. 7

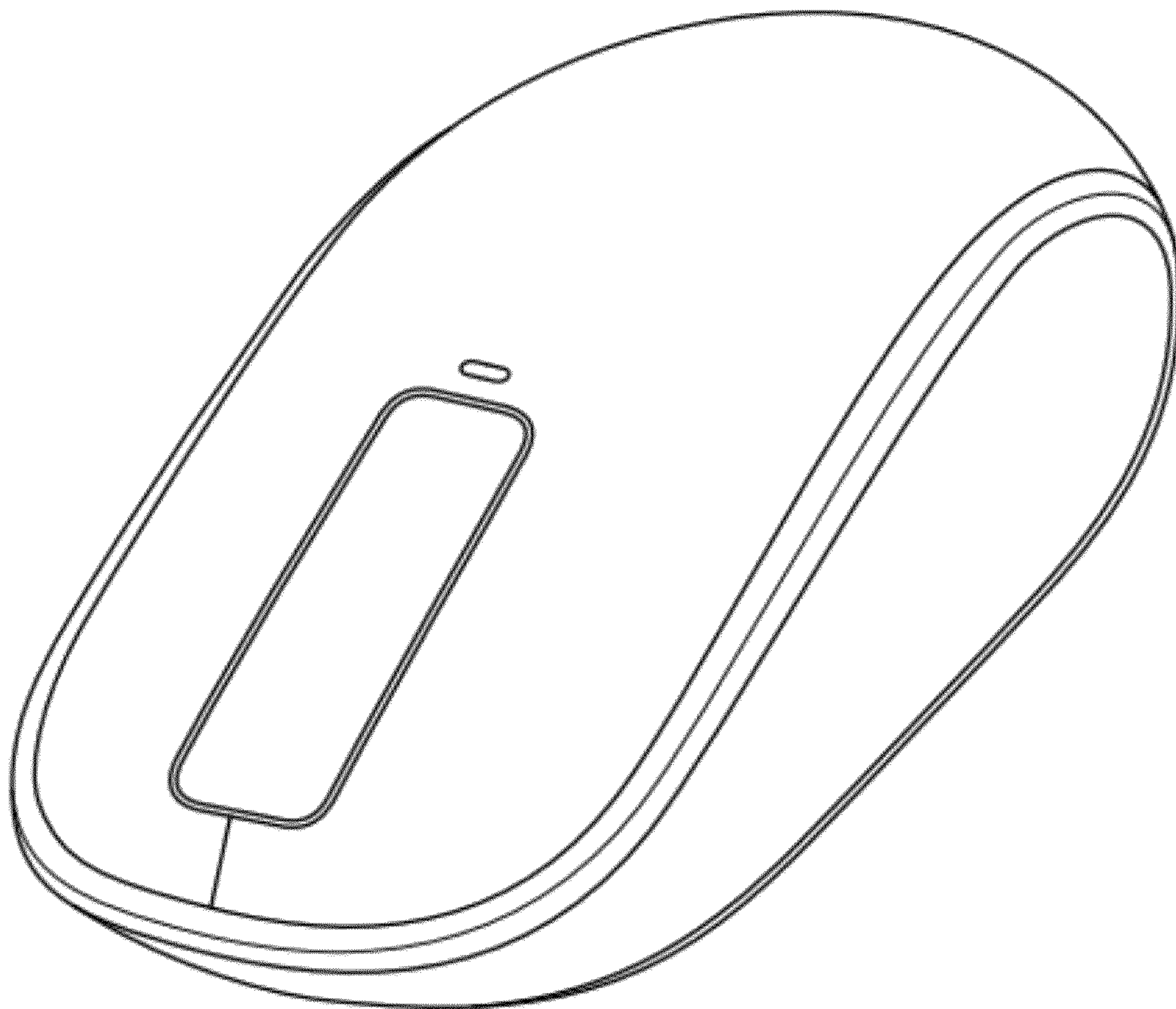

FIG. 8

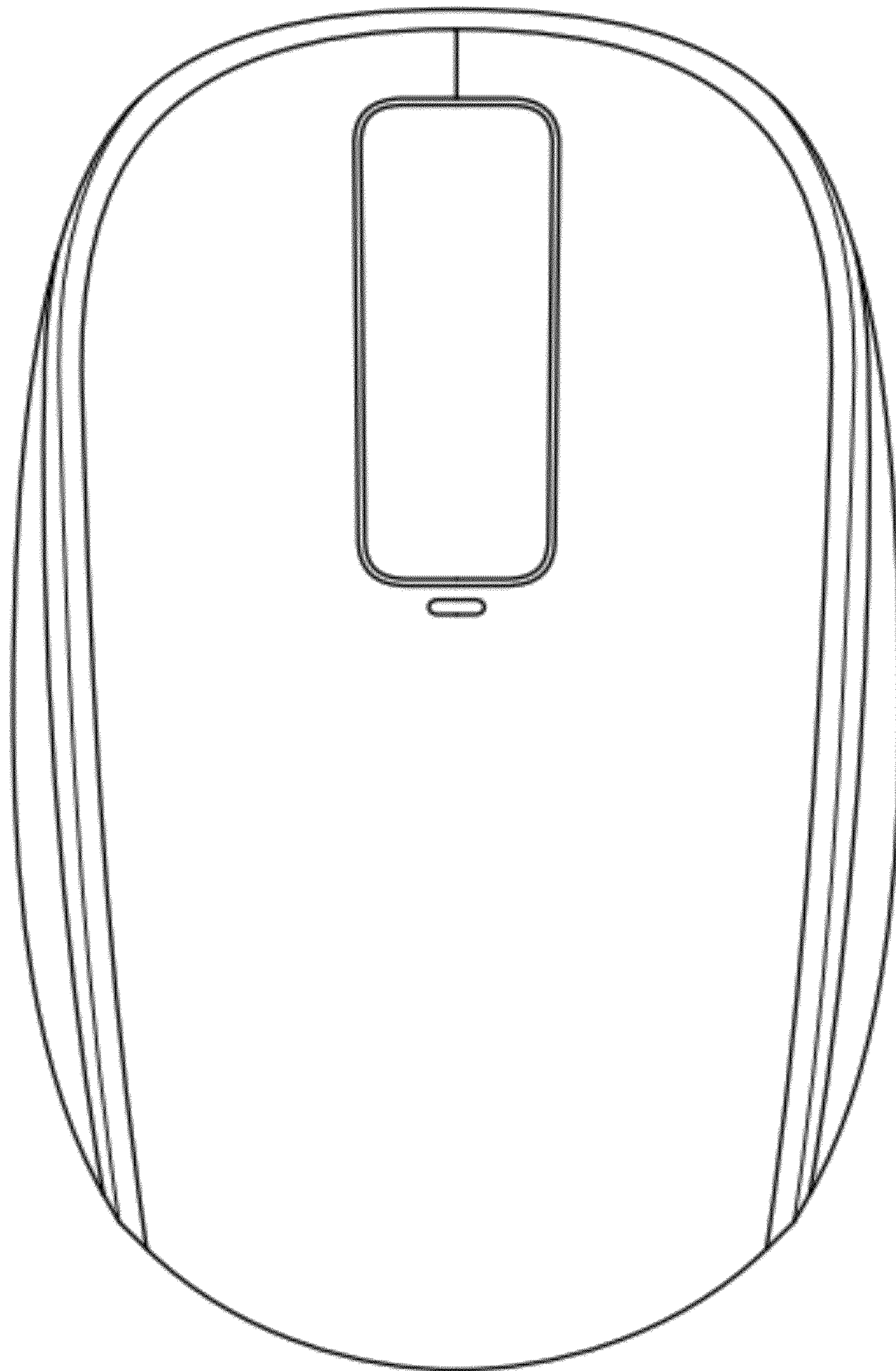

FIG. 9

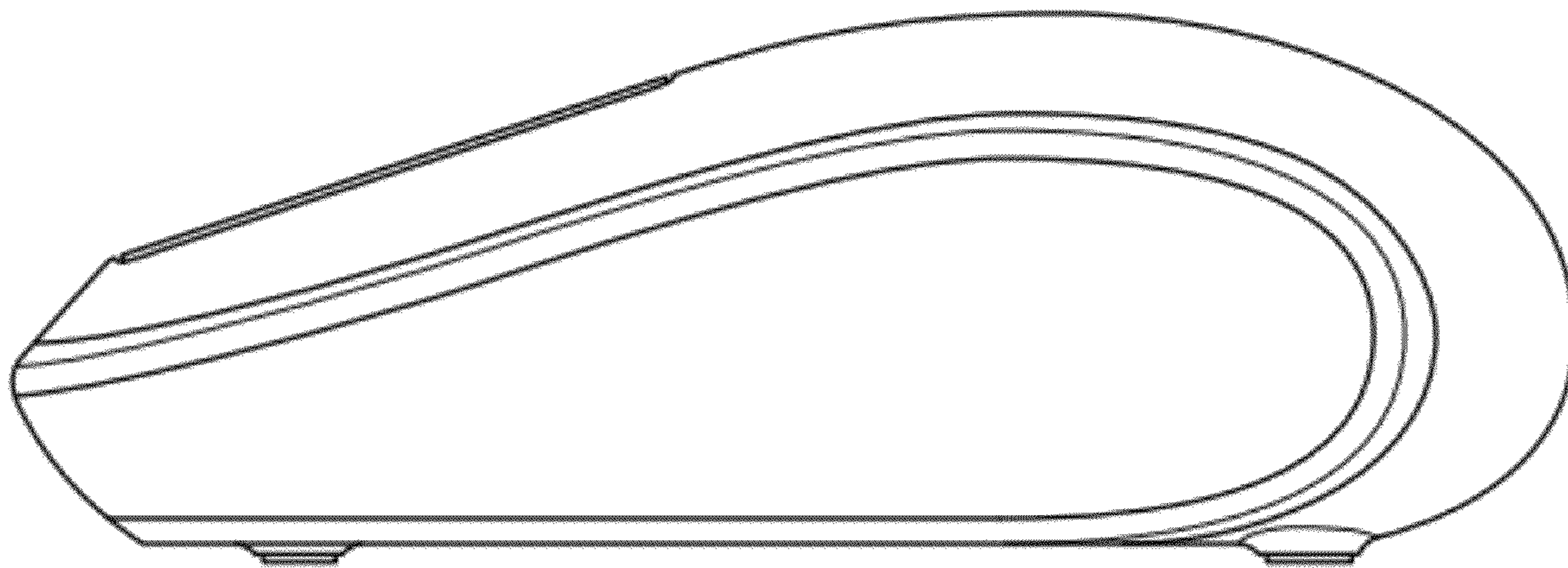

FIG. 10

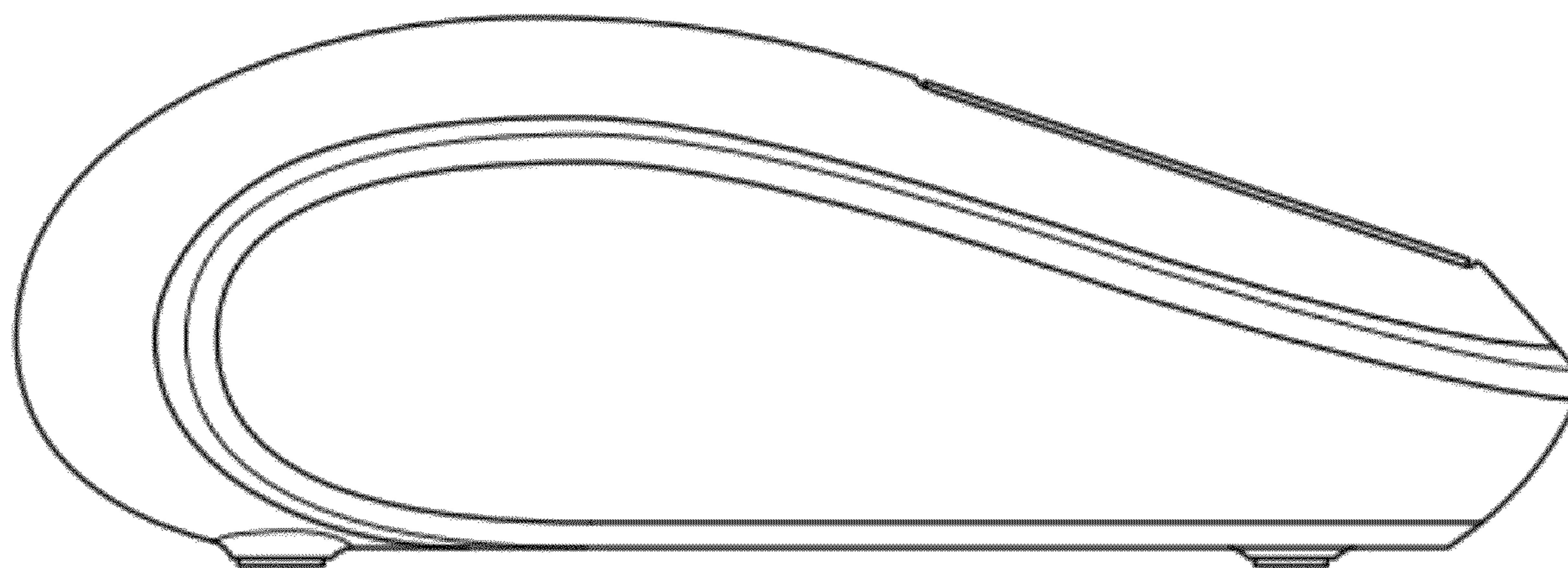

FIG. 11

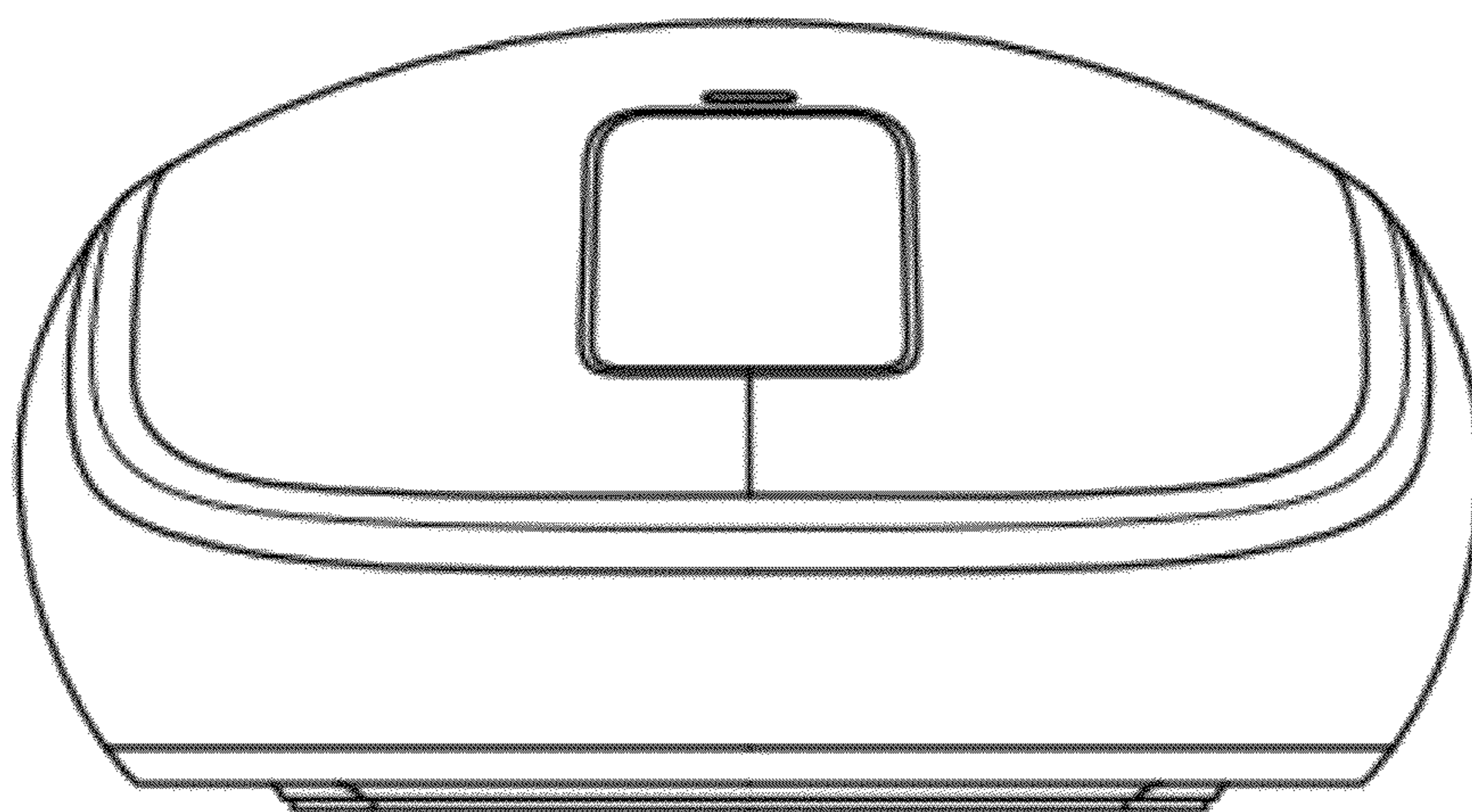

FIG. 12

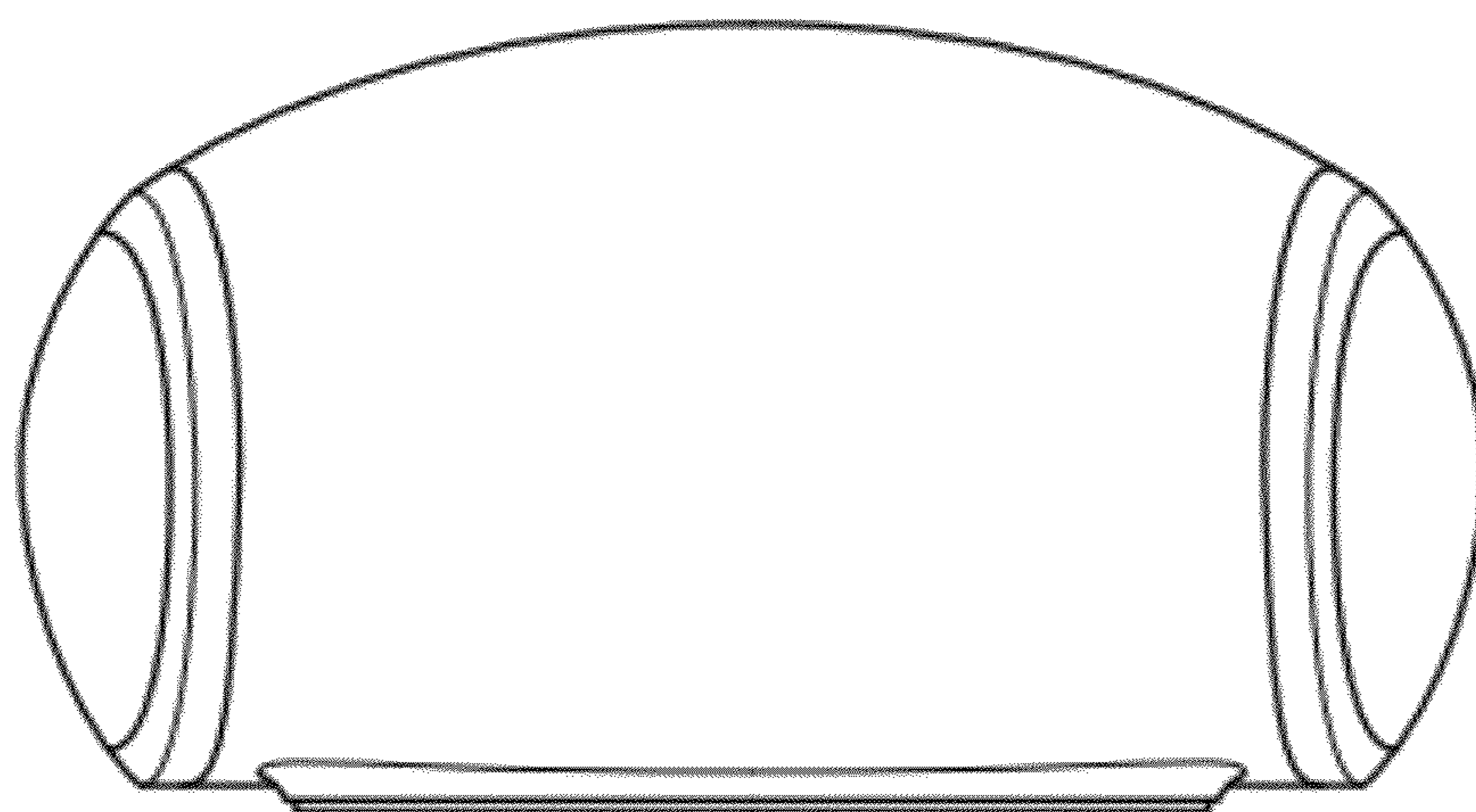

FIG. 13

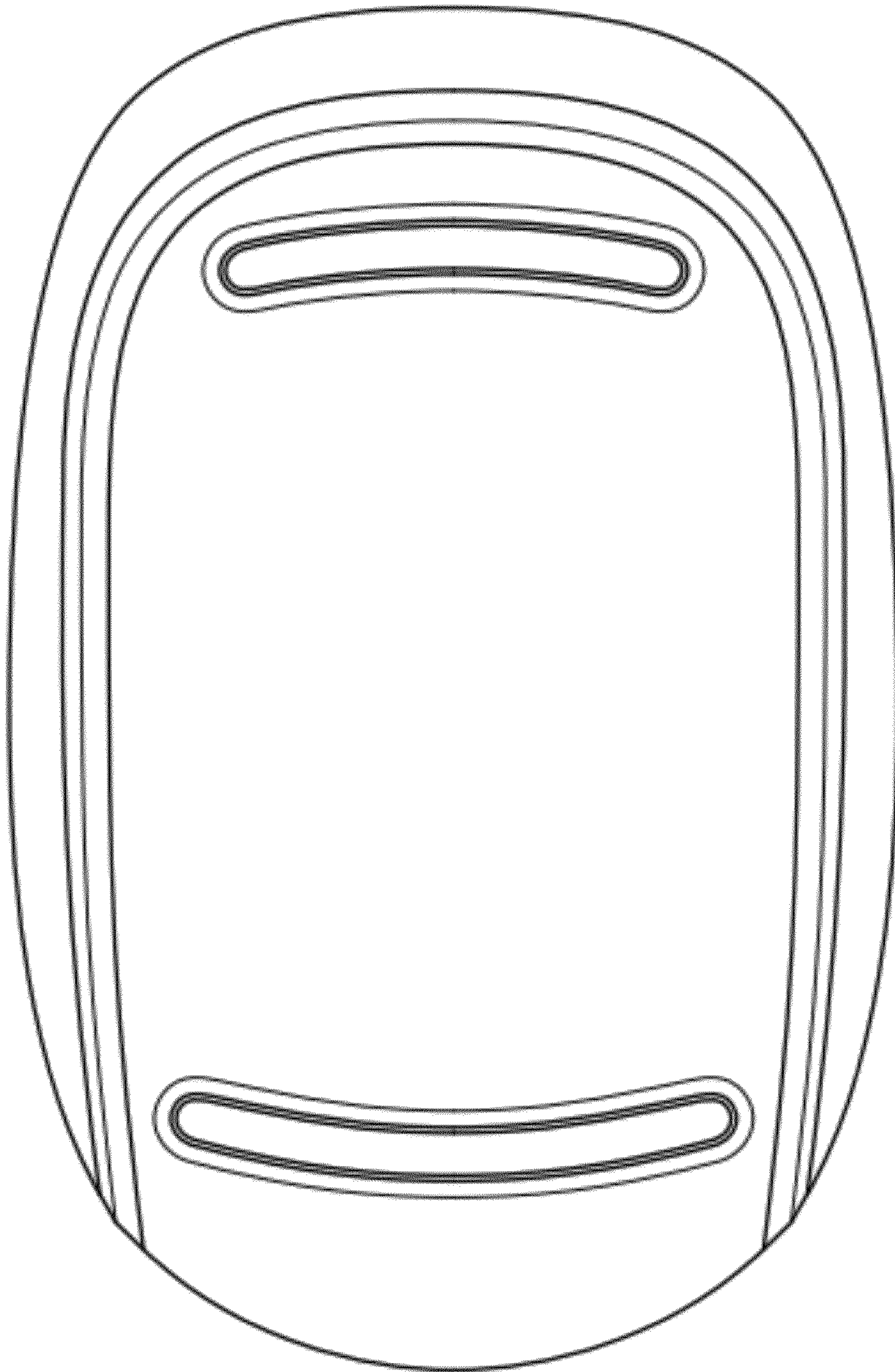

FIG. 14