



US00D656368S

(12) **United States Design Patent**  
**Segal**

(10) **Patent No.:** **US D656,368 S**  
(45) **Date of Patent:** **\*\* Mar. 27, 2012**

(54) **FOOD CONTAINER**

**DESCRIPTION**

(76) Inventor: **Alexander Segal**, Richmond Hill (CA)  
(\*\*) Term: **14 Years**  
(21) Appl. No.: **29/395,178**  
(22) Filed: **Dec. 14, 2011**  
(51) **LOC (9) Cl.** ..... **07-07**  
(52) **U.S. Cl.** ..... **D7/629**  
(58) **Field of Classification Search** ..... D7/601,  
D7/602, 629, 538-542, 612-615; D9/424-432;  
220/780-806, 675, 574-575, 236, 326, 4.23-4.25,  
220/256.1  
See application file for complete search history.

(56) **References Cited**

**U.S. PATENT DOCUMENTS**

4,787,527	A *	11/1988	Monetti	220/557
4,819,824	A *	4/1989	Longbottom et al.	220/266
4,976,370	A *	12/1990	Cassel	220/792
D351,090	S *	10/1994	Narsutis	D7/629
D439,159	S *	3/2001	Chen	D9/425
D440,470	S	4/2001	Tucker et al.	
D449,495	S *	10/2001	Tucker et al.	D7/629

(Continued)

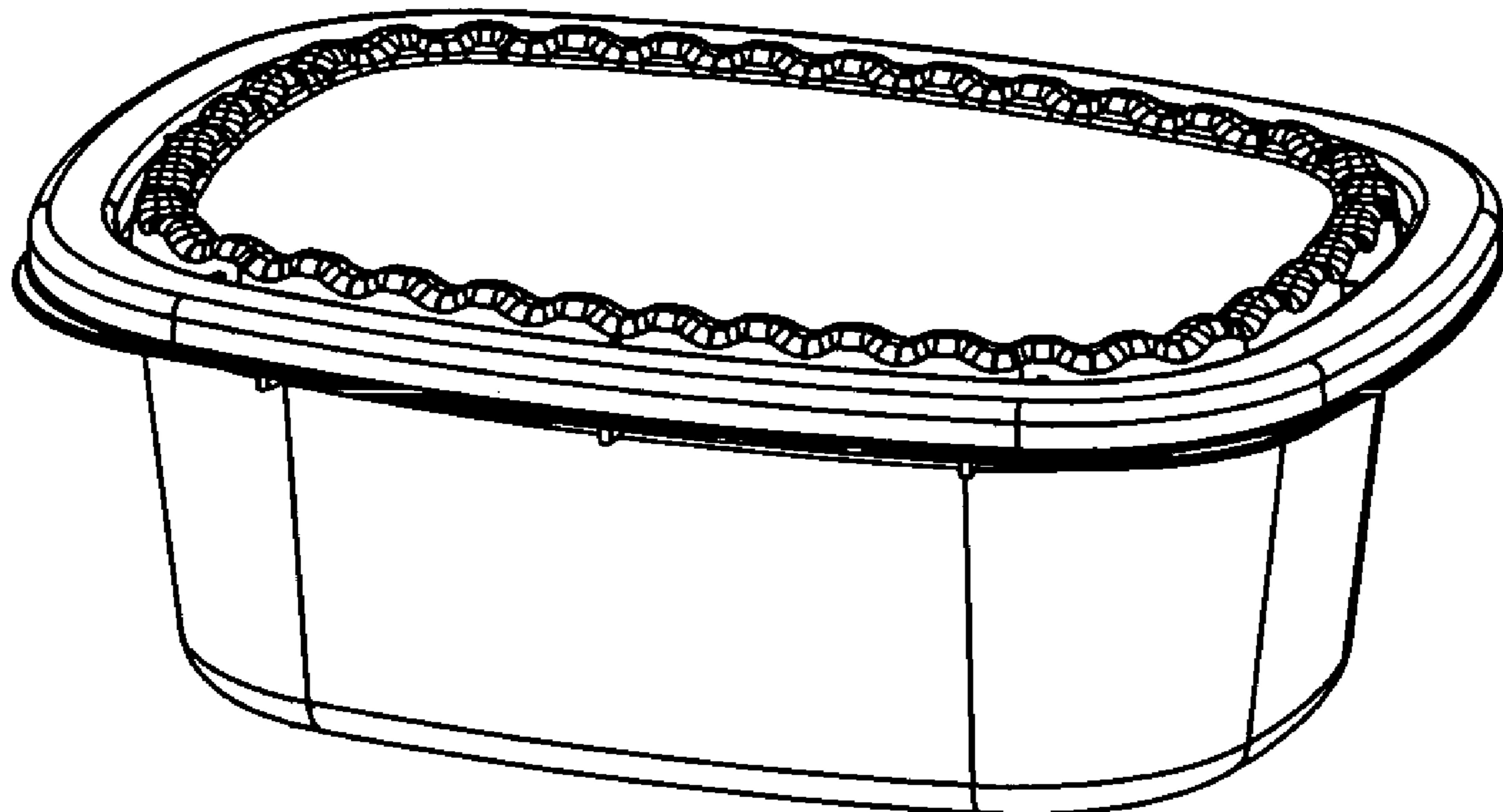
*Primary Examiner* — Terry Wallace  
(74) *Attorney, Agent, or Firm* — Alex Porat

(57) **CLAIM**

The ornamental design for a food container, as shown and described.

FIG. 1 is a top perspective view showing my new design for a food container, including a base and a lid.  
FIG. 2 is a top perspective view of the food container shown in FIG. 1, with the lid separated from the base.  
FIG. 3 is bottom perspective view of the food container shown in FIG. 1, with the lid separated from the base.  
FIG. 4 is a side view of the food container shown in FIG. 1.  
FIG. 5 is a side view of the food container shown in FIG. 1, with the lid separated from the base.  
FIG. 6 is an end view of the food container shown in FIG. 1.  
FIG. 7 is an end view of the food container shown in FIG. 1, with the lid separated from the base.  
FIG. 8 is a top view of the lid of the food container shown in FIG. 1.  
FIG. 9 is a top view of the base of the food container shown in FIG. 1.  
FIG. 10 a top perspective view of an alternate size embodiment of my new design for a food container, including a base and a lid.  
FIG. 11 is a top perspective view of the food container shown in FIG. 10, with the lid separated from the base.  
FIG. 12 is bottom perspective view of the food container shown in FIG. 10, with the lid separated from the base.  
FIG. 13 is a side view of the food container shown in FIG. 10.  
FIG. 14 is a side view of the food container shown in FIG. 10, with the lid separated from the base.  
FIG. 15 is an end view of the food container shown in FIG. 10.  
FIG. 16 is an end view of the food container shown in FIG. 10, with the lid separated from the base.  
FIG. 17 is a top view of the lid of the food container shown in FIG. 10; and,  
FIG. 18 is a top view of the base of the food container shown in FIG. 10.

**1 Claim, 16 Drawing Sheets**



# US D656,368 S

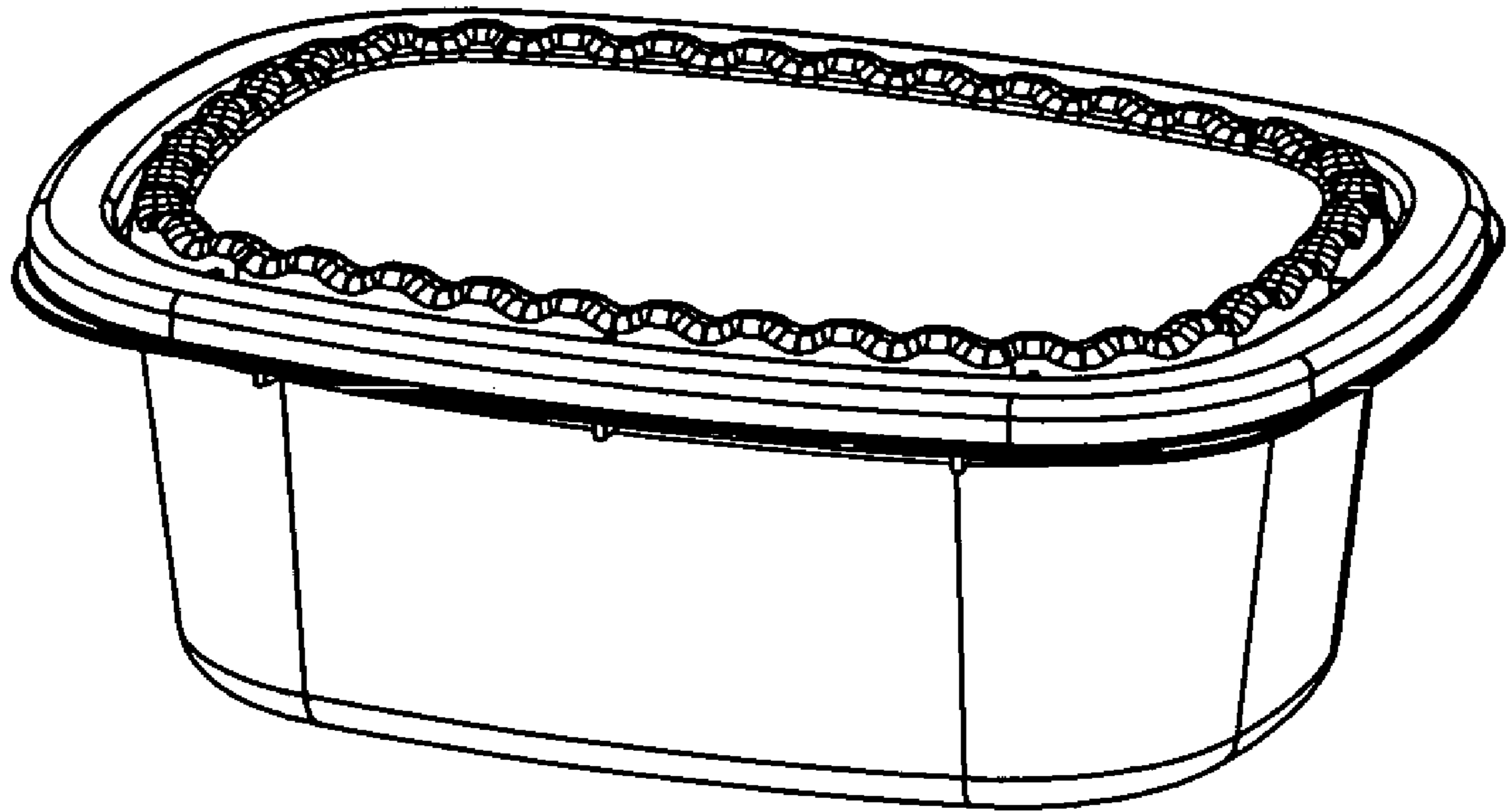
Page 2

---

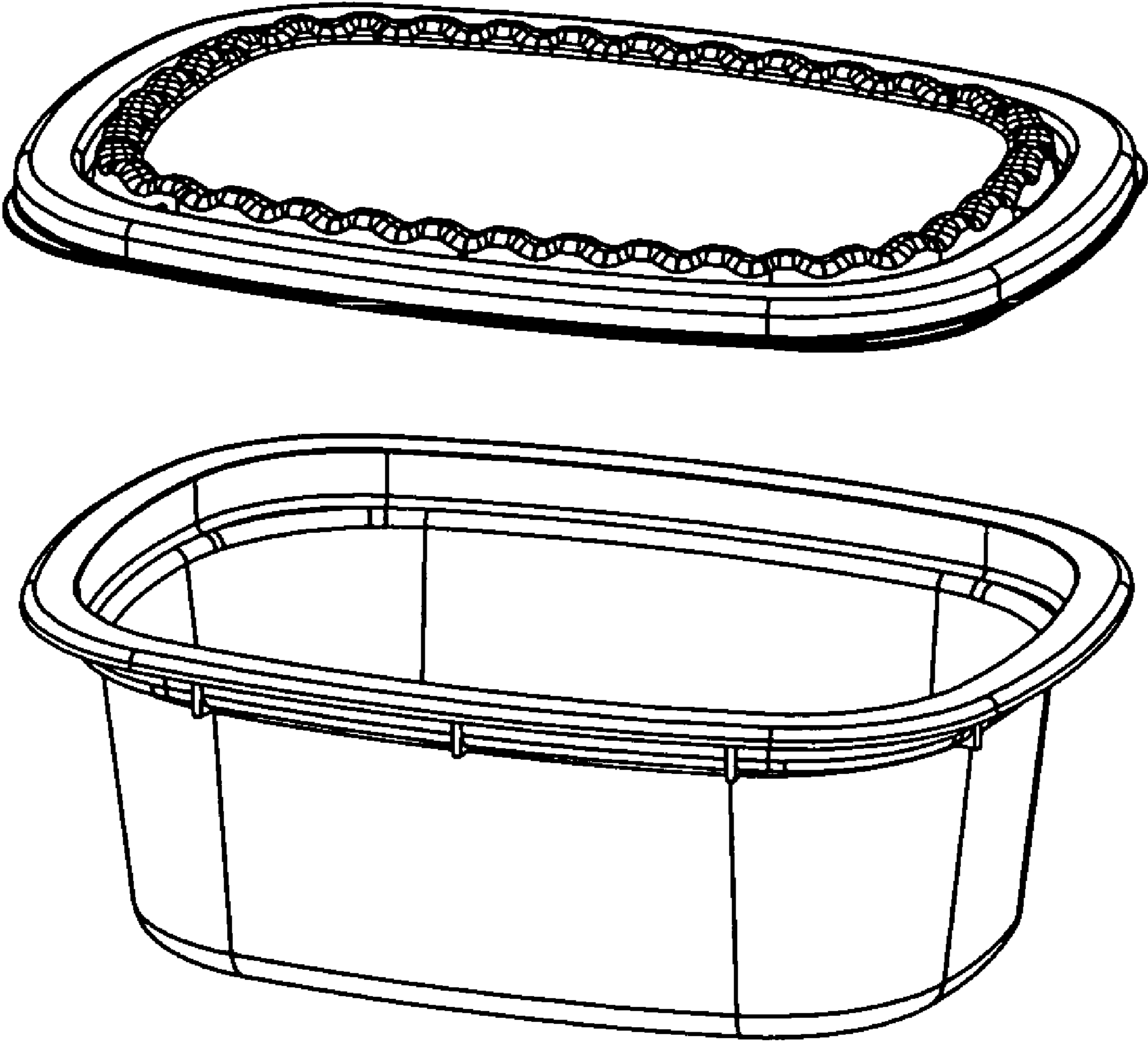
## U.S. PATENT DOCUMENTS

D469,689 S *	2/2003	Buchalski et al. ....	D9/425	D606,812 S *	12/2009	Wu .....	D7/629
D483,622 S	12/2003	Kim		D610,878 S *	3/2010	Kim .....	D7/629
D541,598 S *	5/2007	Kim .....	D7/629	D611,807 S *	3/2010	Miga, Jr. ....	D9/424
D546,632 S *	7/2007	Oberloier .....	D7/629	D614,919 S *	5/2010	Carlson .....	D7/602
D551,515 S *	9/2007	Ablo et al. ....	D7/629	D614,950 S *	5/2010	Colacitti .....	D9/425
D568,693 S	5/2008	Furlong		D618,516 S *	6/2010	DiPietro et al. ....	D7/629
D591,112 S	4/2009	Wang					

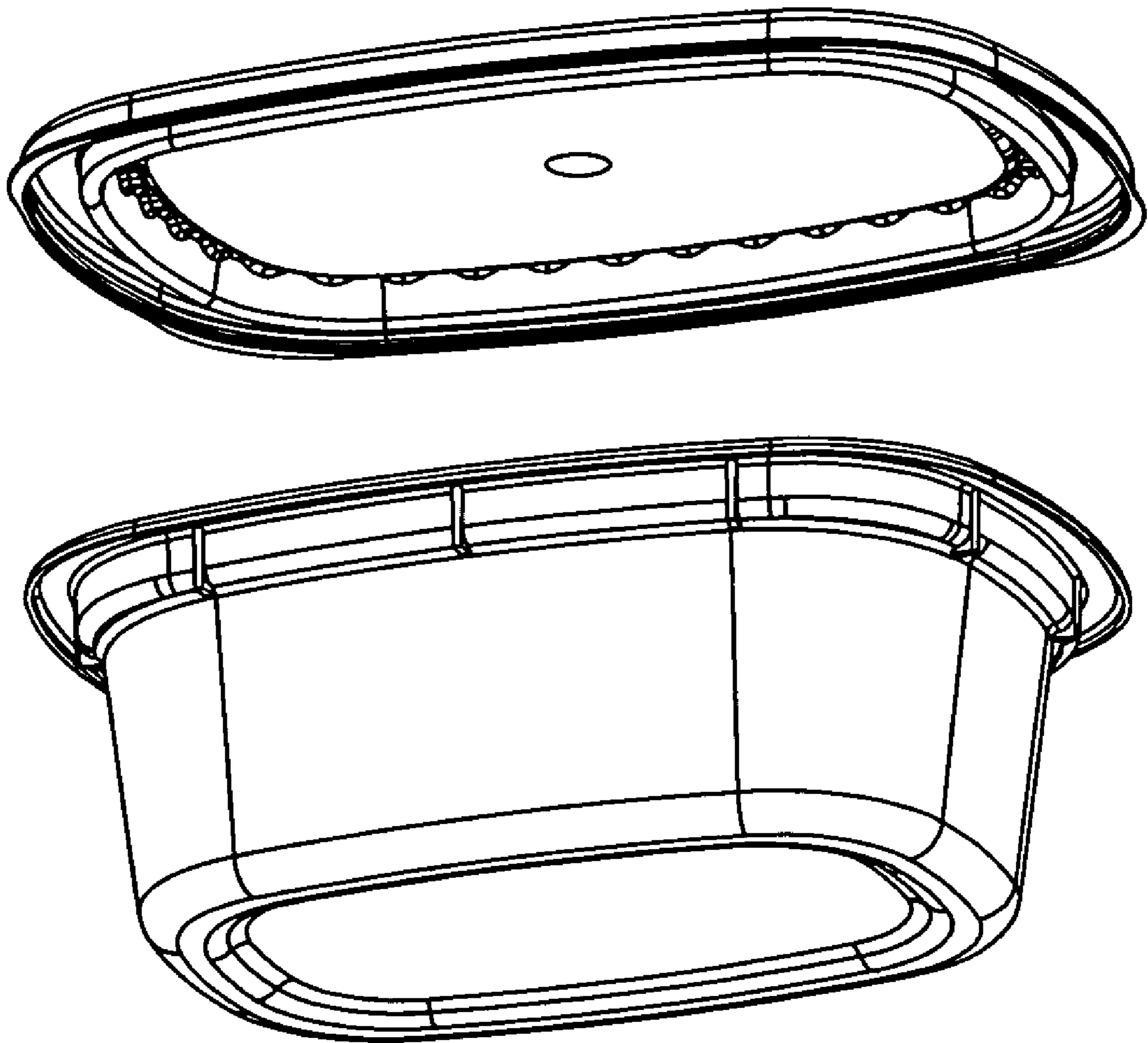
\* cited by examiner



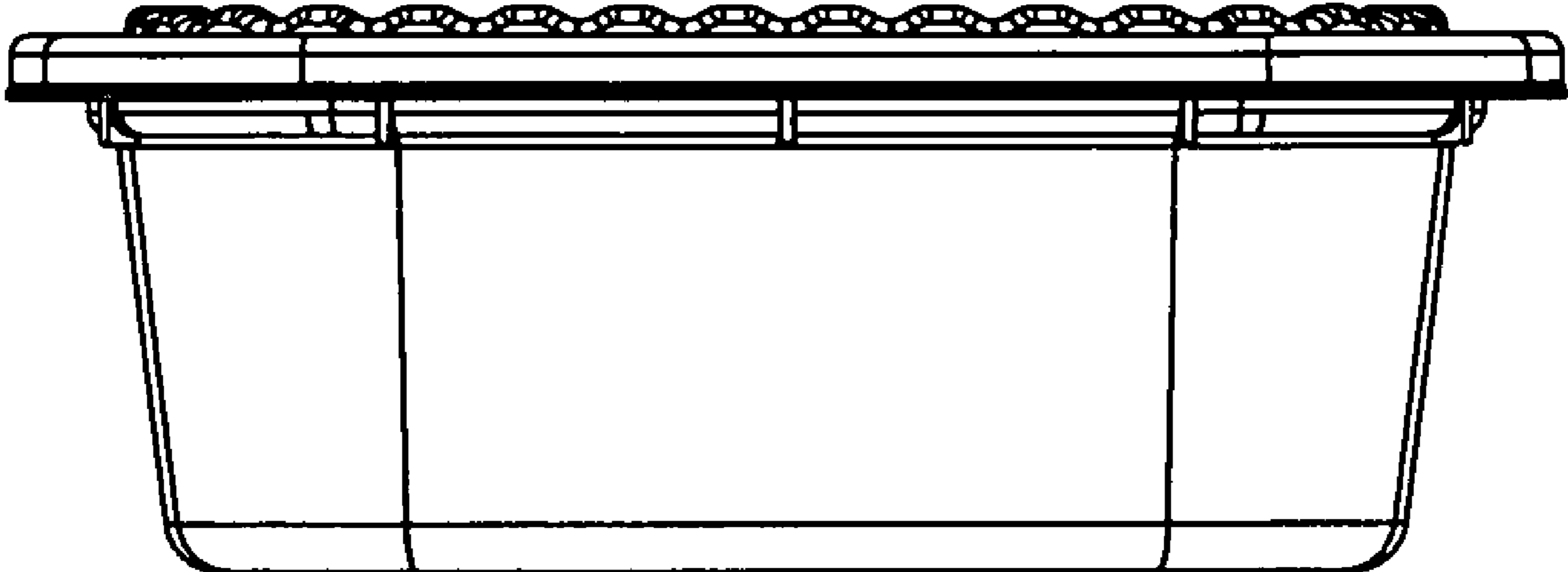
**Fig 1**



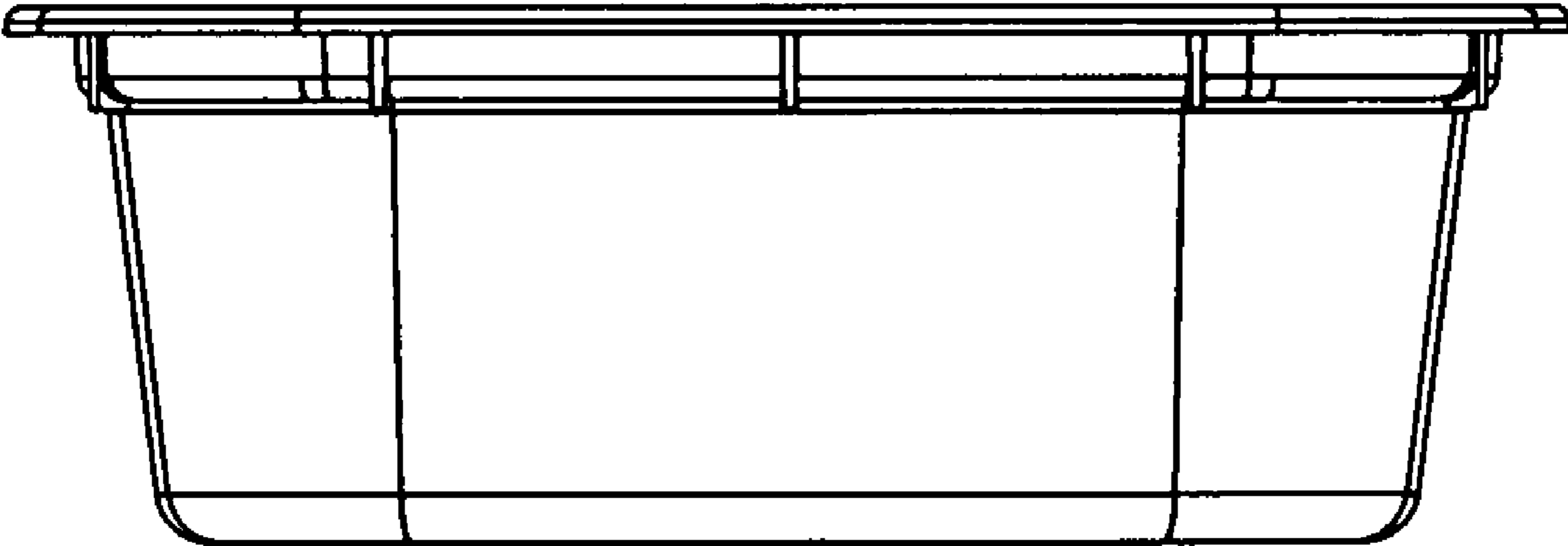
**Fig. 2**



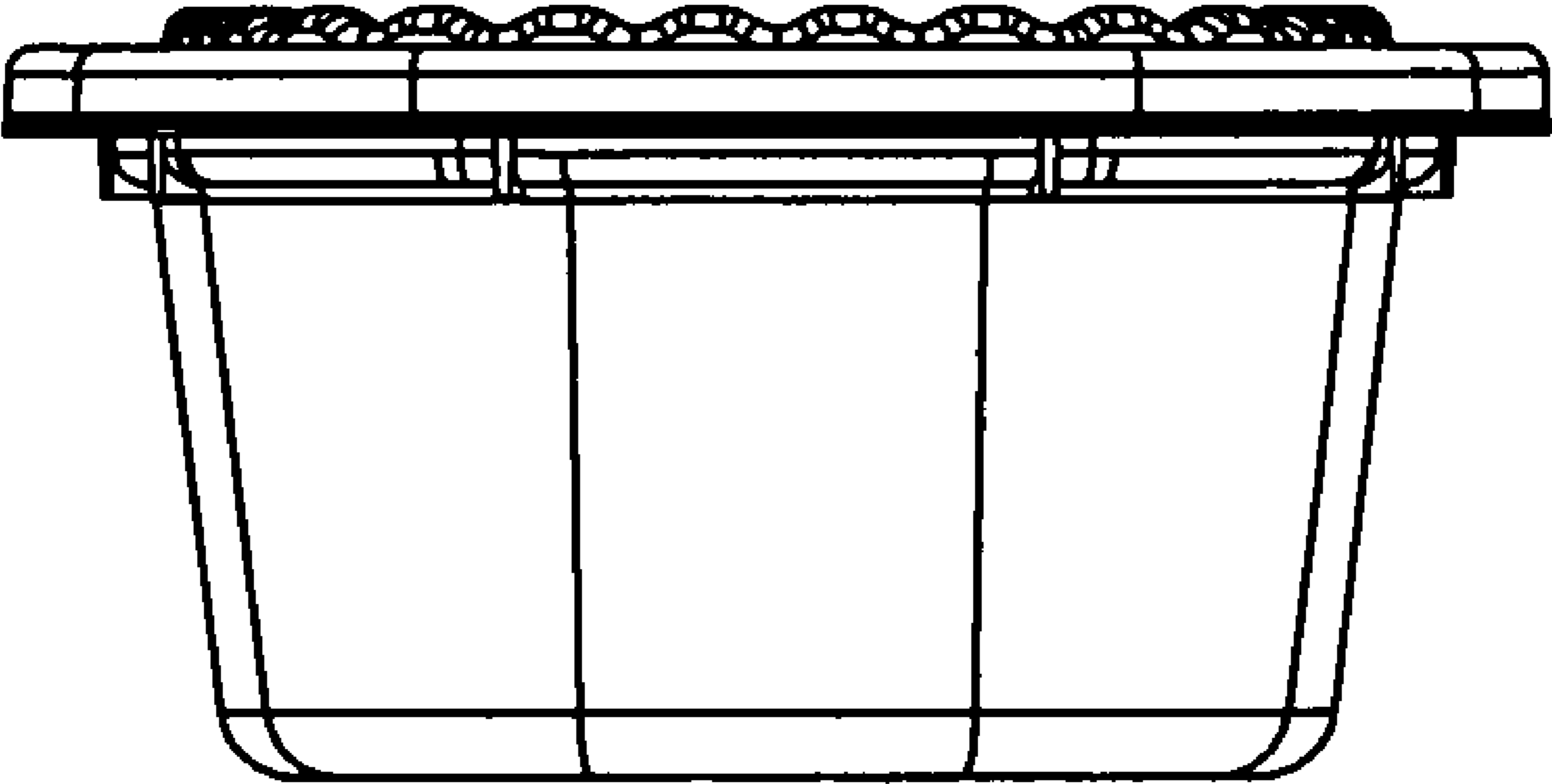
**Fig 3**



**Fig 4**

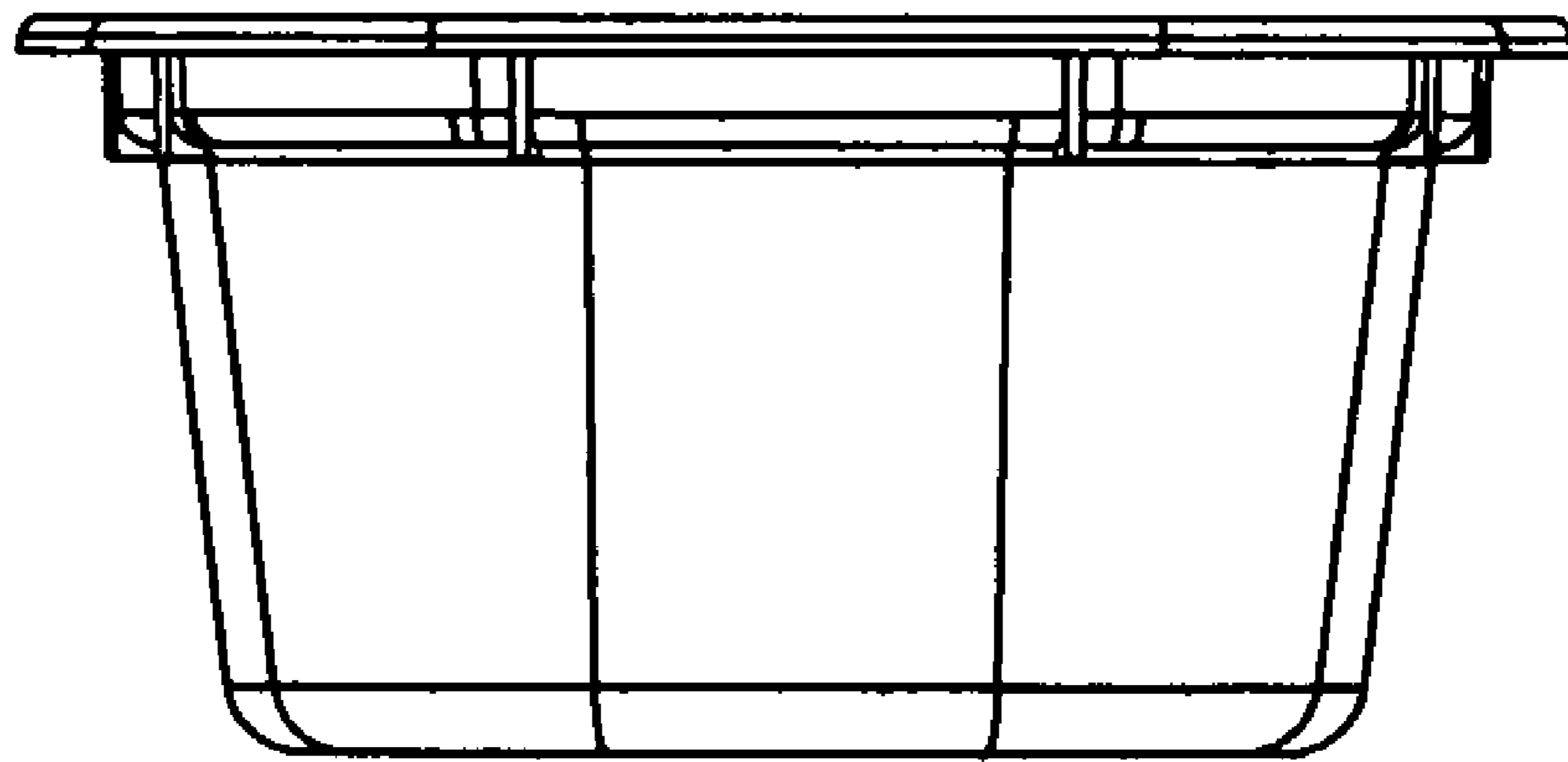


**Fig 5**

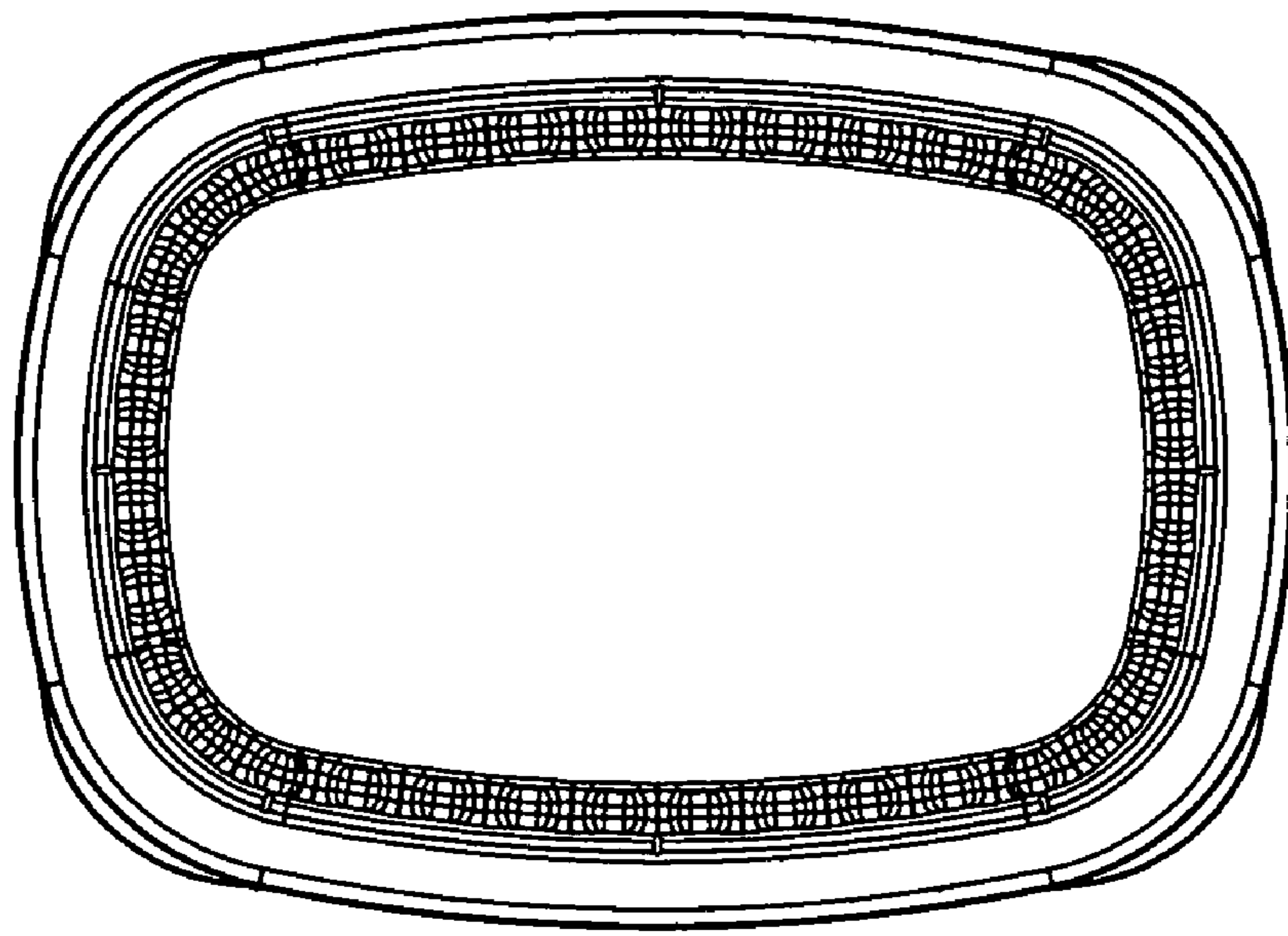


**Fig 6**

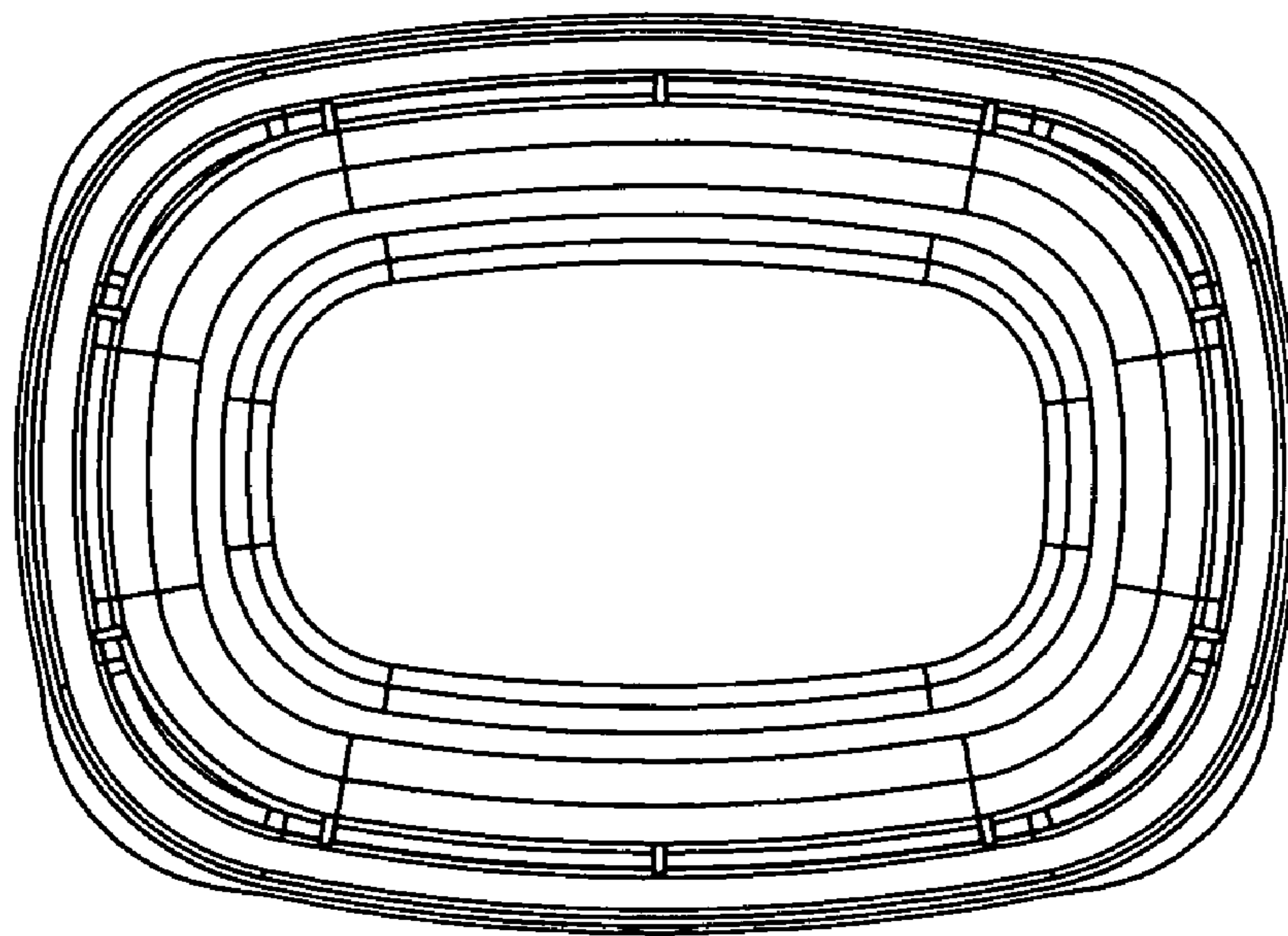




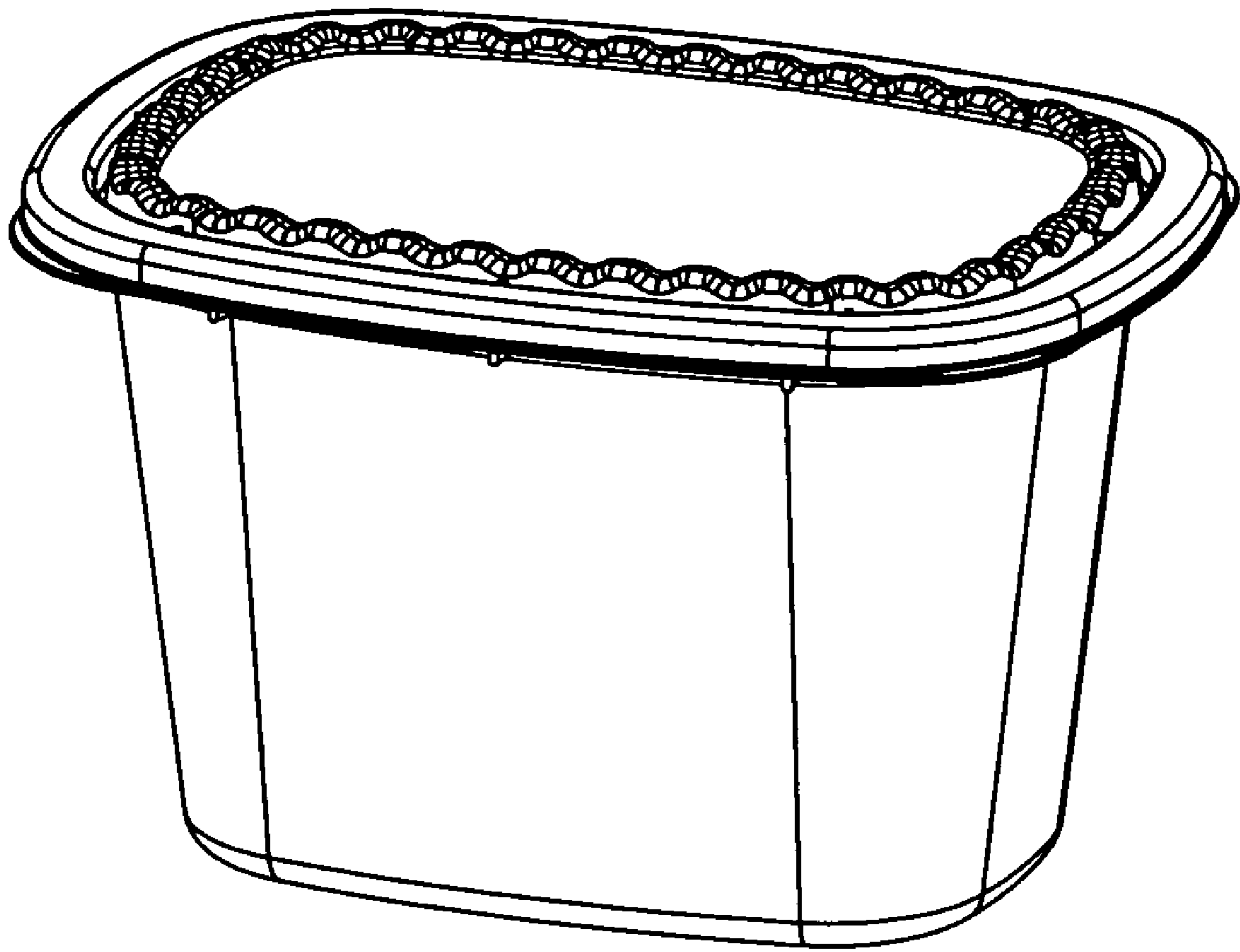
**Fig 7**



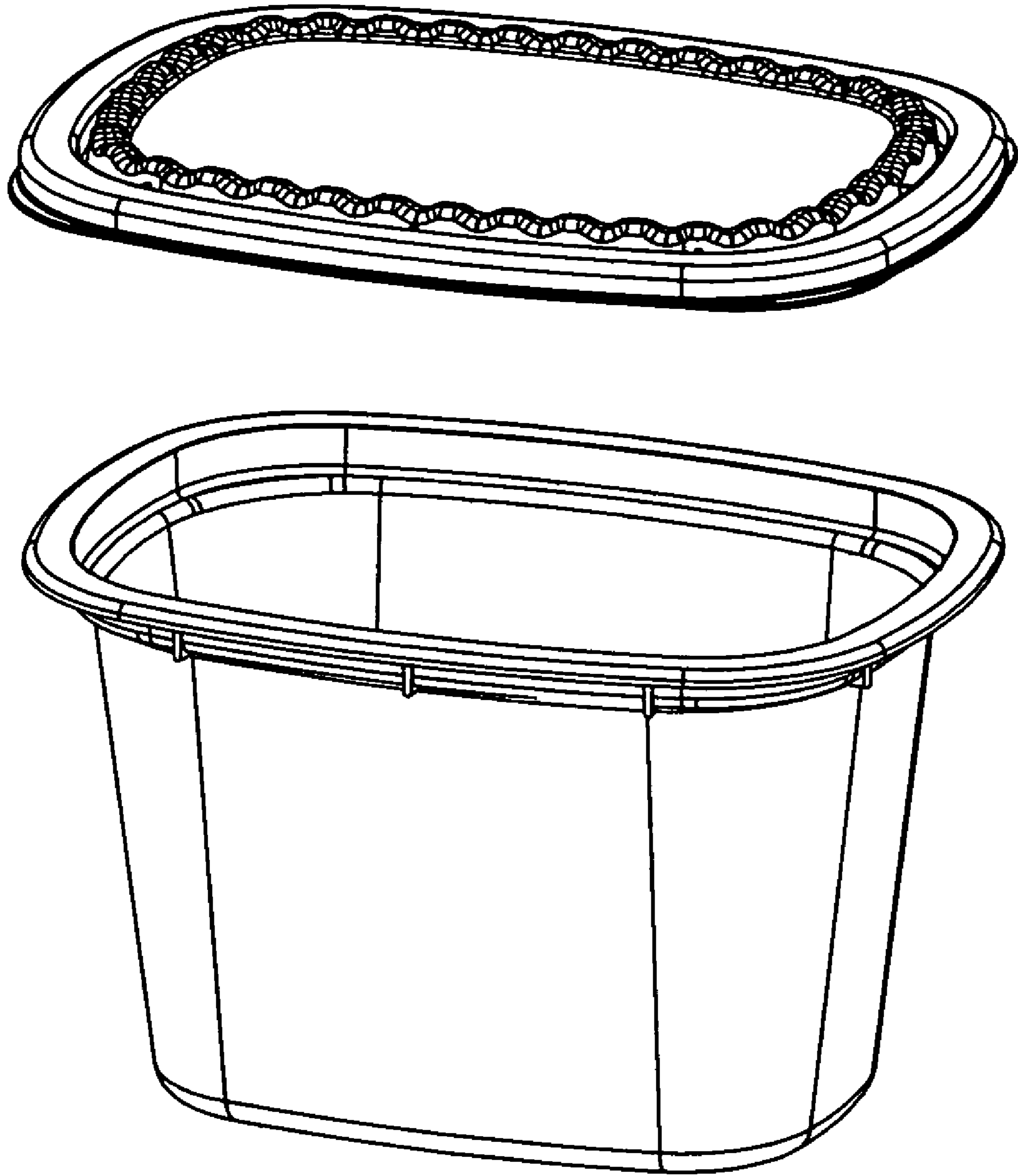
**Fig 8**



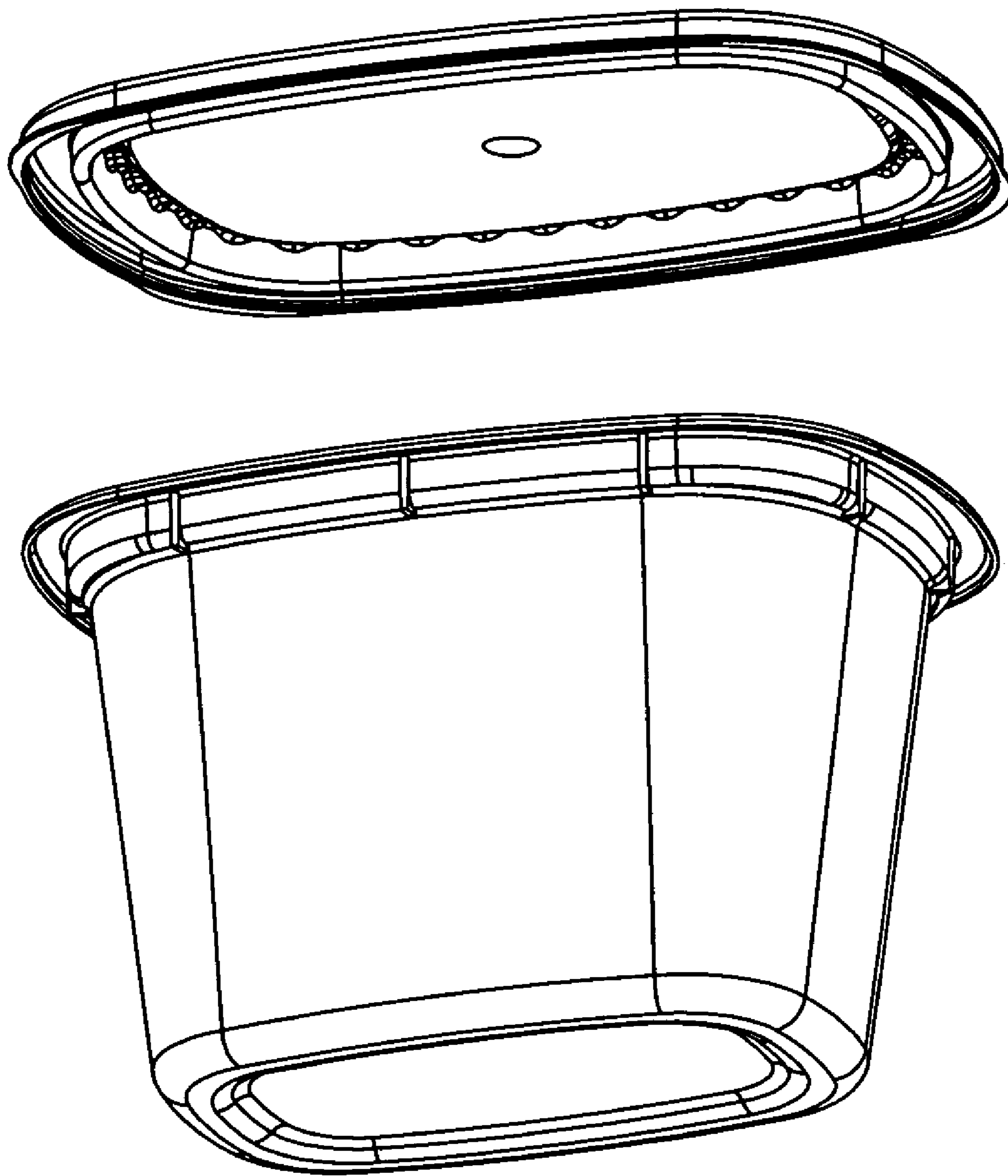
**Fig 9**



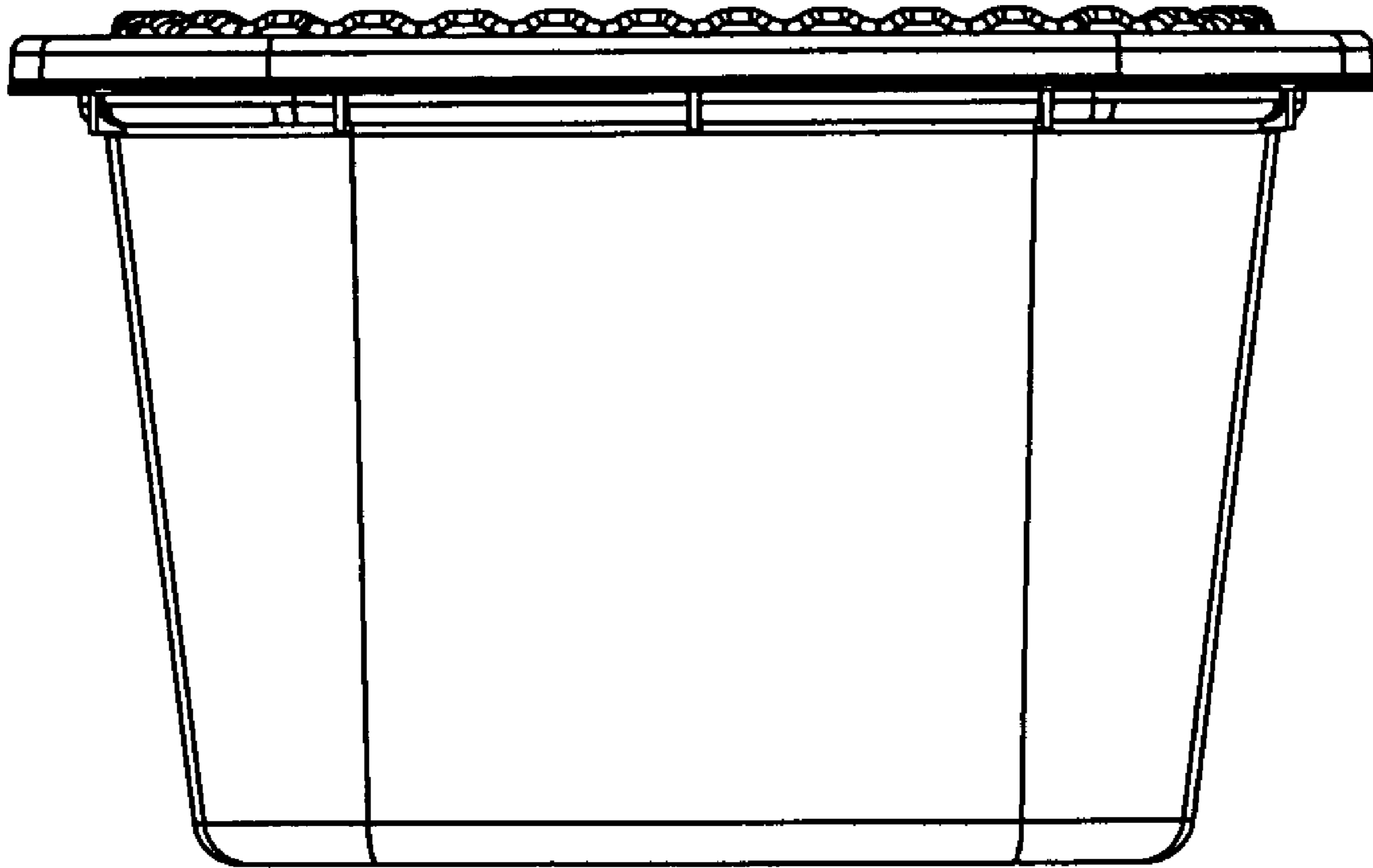
**Fig 10**



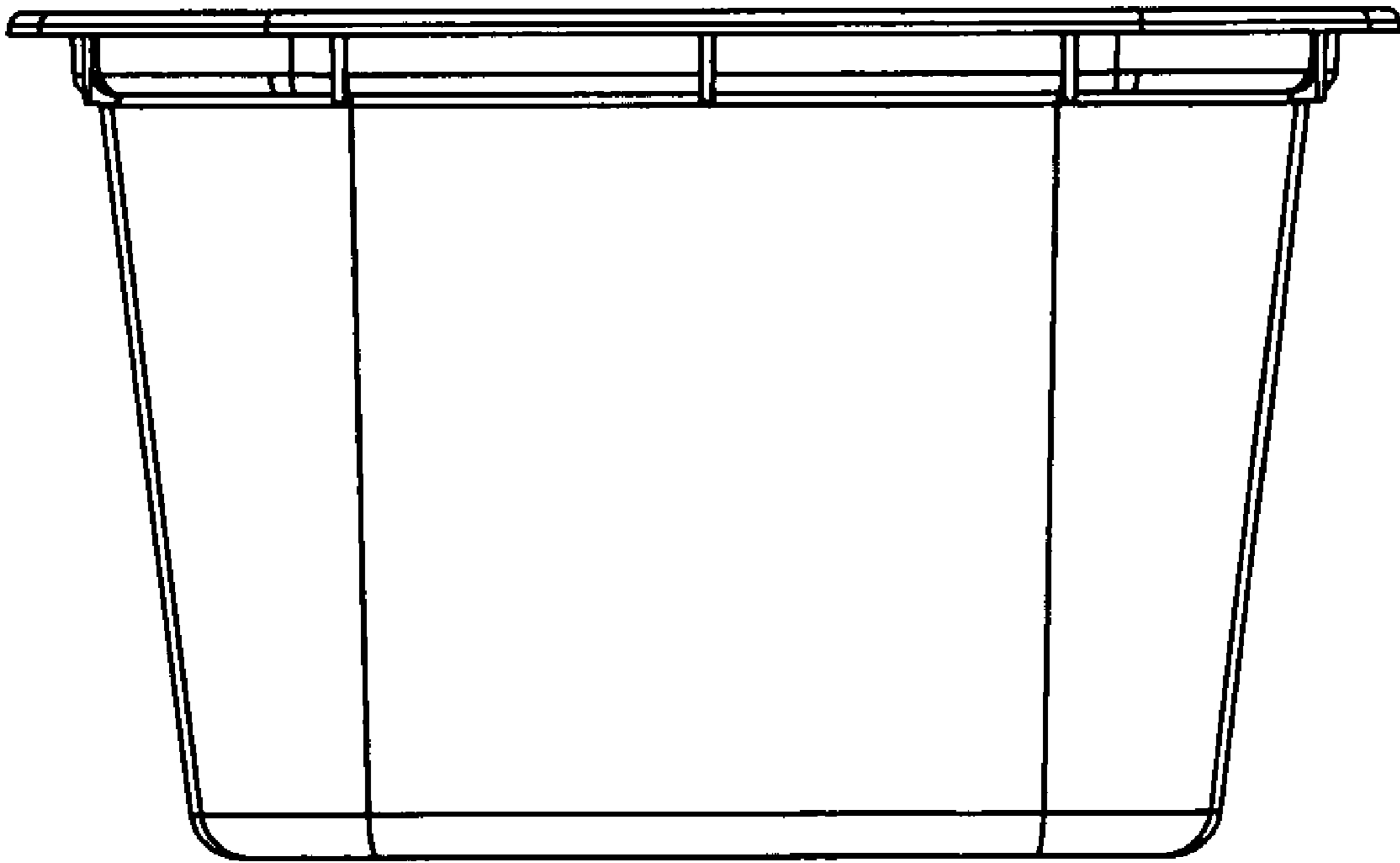
**Fig 11**



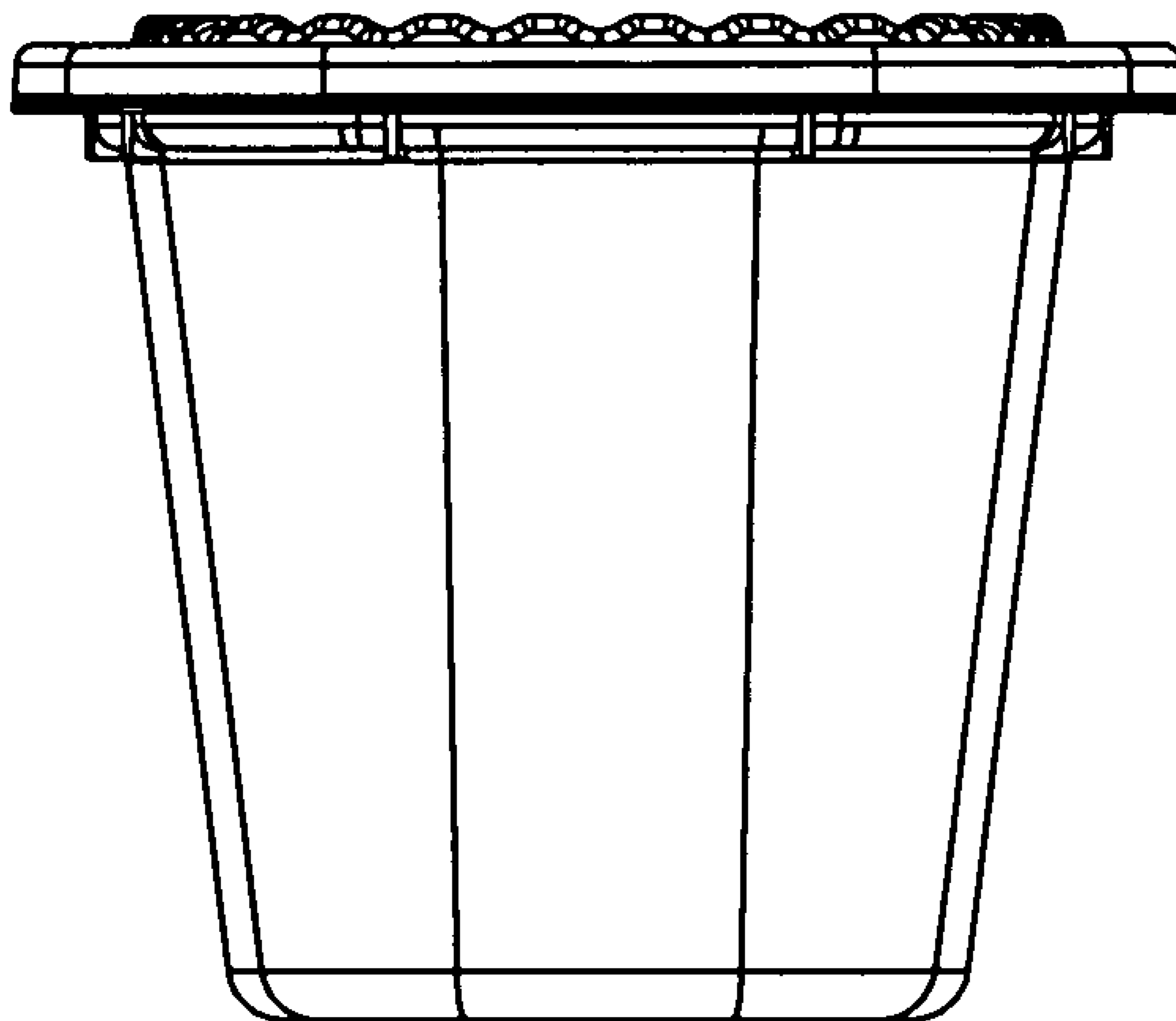
**Fig 12**



**Fig 13**

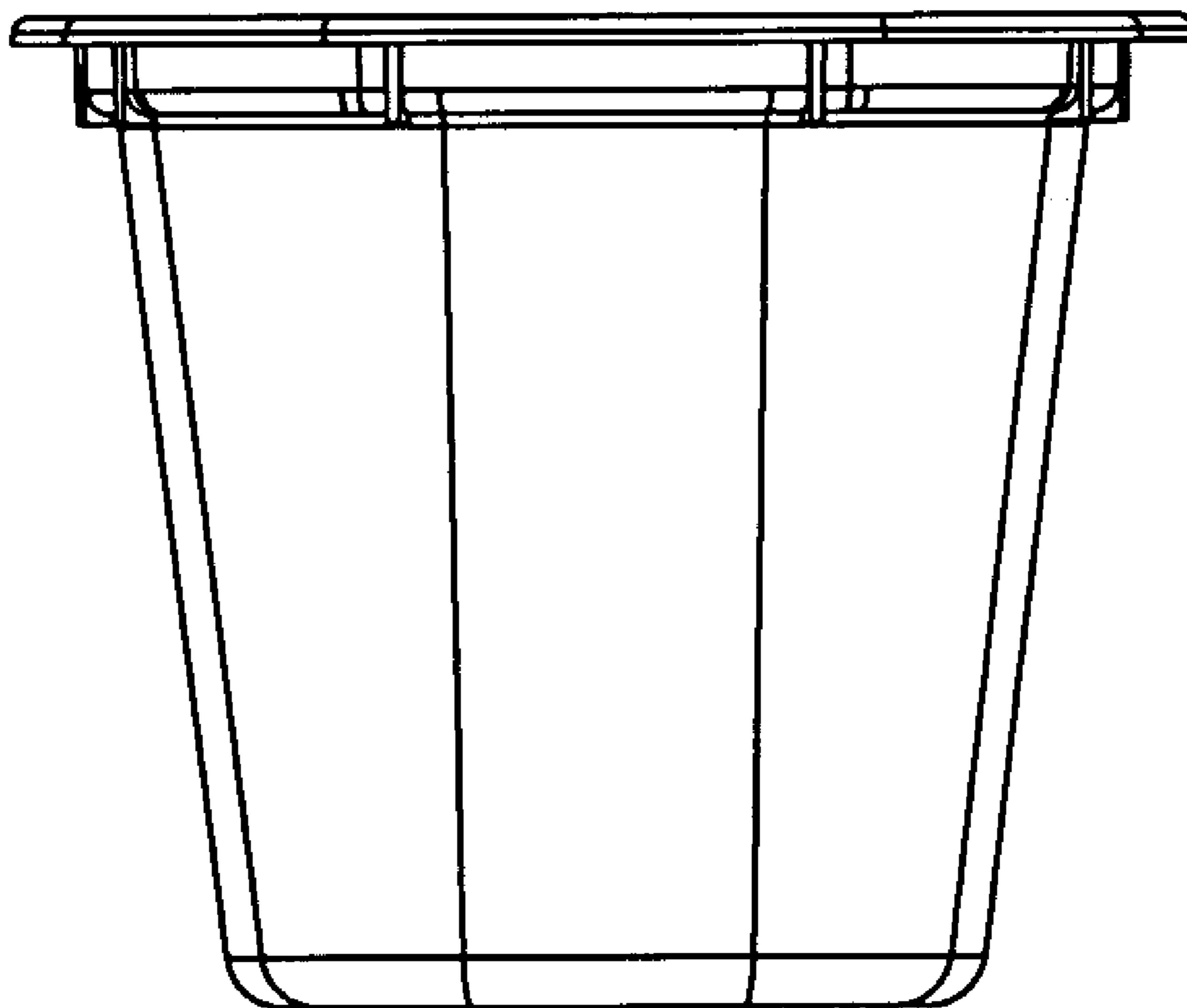


**Fig 14**

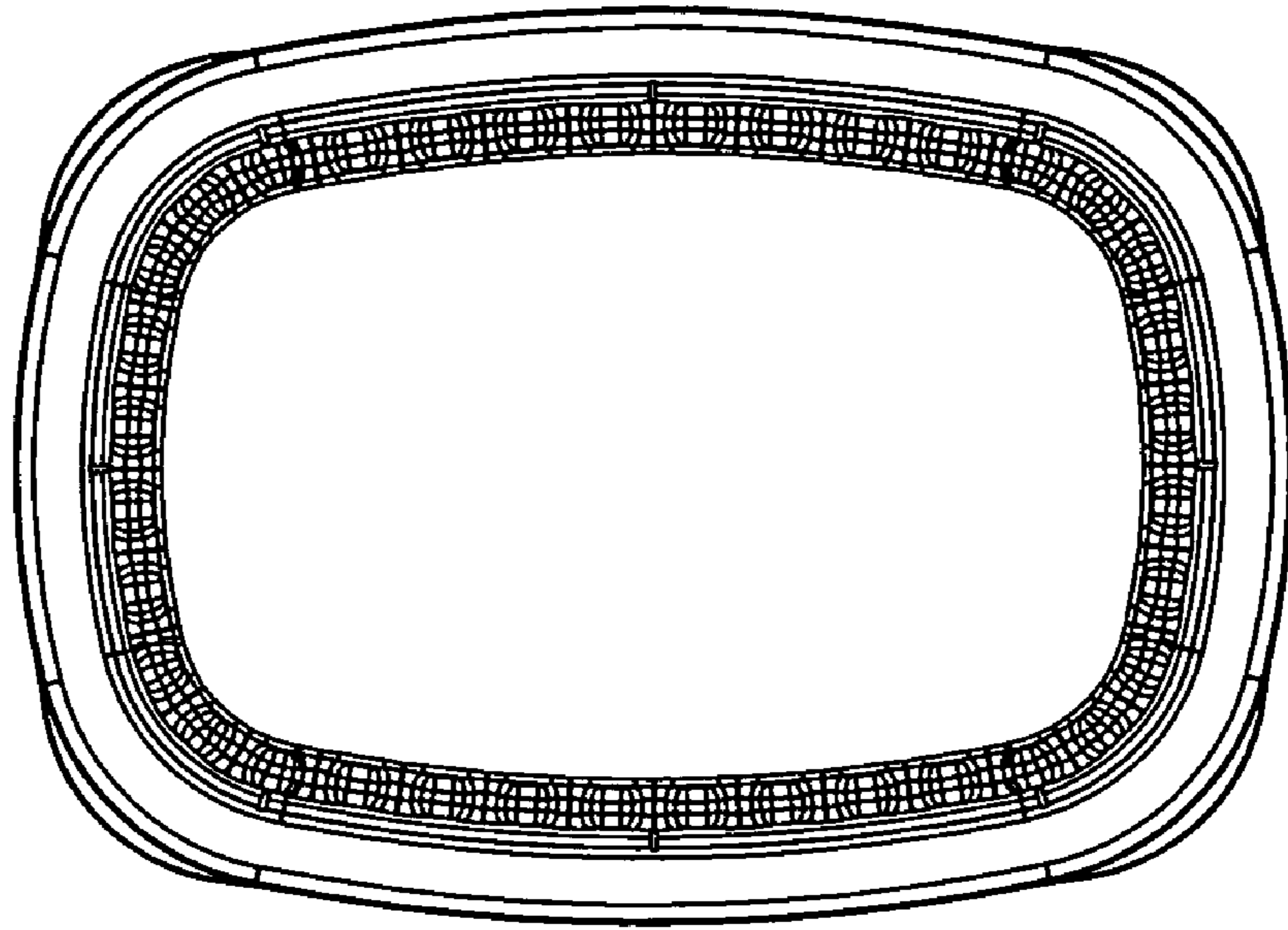


**Fig 15**

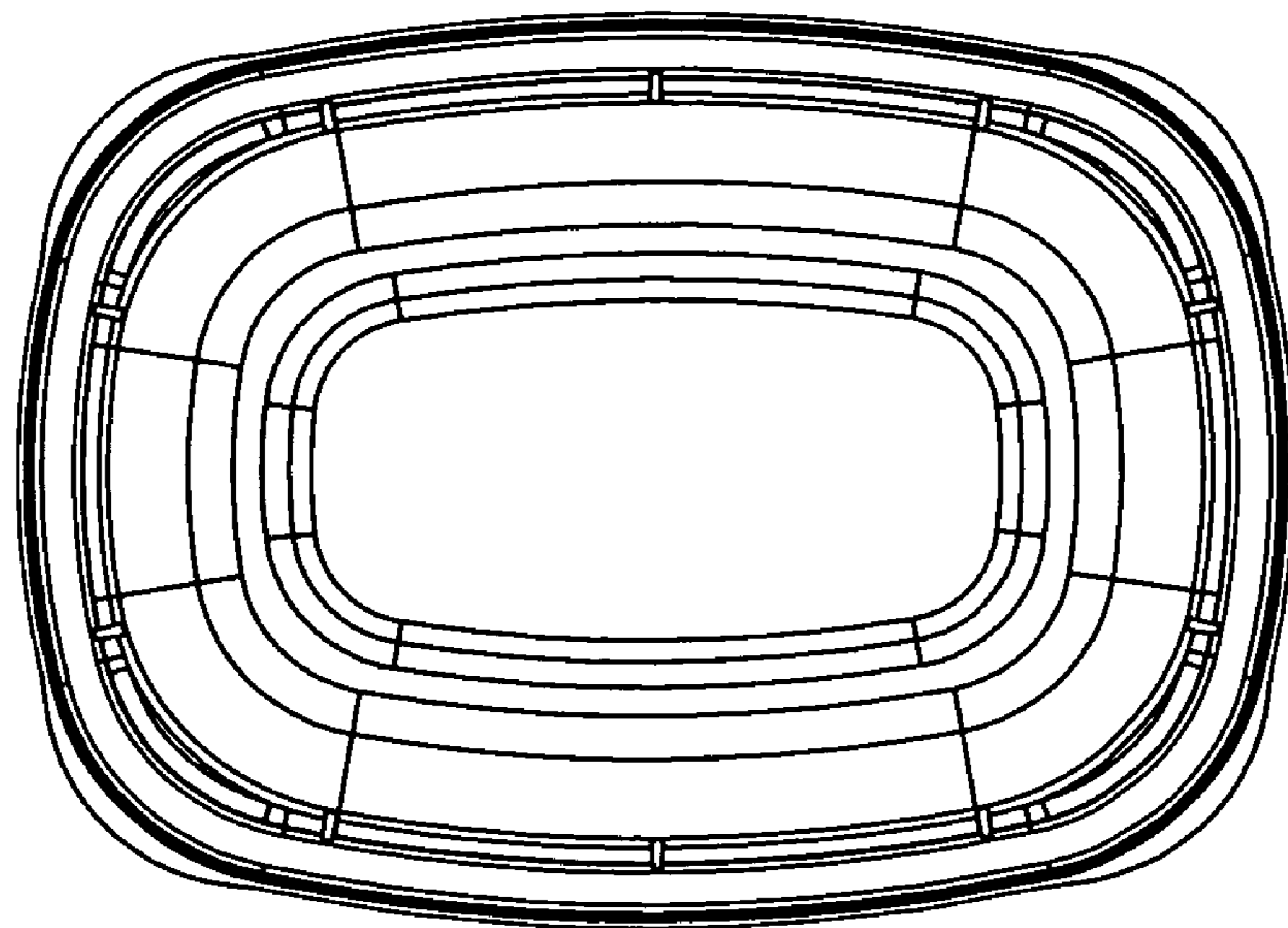




**Fig 16**



**Fig 17**



**Fig 18**