



US00D656358S

(12) **United States Design Patent**
Cloutier et al.

(10) **Patent No.:** **US D656,358 S**

(45) **Date of Patent:** **** Mar. 27, 2012**

(54) **COOKING PAN WITH STRAINER**
(75) Inventors: **Andre Dean Cloutier**, Blaine, WA (US);
Debra Lynne Sasken-Duff, Blaine, WA (US)

(73) Assignee: **Magellan Group Ltd**, Blaine, WA (US)

(**) Term: **14 Years**

(21) Appl. No.: **29/398,207**

(22) Filed: **Jul. 27, 2011**

(51) **LOC (9) Cl.** **07-02**

(52) **U.S. Cl.** **D7/361; D7/354**

(58) **Field of Classification Search** D7/323,
D7/329-332, 337, 339, 346-347, 350.1-350.4,
D7/354-363, 391, 393, 395, 402, 408-409,
D7/505, 538, 542, 549, 587, 667; 99/324-325,
99/331-332, 337-340, 396, 400-418, 425,
99/444-446, 450; 119/161, 166; 126/9 R,
126/25 A, 25 R, 41 R, 166, 275 R, 332, 380.1,
126/390.1; 206/501-505, 507-508; 219/400,
219/405, 435-442, 620-624, 725, 730-735;
220/485, 491, 573.1-573.5, 759, 912; 426/438,
426/441, 523

See application file for complete search history.

(56) **References Cited**

U.S. PATENT DOCUMENTS

D414,981 S * 10/1999 Roskind et al. D7/359
D434,269 S * 11/2000 Jo D7/360
D453,092 S * 1/2002 Coudurier D7/361
D458,798 S * 6/2002 Kellermann D7/360
D467,462 S * 12/2002 Teisen-Simony et al. D7/360
D482,233 S * 11/2003 Rae D7/393
D559,032 S * 1/2008 Kellermann et al. D7/354
D580,214 S * 11/2008 Dodane D7/361

D586,177 S * 2/2009 Loring D7/361
D589,741 S * 4/2009 Gerlach D7/361
D639,604 S * 6/2011 Degnan D7/361

* cited by examiner

Primary Examiner — Ricky Pham

(74) *Attorney, Agent, or Firm* — Dwayne E. Rogge; Hughes Law Firm, PLLC

(57) **CLAIM**

The ornamental design for a cooking pan with strainer, as shown and described.

DESCRIPTION

FIG. 1 is a perspective view of a cooking pan with strainer showing our new design.

FIG. 2 is a right side view thereof.

FIG. 3 is a left side view thereof.

FIG. 4 is an enlarged front view thereof.

FIG. 5 is an enlarged rear view thereof.

FIG. 6 is a top view thereof.

FIG. 7 is a bottom view thereof.

FIG. 8 is an exploded perspective view thereof, shown with the strainer unattached to the cooking pan for completeness of illustration.

FIG. 9 is an enlarged right view of the strainer portion, shown separately for ease of illustration; the left view being a mirror image thereof.

FIG. 10 is an enlarged front view of the strainer portion thereof.

FIG. 11 is an enlarged rear view of the strainer portion thereof;

FIG. 12 is an enlarged top view of the strainer portion thereof; and,

FIG. 13 is an enlarged bottom view of the strainer portion thereof.

1 Claim, 6 Drawing Sheets

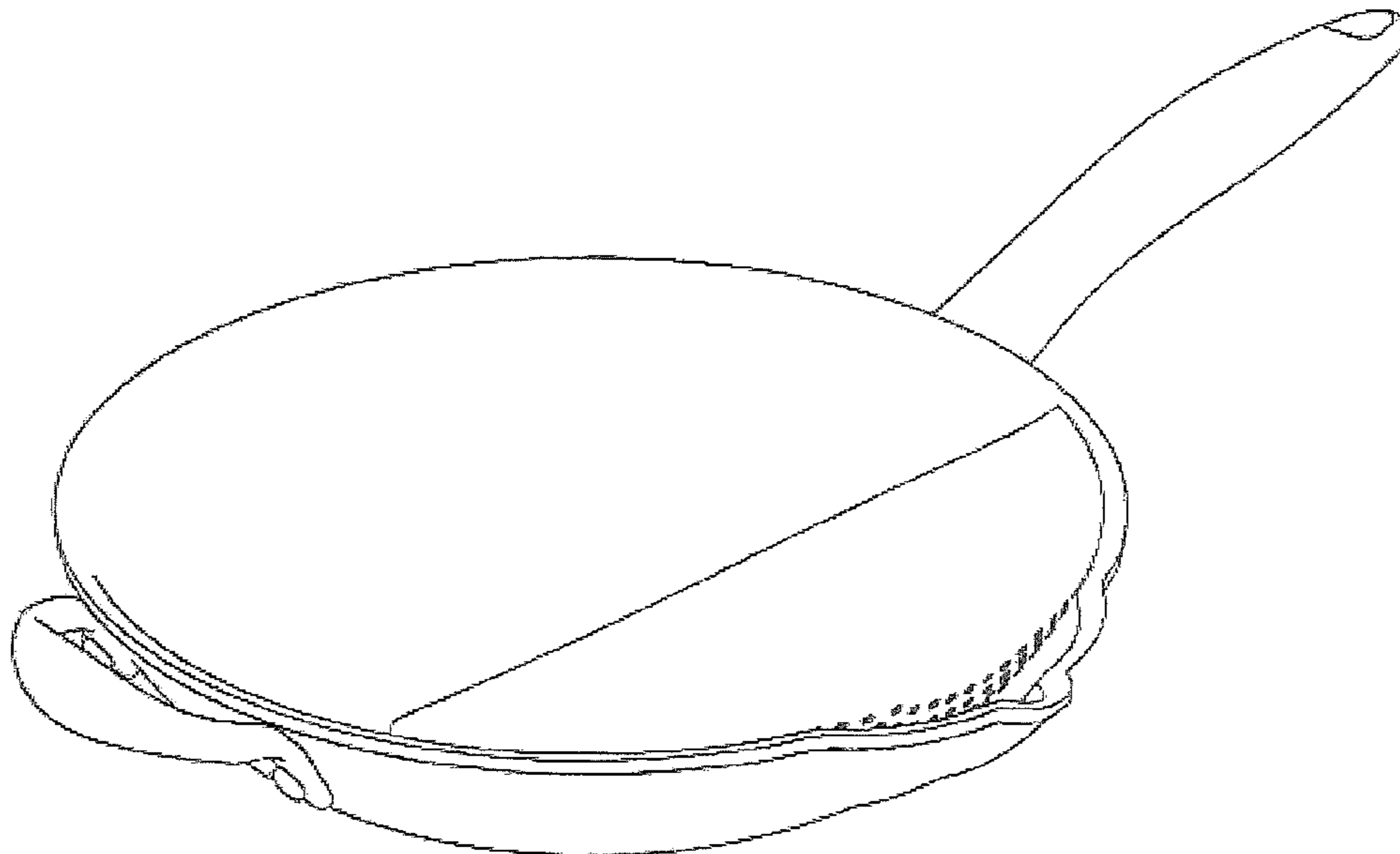

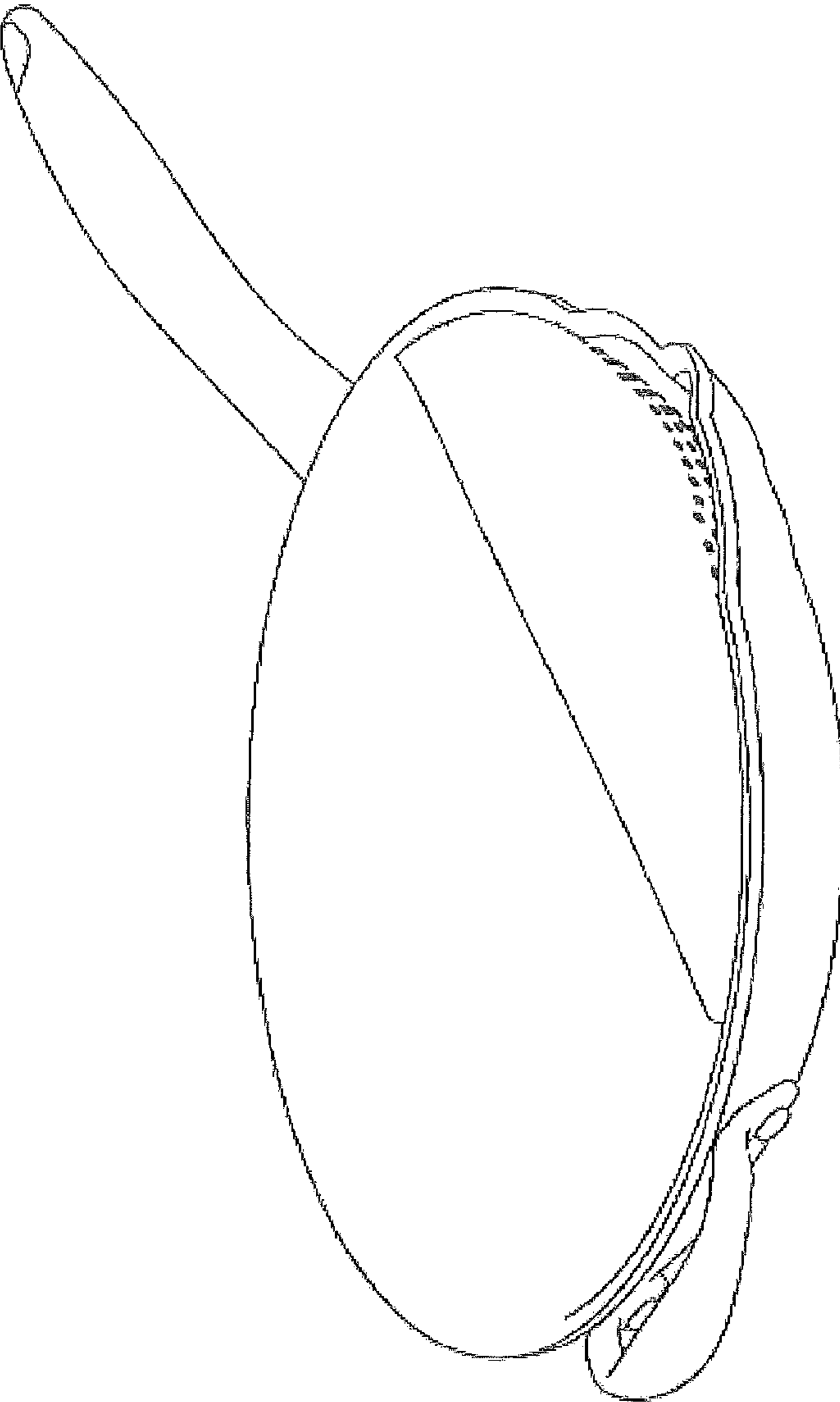

Fig. 1

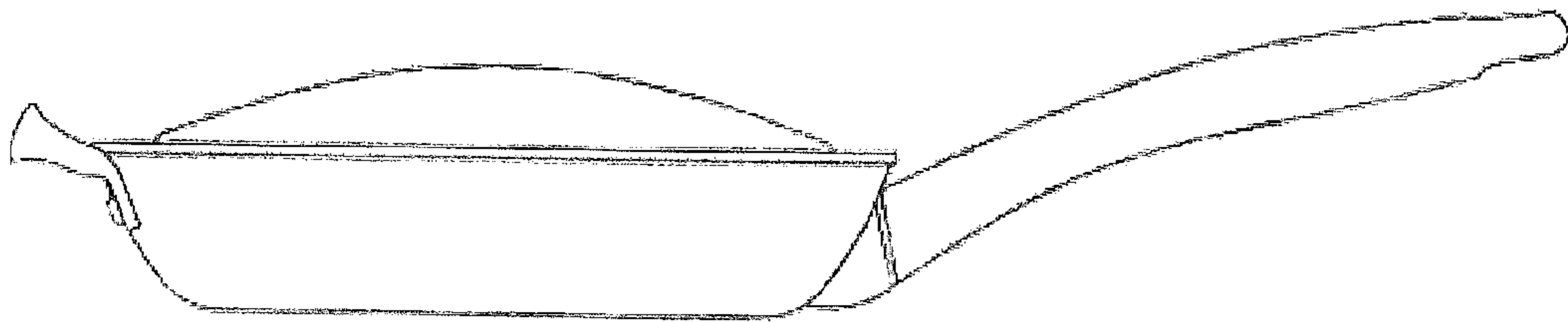

Fig. 2

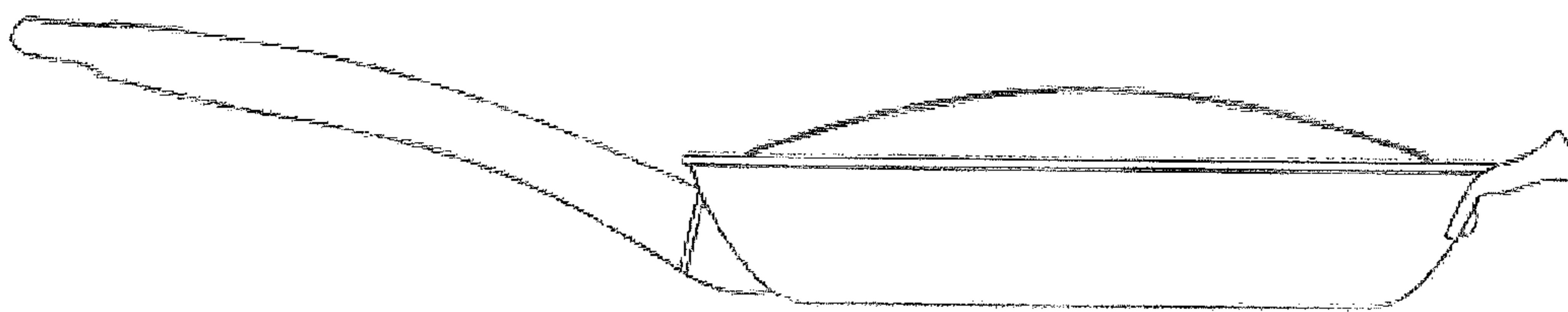

Fig. 3

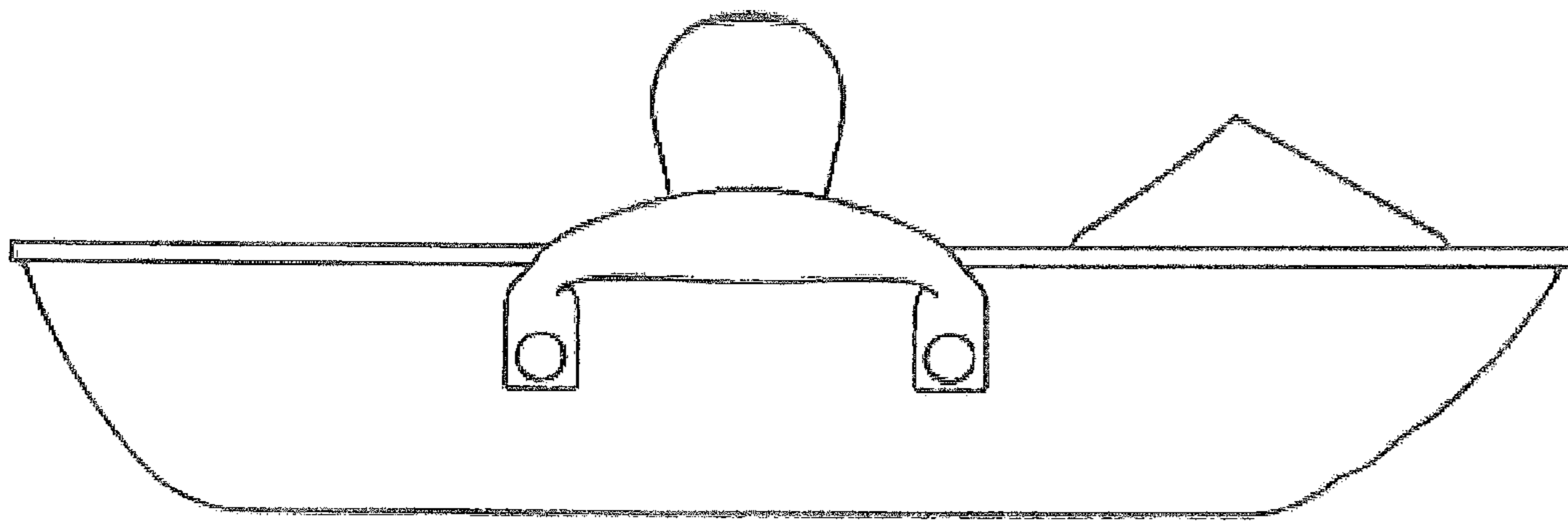

Fig. 4

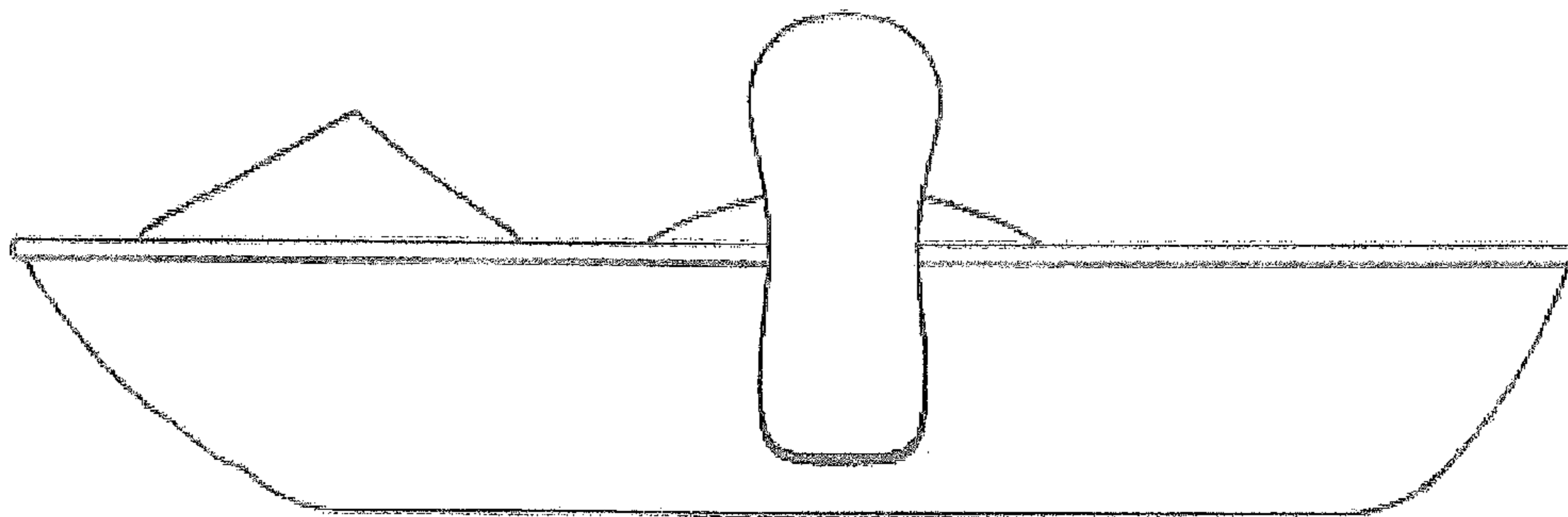

Fig. 5

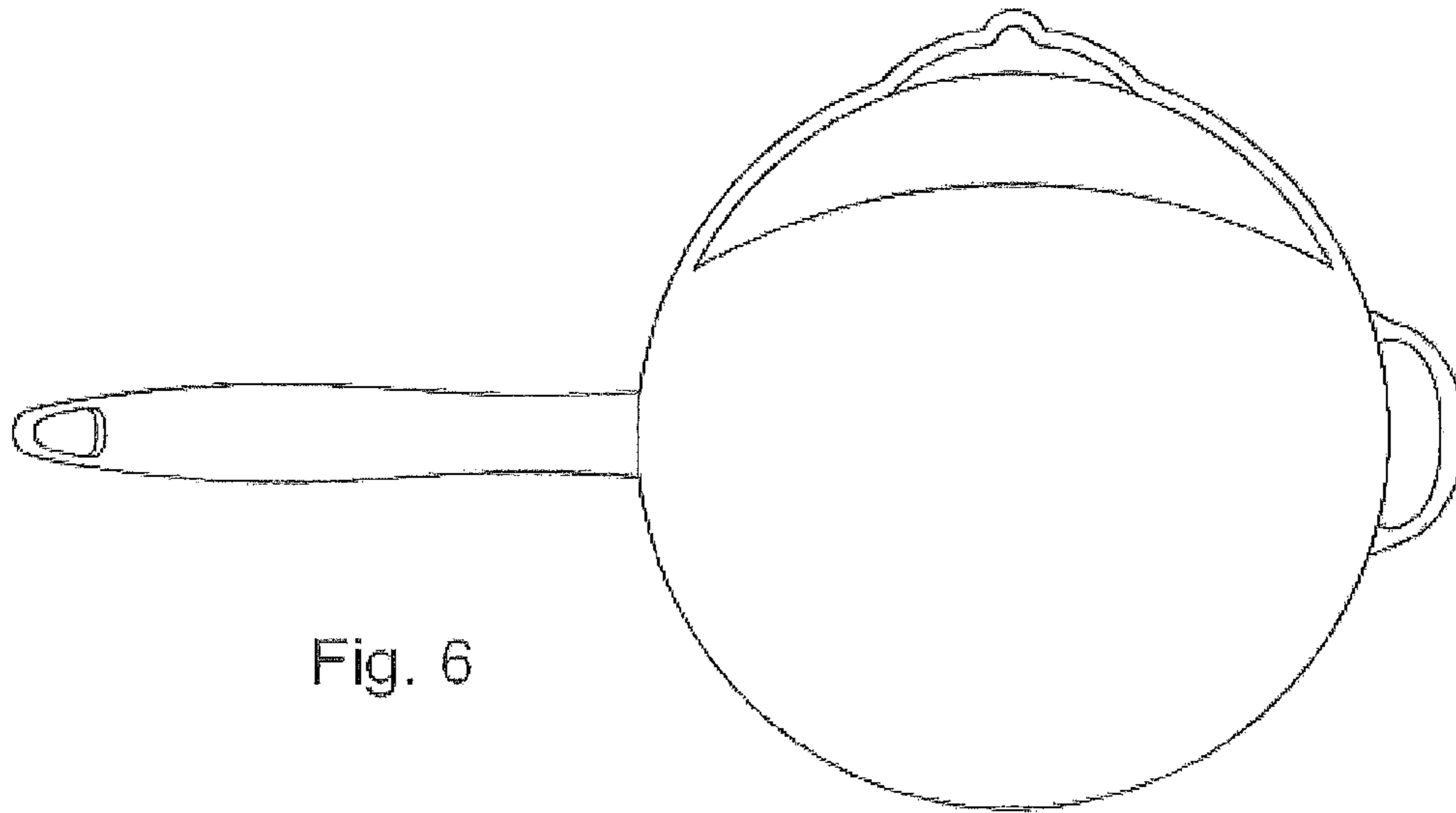

Fig. 6

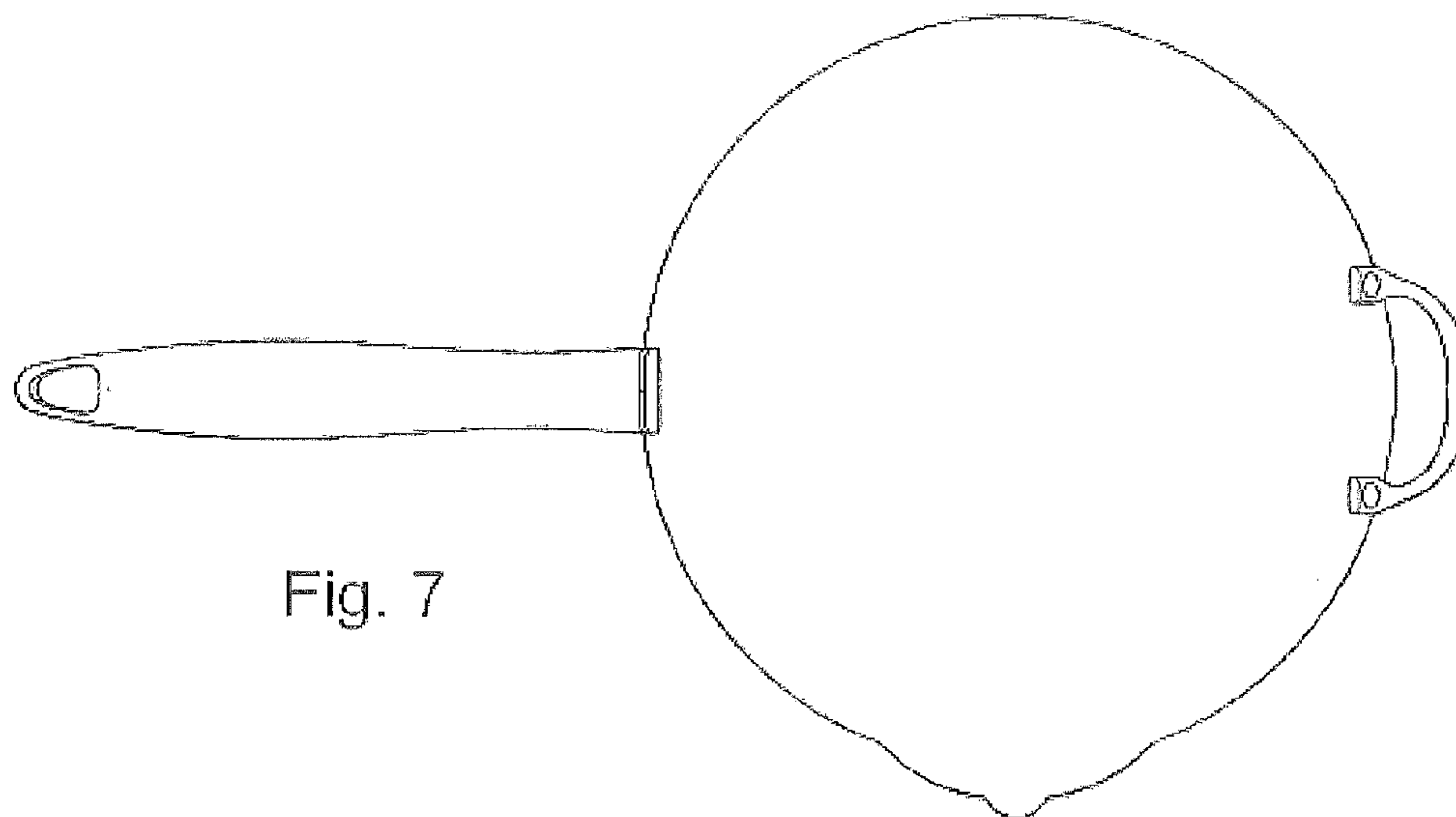

Fig. 7

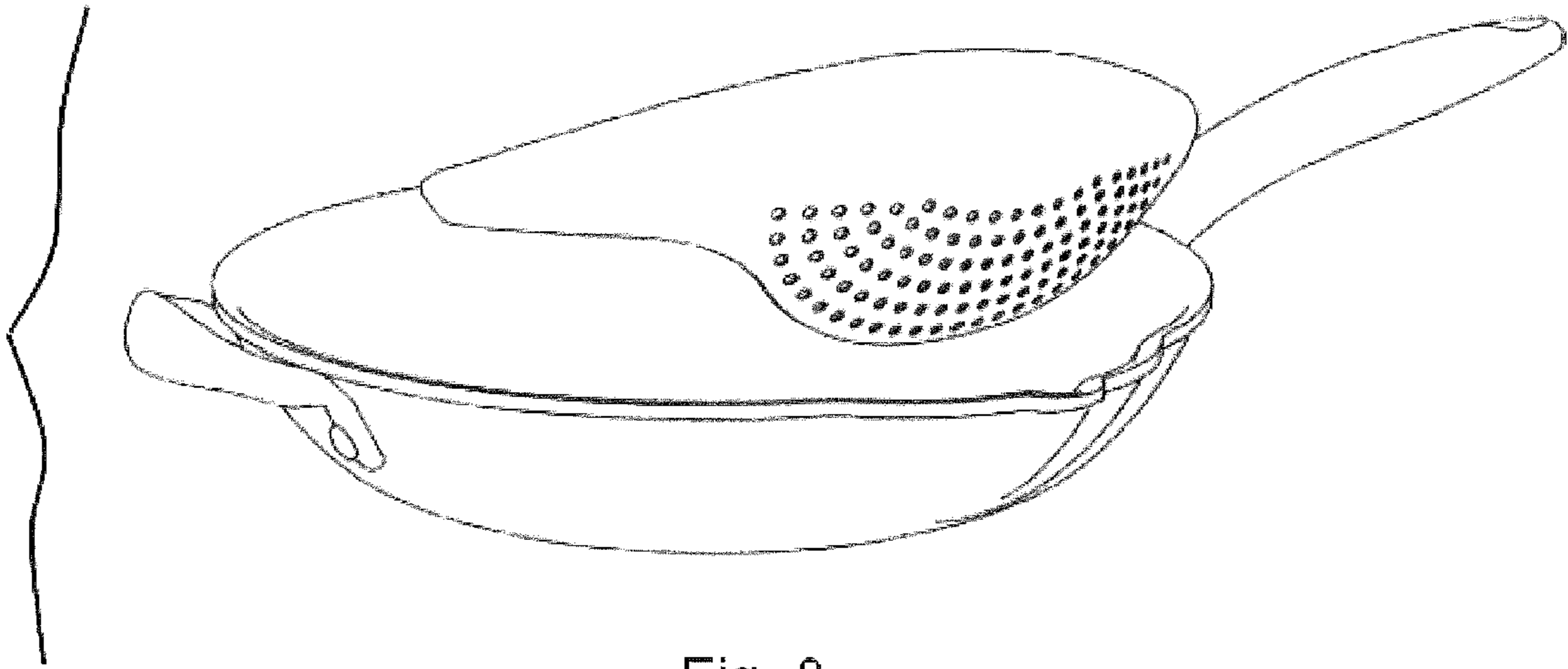

Fig. 8

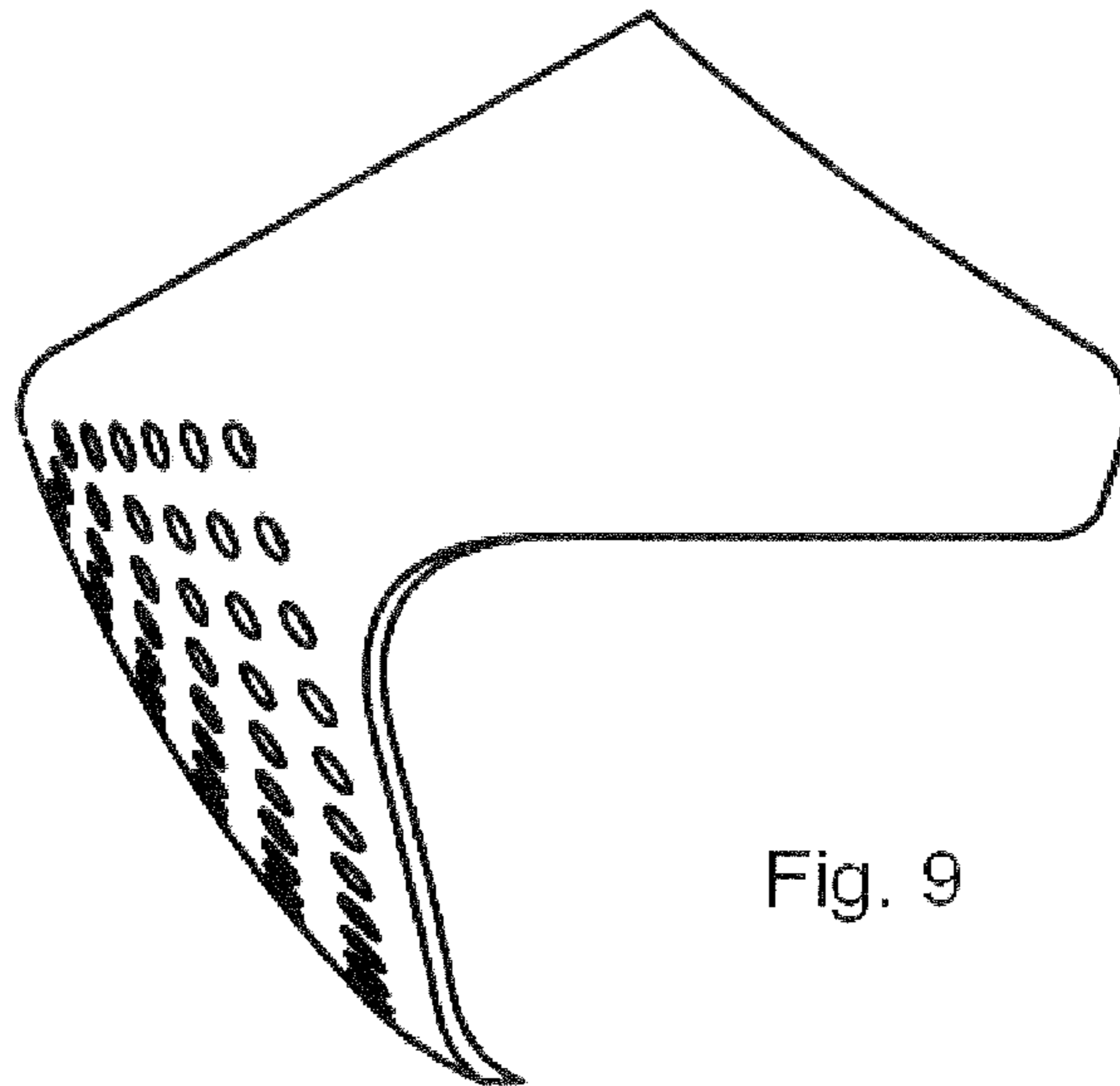

Fig. 9

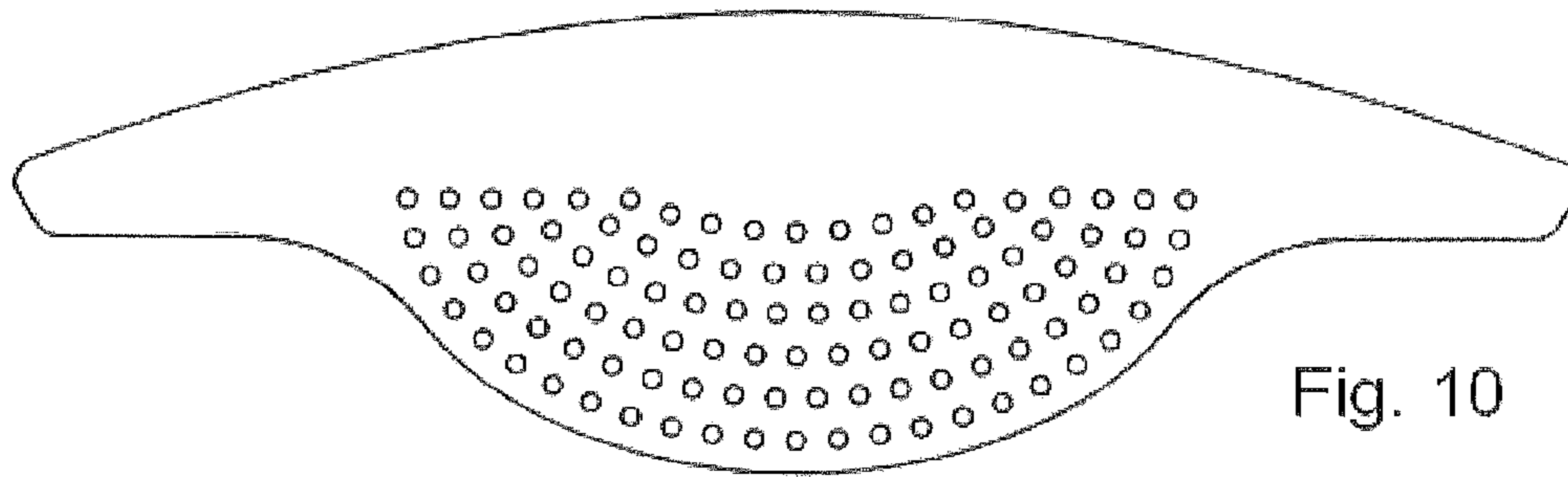

Fig. 10

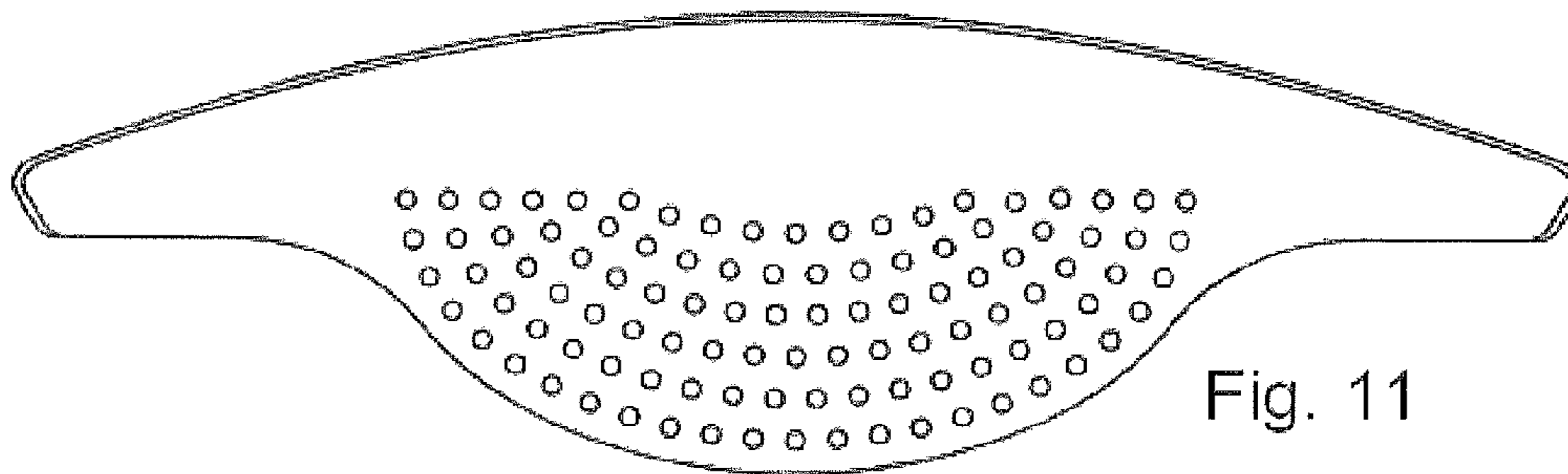

Fig. 11

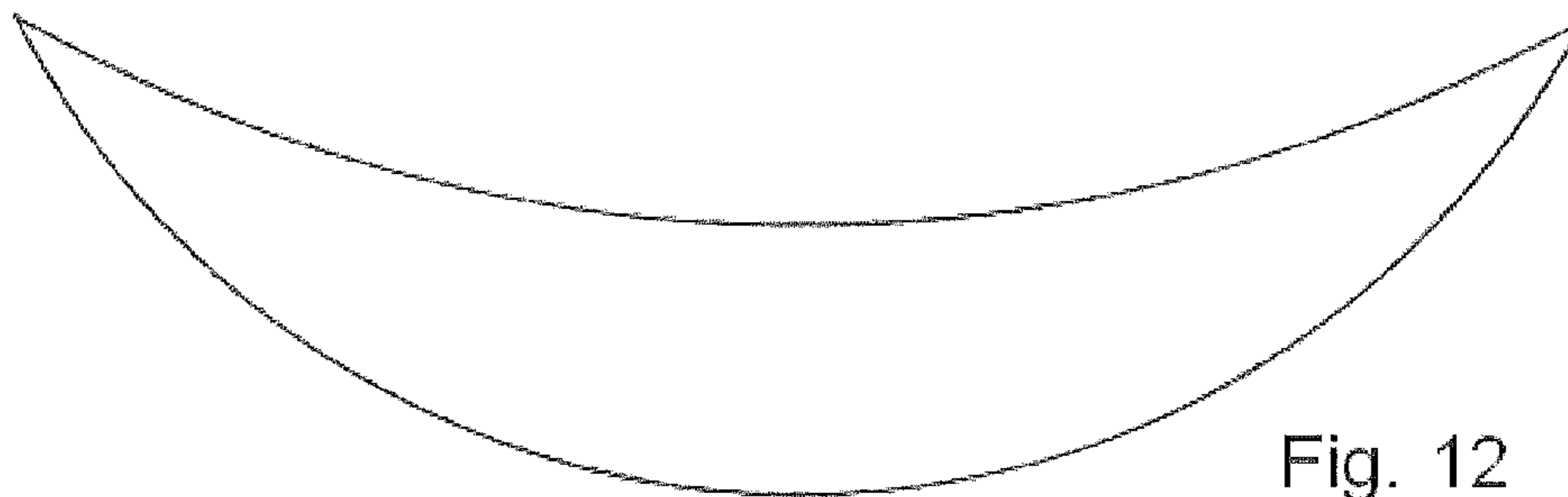

Fig. 12

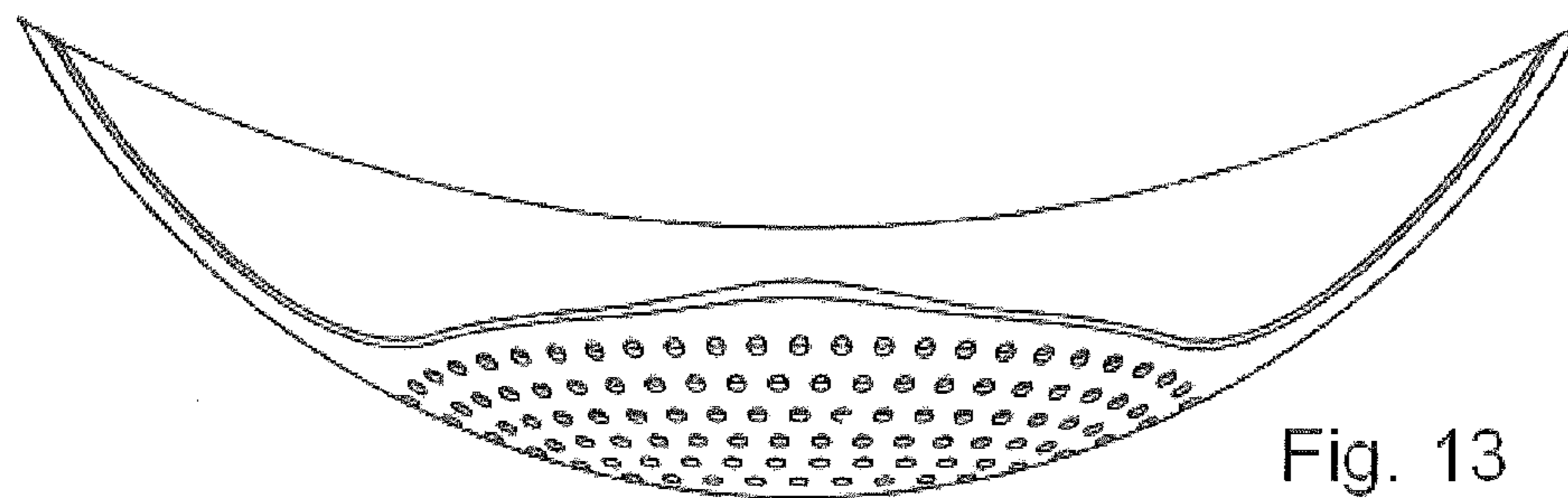

Fig. 13