



US00D656357S

(12) **United States Design Patent**
Enghard

(10) **Patent No.:** **US D656,357 S**
(45) **Date of Patent:** **** Mar. 27, 2012**

(54) **BEVERAGE SHAKER CUP**

FOREIGN PATENT DOCUMENTS

EM 001617416 1/2010
(Continued)

(76) Inventor: **Florian Enghard**, Sulzbach (DE)

OTHER PUBLICATIONS

Blender Bottle Photos, earliest Publication Date unknown.
(Continued)

(**) Term: **14 Years**

Primary Examiner — Marianne Pandozzi

(21) Appl. No.: **29/399,463**

(74) *Attorney, Agent, or Firm* — W. F. Fasse; W. G. Fasse

(22) Filed: **Aug. 15, 2011**

(57) **CLAIM**

(30) **Foreign Application Priority Data**

The ornamental design for a beverage shaker cup, as shown and described.

Feb. 15, 2011 (DE) 40 2011 000 820
Mar. 1, 2011 (DE) 40 2011 001 099

DESCRIPTION

(51) **LOC (9) Cl.** **07-01**

(52) **U.S. Cl.** **D7/300.1; D7/510; D7/511**

(58) **Field of Classification Search** D7/512,
D7/533, 536, 509, 523, 524, 529, 531, 532,
D7/300.1, 608, 510, 511; 220/495.08, 772,
220/763, 592.16, 592.17, 703; D9/431, 424
See application file for complete search history.

FIG. 1 is a bottom rear left perspective view of a beverage shaker cup showing my new design, the bottom rear right perspective view being a mirror image thereof; FIG. 2 is a right side elevational view, the left side elevational view being a mirror image thereof; FIG. 3 is a front elevational view thereof; FIG. 4 is a top plan view of both embodiments; FIG. 5 is a rear elevational view thereof; FIG. 6 is a front top left perspective view of a beverage shaker cup of both embodiments with the cup portion removed, leaving only the lid, for ease of illustration; FIG. 7 is a rear top left perspective view thereof; FIG. 8 is a rear left perspective view thereof; FIG. 9 is a top front right perspective view thereof with the flip lid also removed for ease of illustration; FIG. 10 is another bottom rear left perspective view of FIG. 1; FIG. 11 is a bottom rear left perspective view of beverage shaker cup showing a second embodiment of my new design; FIG. 12 is a rear elevational view thereof; and, FIG. 13 is a left side elevational view thereof, the right side being a mirror image thereof.

(56) **References Cited**

U.S. PATENT DOCUMENTS

3,760,972 A * 9/1973 McKirnan 220/592.16
3,820,692 A * 6/1974 Swett et al. 222/547
D421,547 S * 3/2000 Demers D7/510
D429,118 S * 8/2000 Hurlbut D7/608
D453,445 S * 2/2002 Sokolski et al. D7/510
D510,235 S * 10/2005 Sorensen D7/510
D513,916 S 1/2006 Namee
D549,048 S * 8/2007 Duke et al. D7/510
D552,929 S * 10/2007 de Groote D7/510
D573,839 S * 7/2008 Sun D7/510
D580,227 S * 11/2008 Roth et al. D7/510
D632,133 S * 2/2011 Giraud et al. D7/510
D632,918 S * 2/2011 Gordon D7/300.1
D634,160 S * 3/2011 Cetera D7/510

(Continued)

1 Claim, 4 Drawing Sheets

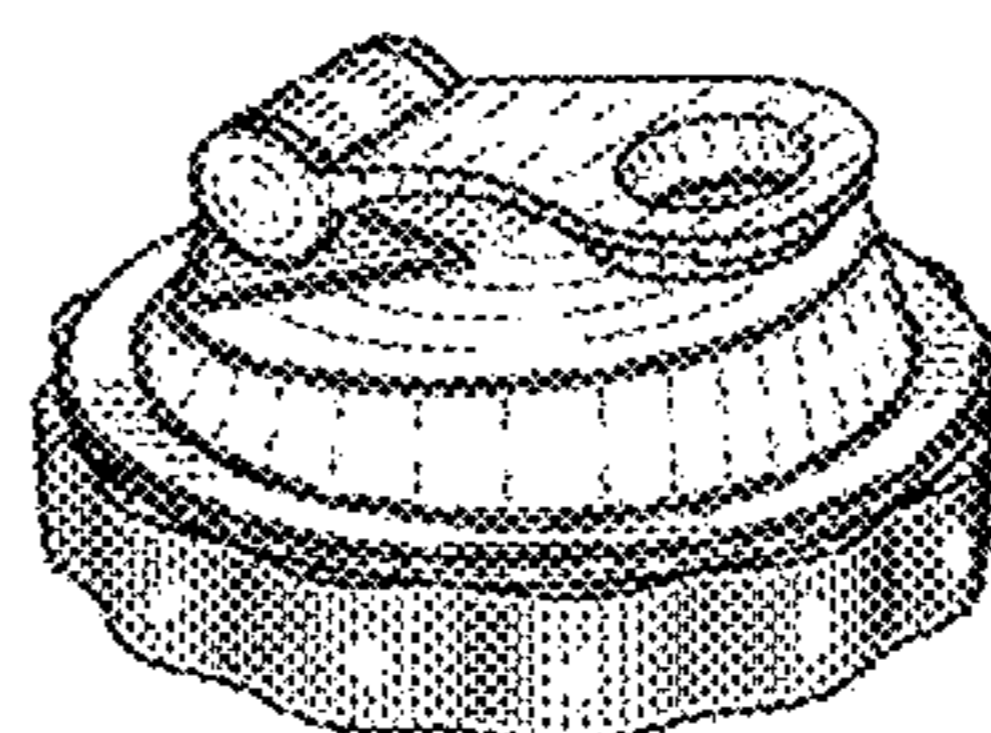
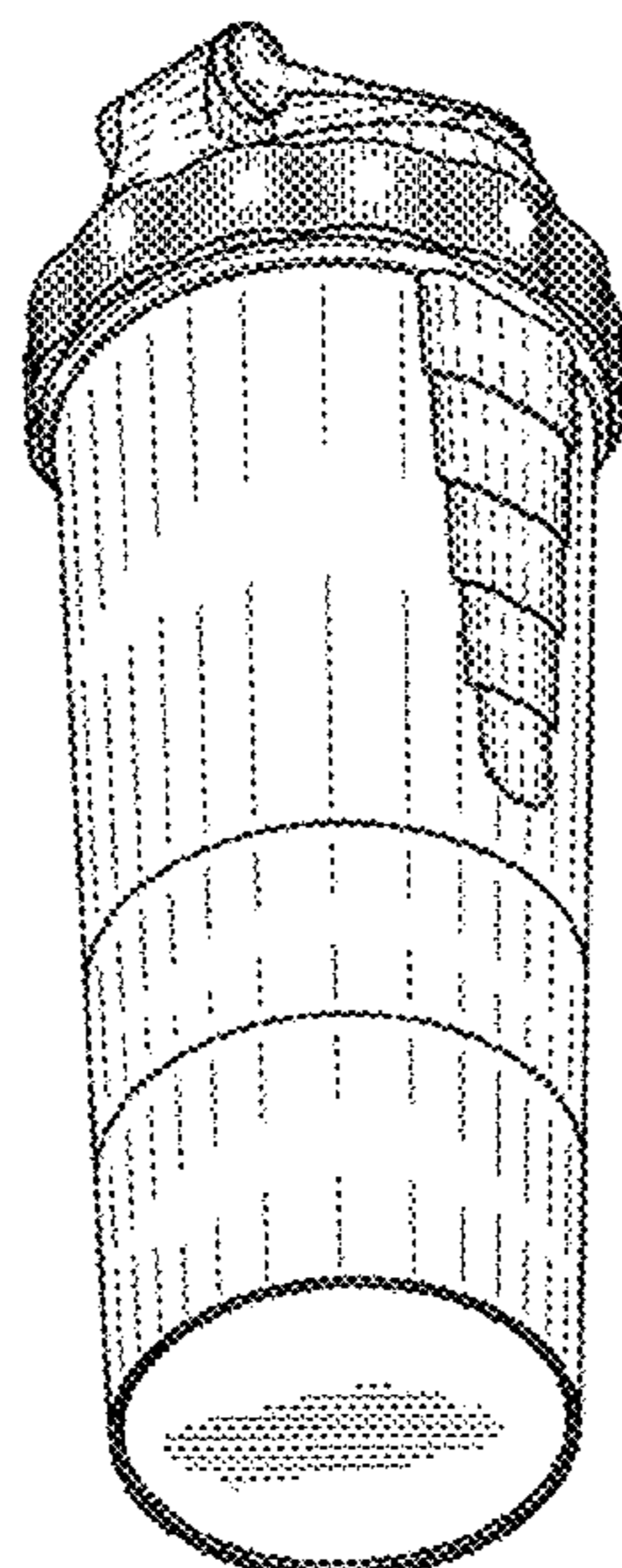

US D656,357 S

Page 2

U.S. PATENT DOCUMENTS

D644,065 S * 8/2011 Llerena D7/510
D646,919 S * 10/2011 Nilsson D7/300.1

FOREIGN PATENT DOCUMENTS

EM 001753609 9/2010
GB 2 454 759 5/2009

OTHER PUBLICATIONS

Trig Mixer Photo, earliest Publication Date unknown.

Smart Shake Photos, earliest Publication Date unknown.

Body Attack Sports Nutrition Photo, earliest Publication Date unknown.

Blender Bottle Photos, earliest Publication Date unknown.

Smart Shake Marketing Flyer, earliest Publication Date unknown, 2 pg.

Fit&fresh CleanTek Shaker Bottle Photos, earliest Publication Date unknown.

* cited by examiner

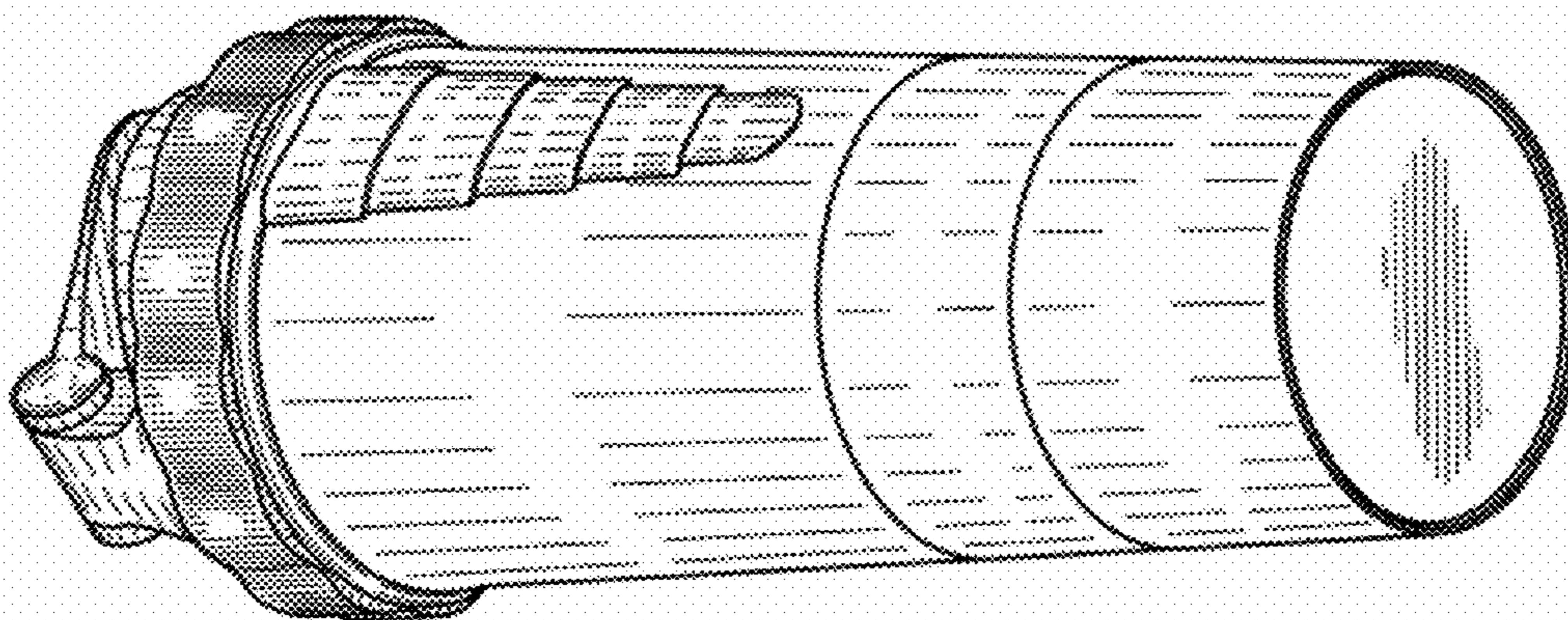

FIG. 1

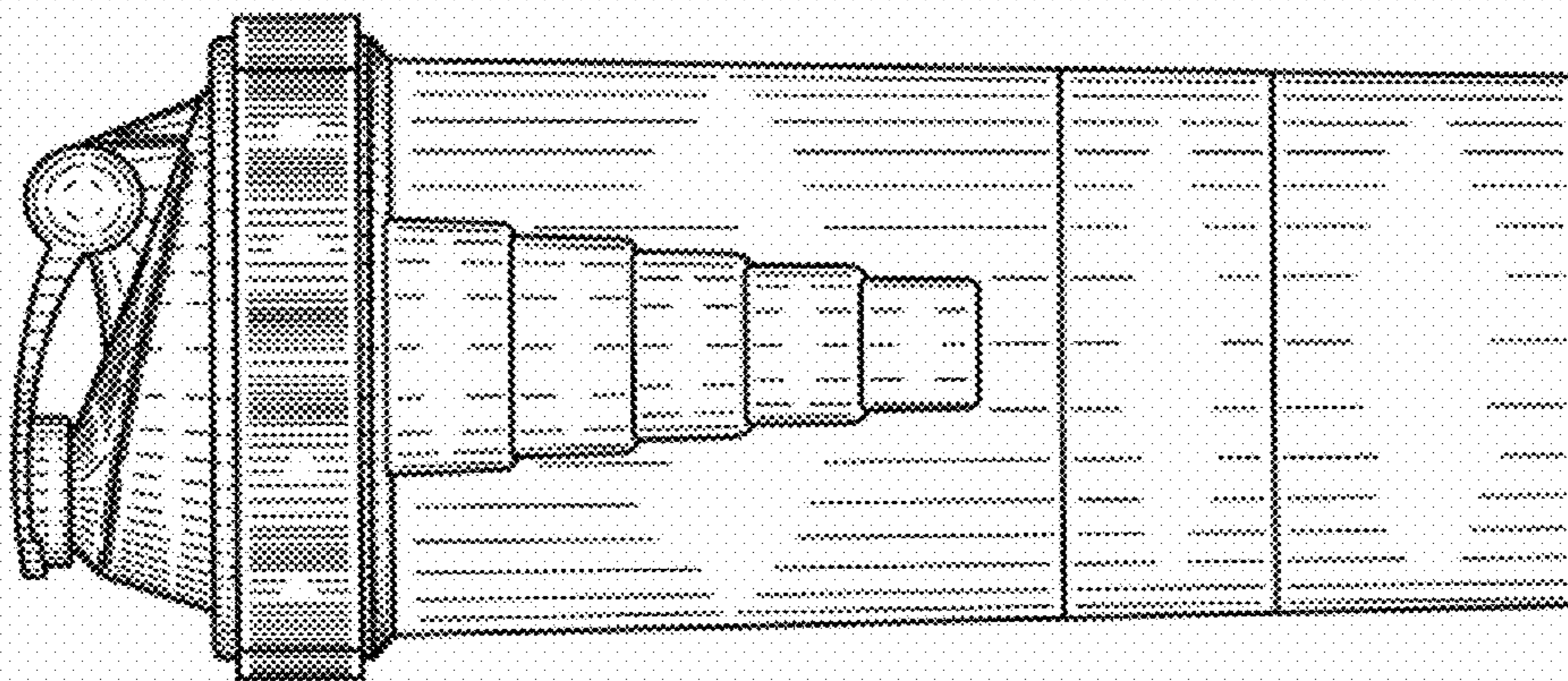

FIG. 2

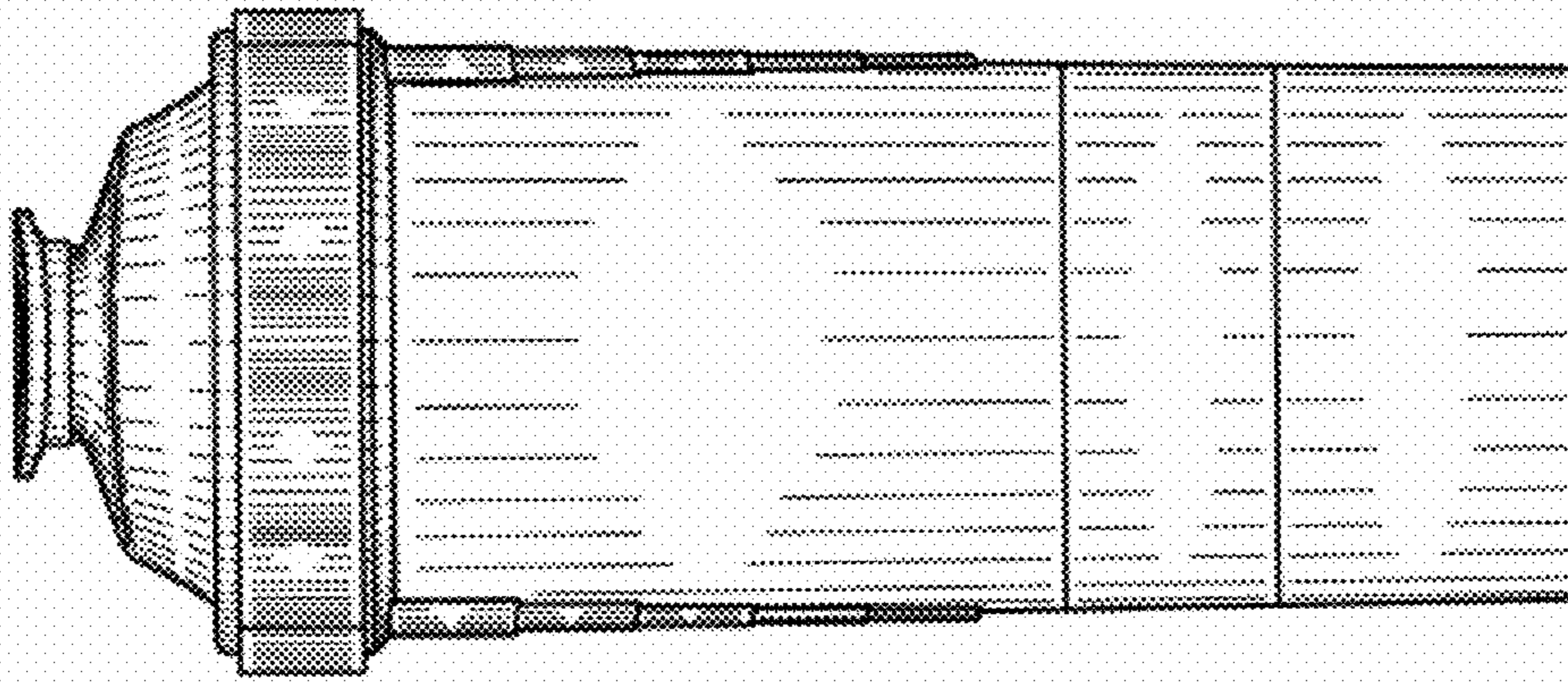

FIG. 3

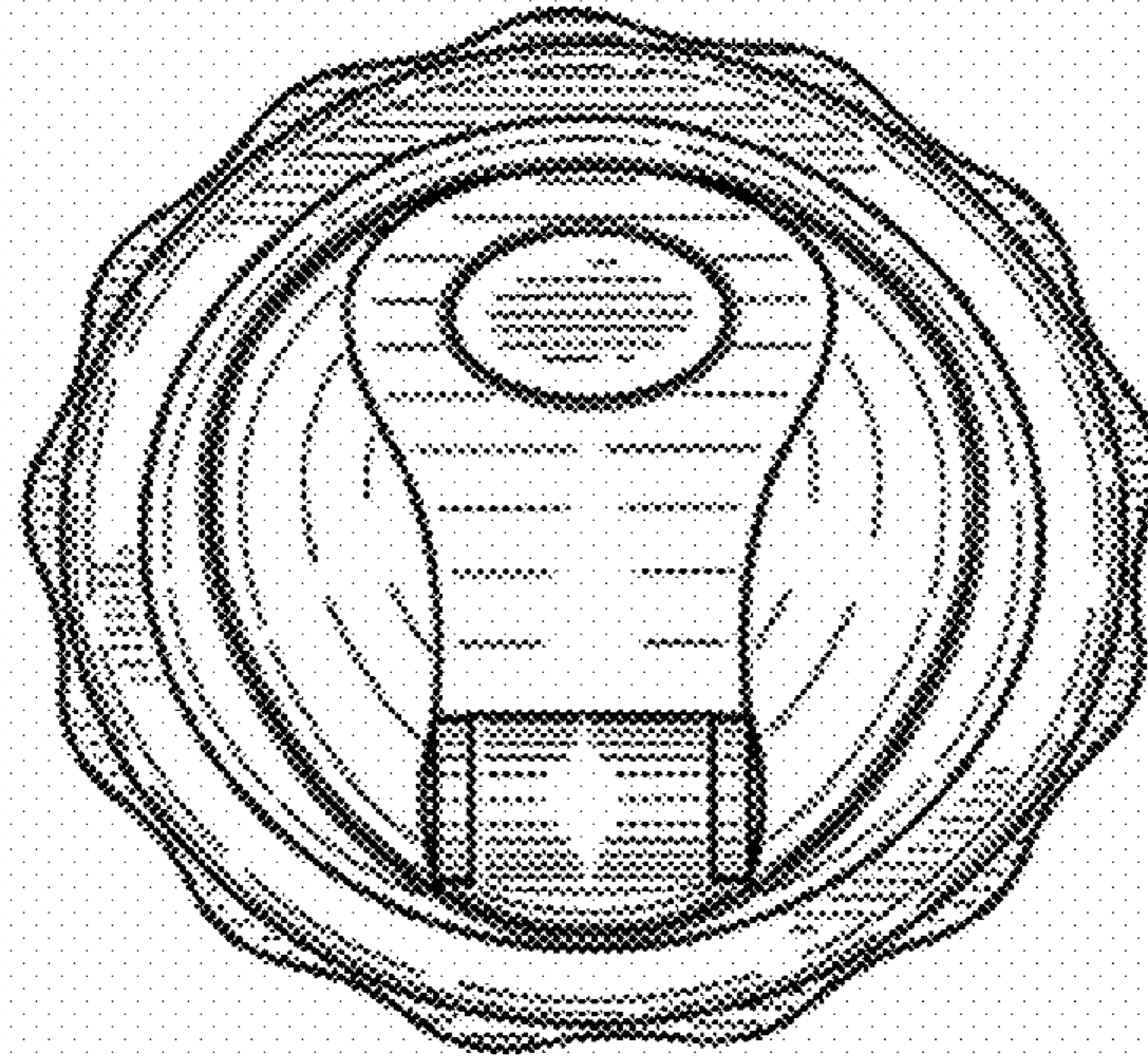

FIG. 4

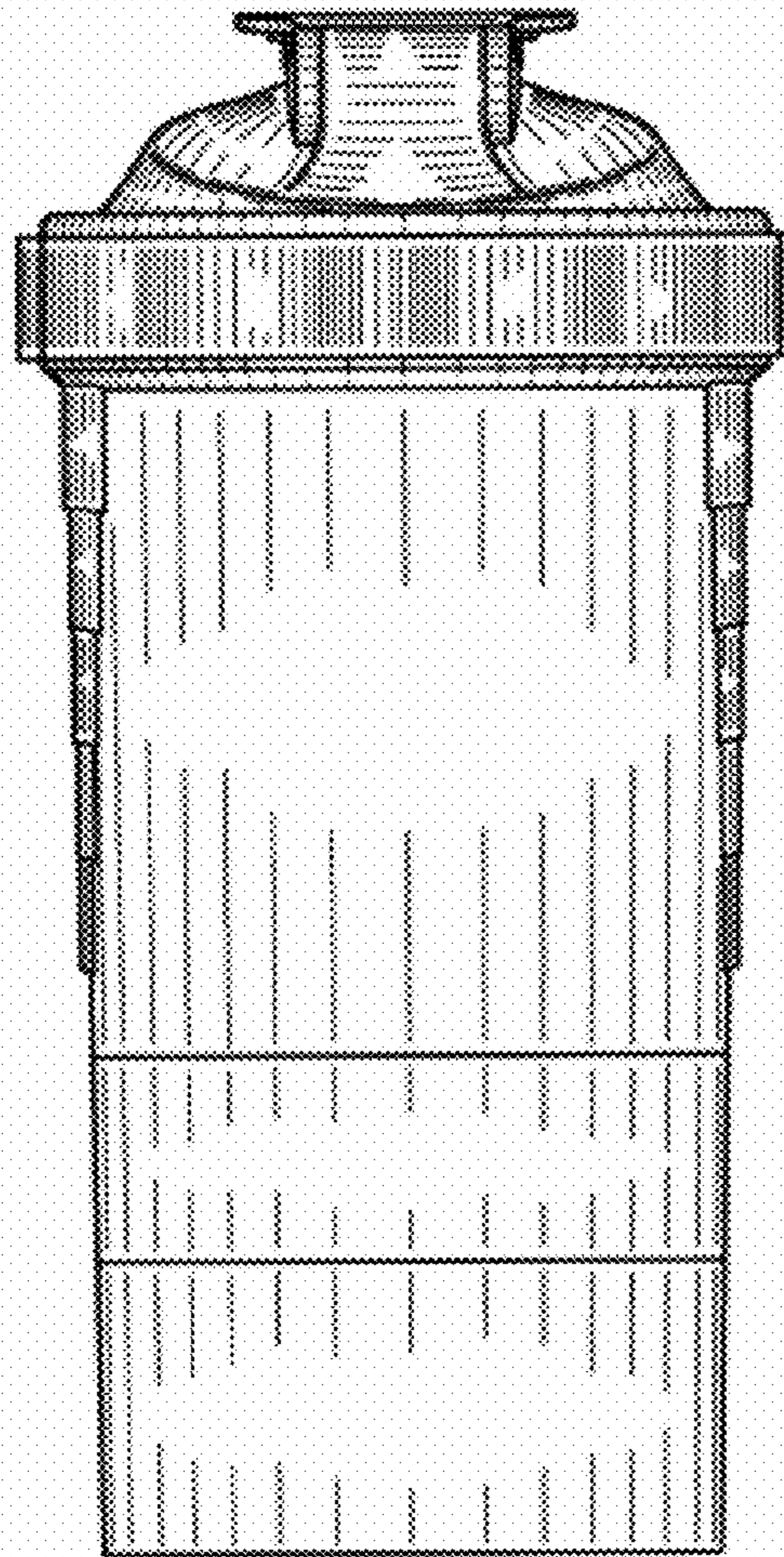

FIG. 5

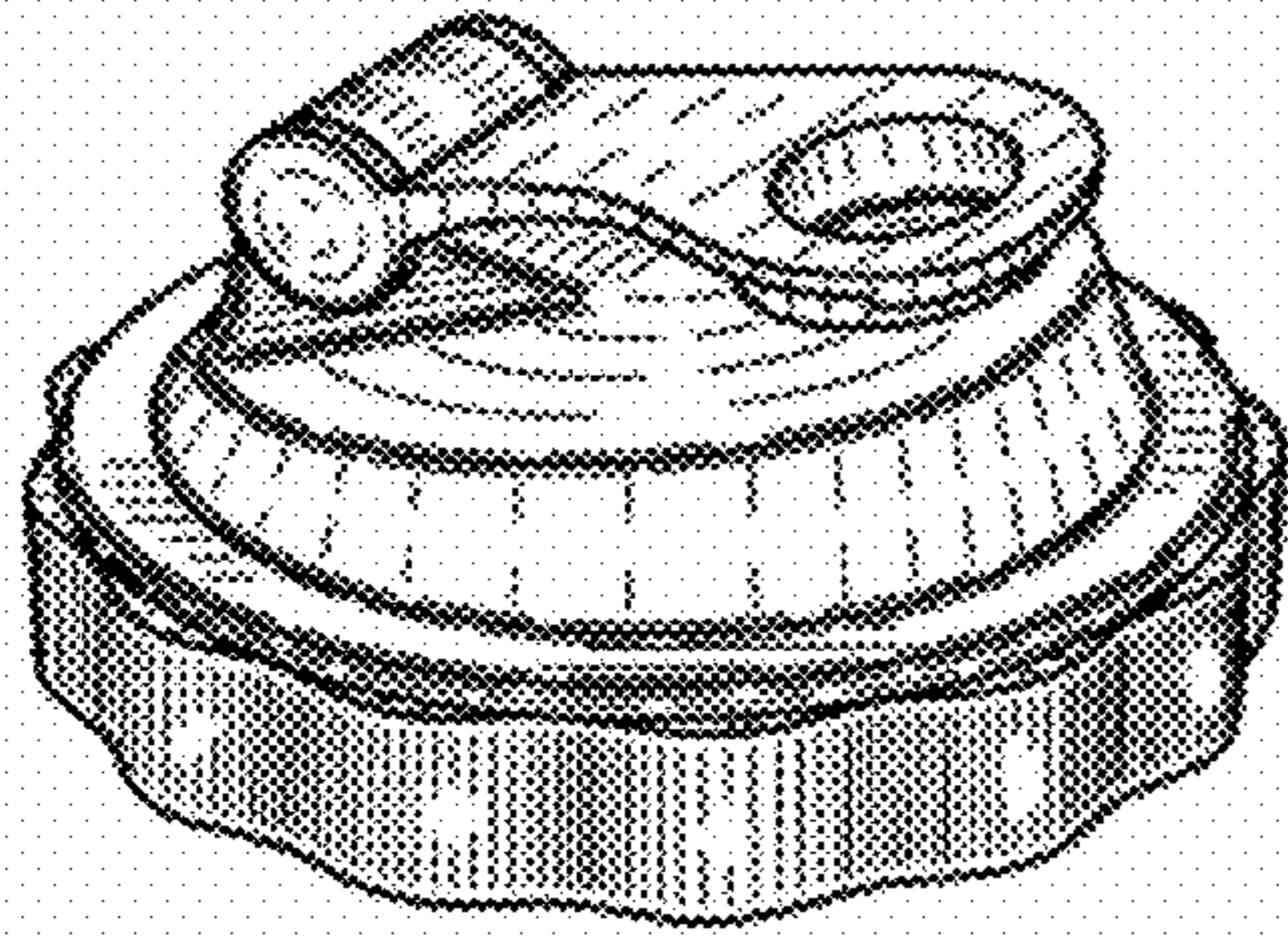

FIG. 6

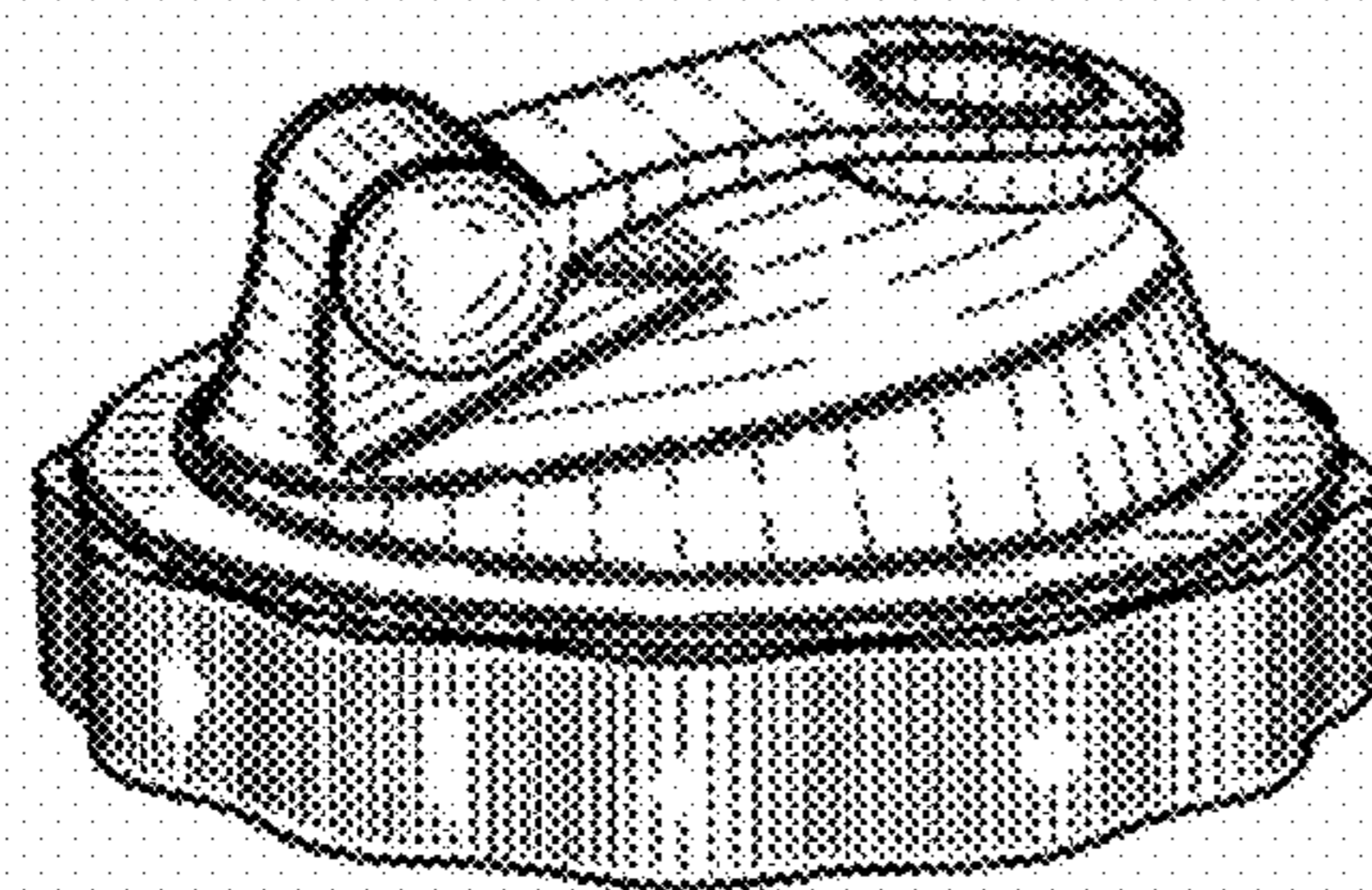

FIG. 7

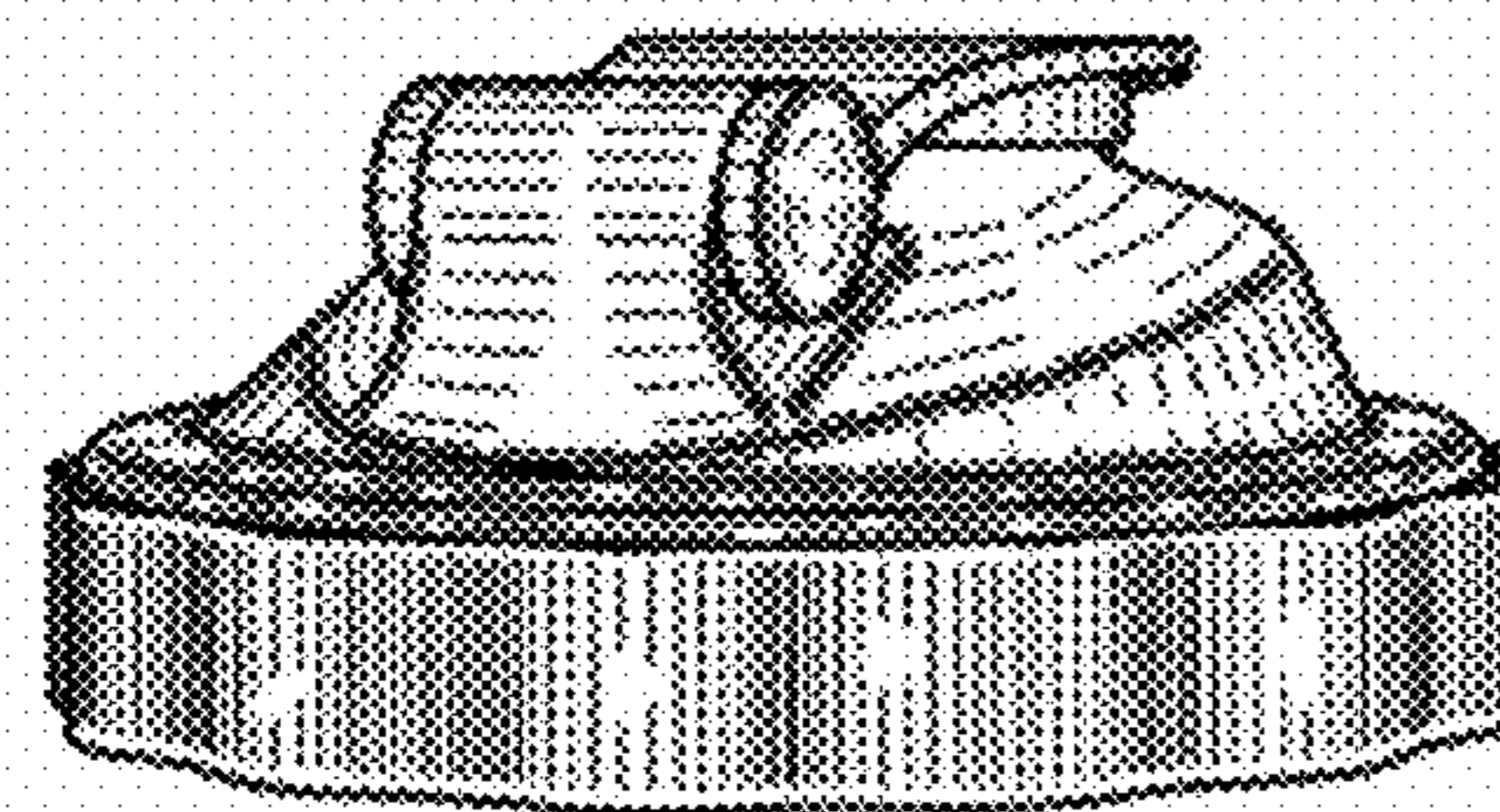

FIG. 8

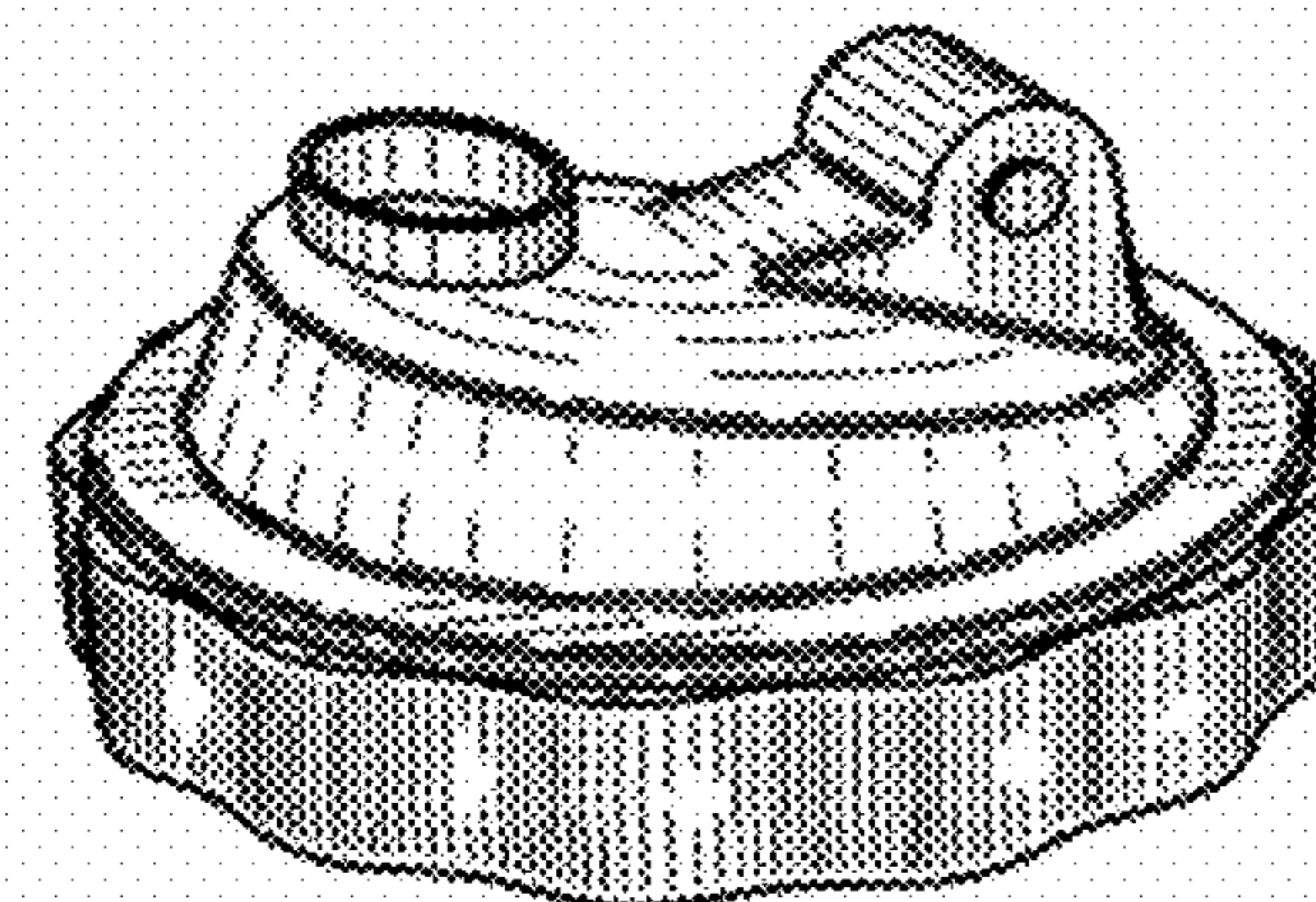

FIG. 9

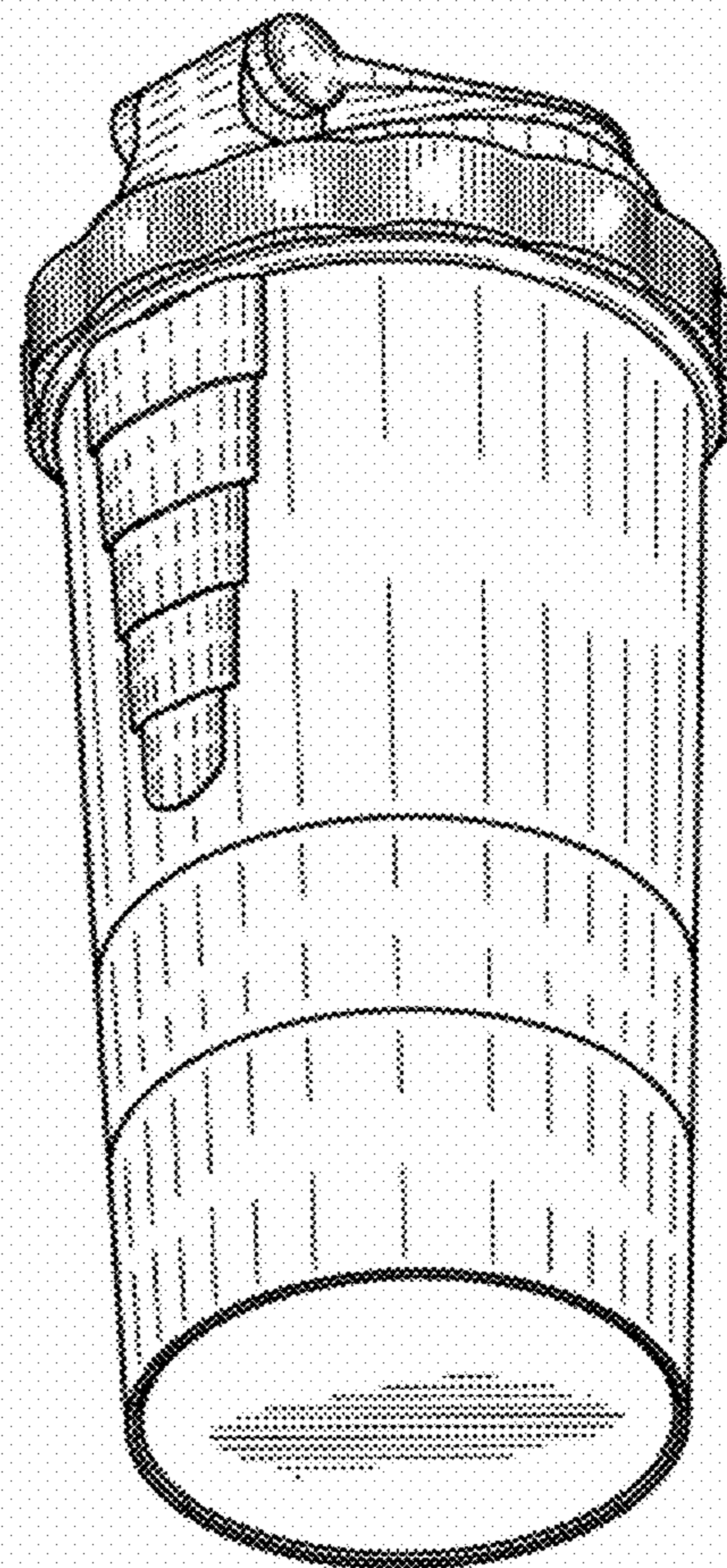

FIG. 10

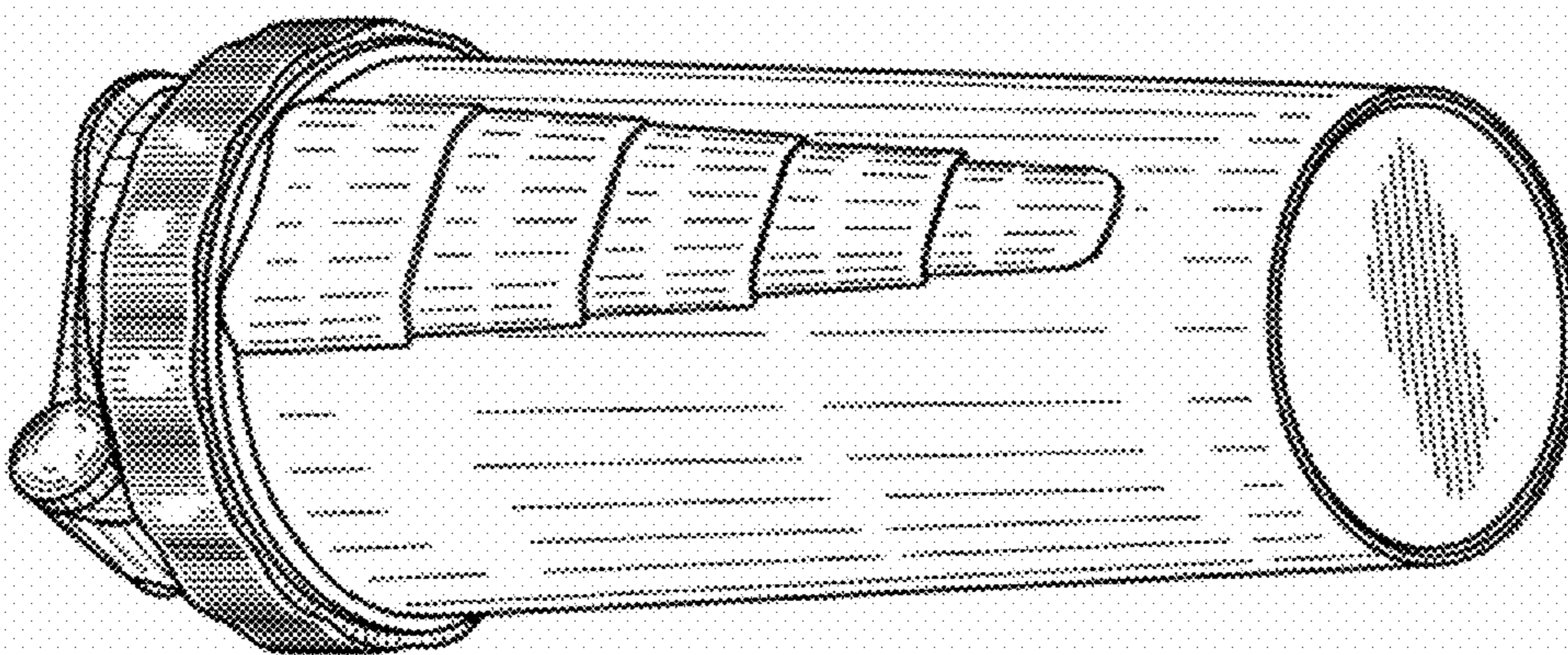

FIG. 11

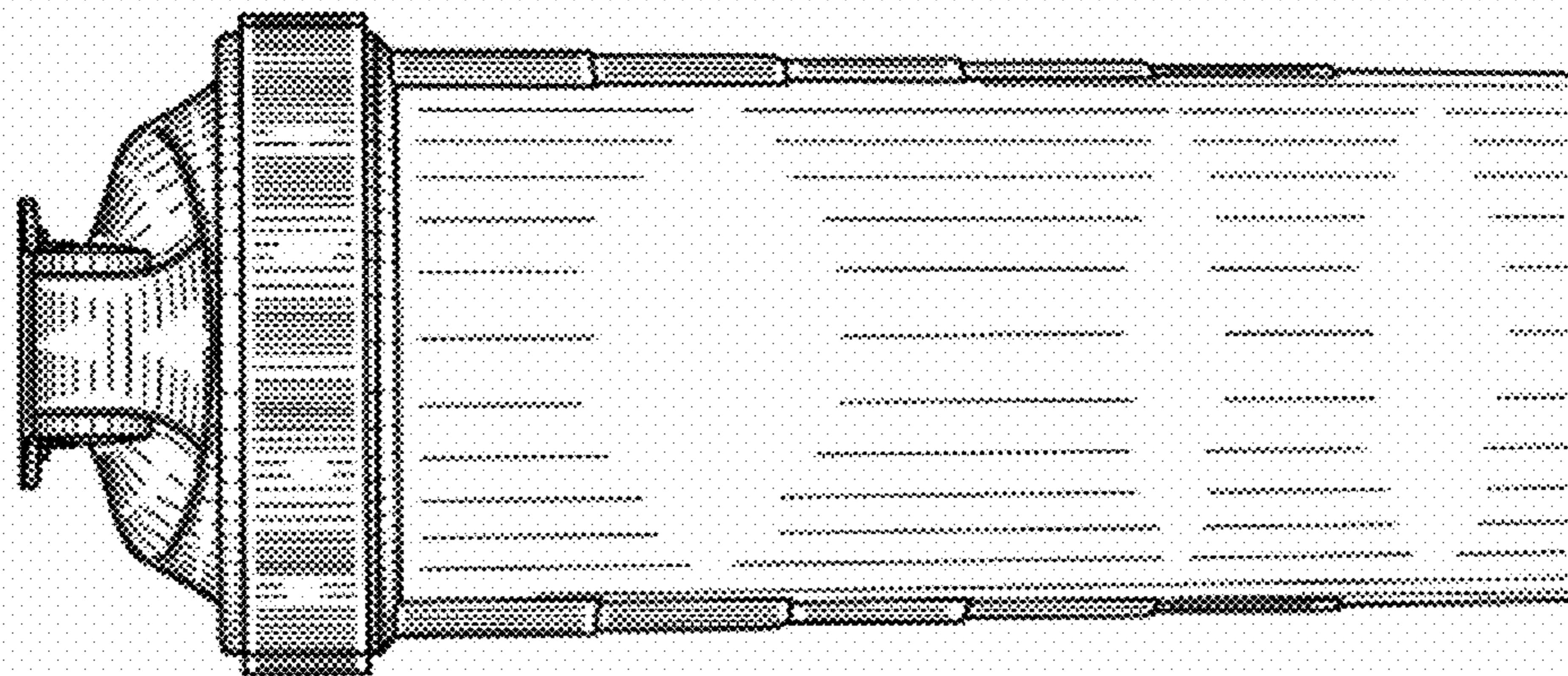

FIG. 12

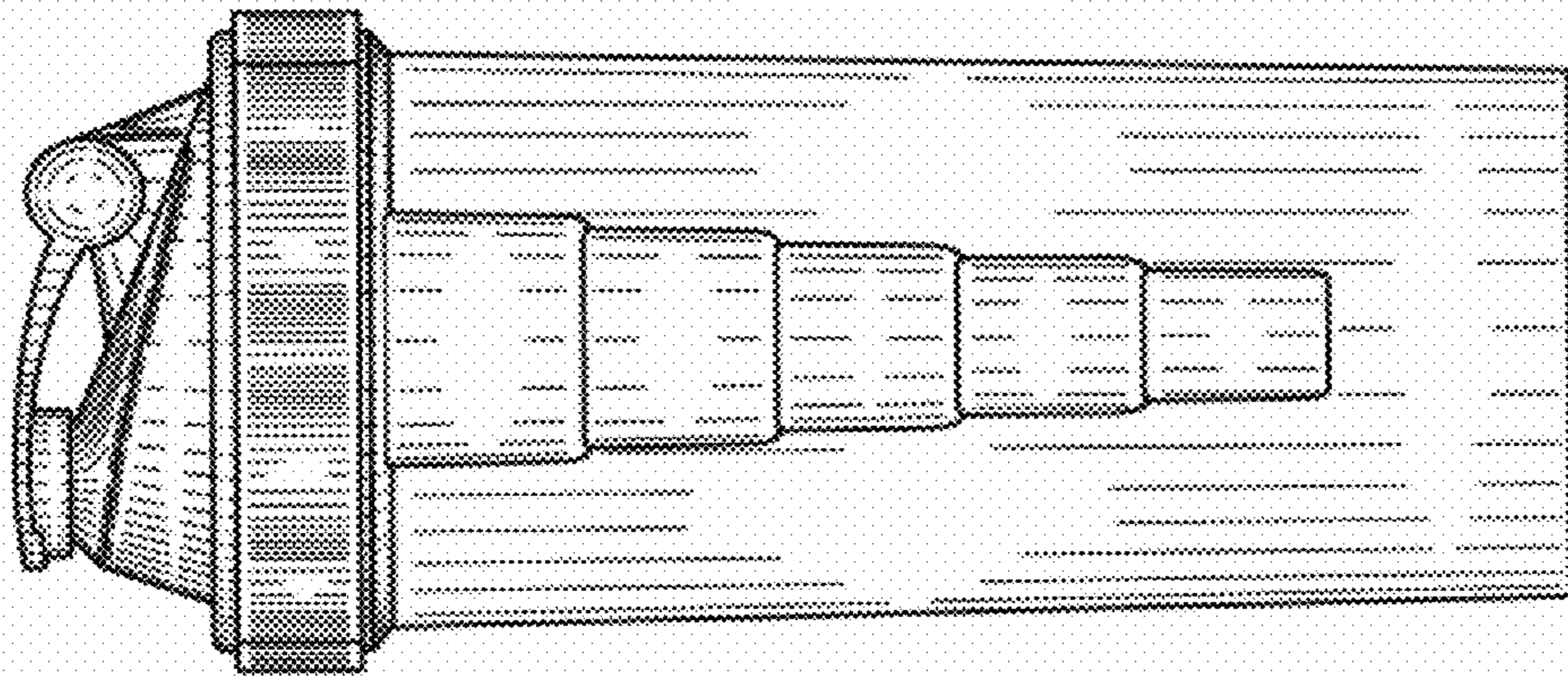

FIG. 13