



US00D656229S

(12) **United States Design Patent**
Wang et al.

(10) **Patent No.:** **US D656,229 S**

(45) **Date of Patent:** **** Mar. 20, 2012**

(54) **TOILET**

(75) Inventors: **Yanchun Wang**, Ballasalla (IM); **Robert William Stimpson**, Douglas (IM)

(73) Assignee: **DLP Limited**, Douglas (IM)

(**) Term: **14 Years**

(21) Appl. No.: **29/384,196**

(22) Filed: **Jan. 27, 2011**

(30) **Foreign Application Priority Data**

Aug. 5, 2010 (EM) 001740770

(51) **LOC (9) Cl.** **23-02**

(52) **U.S. Cl.** **D23/295**

(58) **Field of Classification Search** D23/295,
D23/301, 303, 309, 313; 4/300, 353, 420,
4/DIG. 15

See application file for complete search history.

(56) **References Cited**

U.S. PATENT DOCUMENTS

D311,057 S *	10/1990	Stairs, Jr.	D23/295
D471,621 S *	3/2003	Bennie	D23/313
D472,310 S *	3/2003	Kawamura	D23/301
D483,448 S *	12/2003	Ruxchaivan	D23/295
D505,190 S *	5/2005	Cutler	D23/295
D507,335 S *	7/2005	Gordon	D23/295
D531,714 S *	11/2006	Soulier	D23/313

* cited by examiner

Primary Examiner — Robert Delehanty

(74) *Attorney, Agent, or Firm* — Pyprus Pte Ltd

(57) **CLAIM**

We claim the ornamental design for a toilet, as shown and described.

DESCRIPTION

FIG. 1 is a perspective view from above, front and to one side of a first embodiment of a toilet, showing our new design; FIG. 2 is a perspective view from above, rear and to one side of the toilet, as shown in FIG. 1; FIG. 3 is a top plan view of the toilet, as shown in FIG. 1; FIG. 4 is a right view of the toilet, as shown in FIG. 1; FIG. 5 is a left side view of the toilet, as shown in FIG. 1; FIG. 6 is a front side view of the toilet, as shown in FIG. 1; and FIG. 7 is a rear side view of the toilet, as shown in FIG. 1; FIG. 8 is a perspective view from above, front and to one side of a second embodiment of a toilet, showing our new design; FIG. 9 is a perspective view from above, rear and to one side of the toilet, as shown in FIG. 8; FIG. 10 is a top plan view of the toilet, as shown in FIG. 8; FIG. 11 is a right view of the toilet, as shown in FIG. 8; FIG. 12 is a left side view of the toilet, as shown in FIG. 8; FIG. 13 is a front side view of the toilet, as shown in FIG. 8; and, FIG. 14 is a rear side view of the toilet, as shown in FIG. 8.

1 Claim, 14 Drawing Sheets

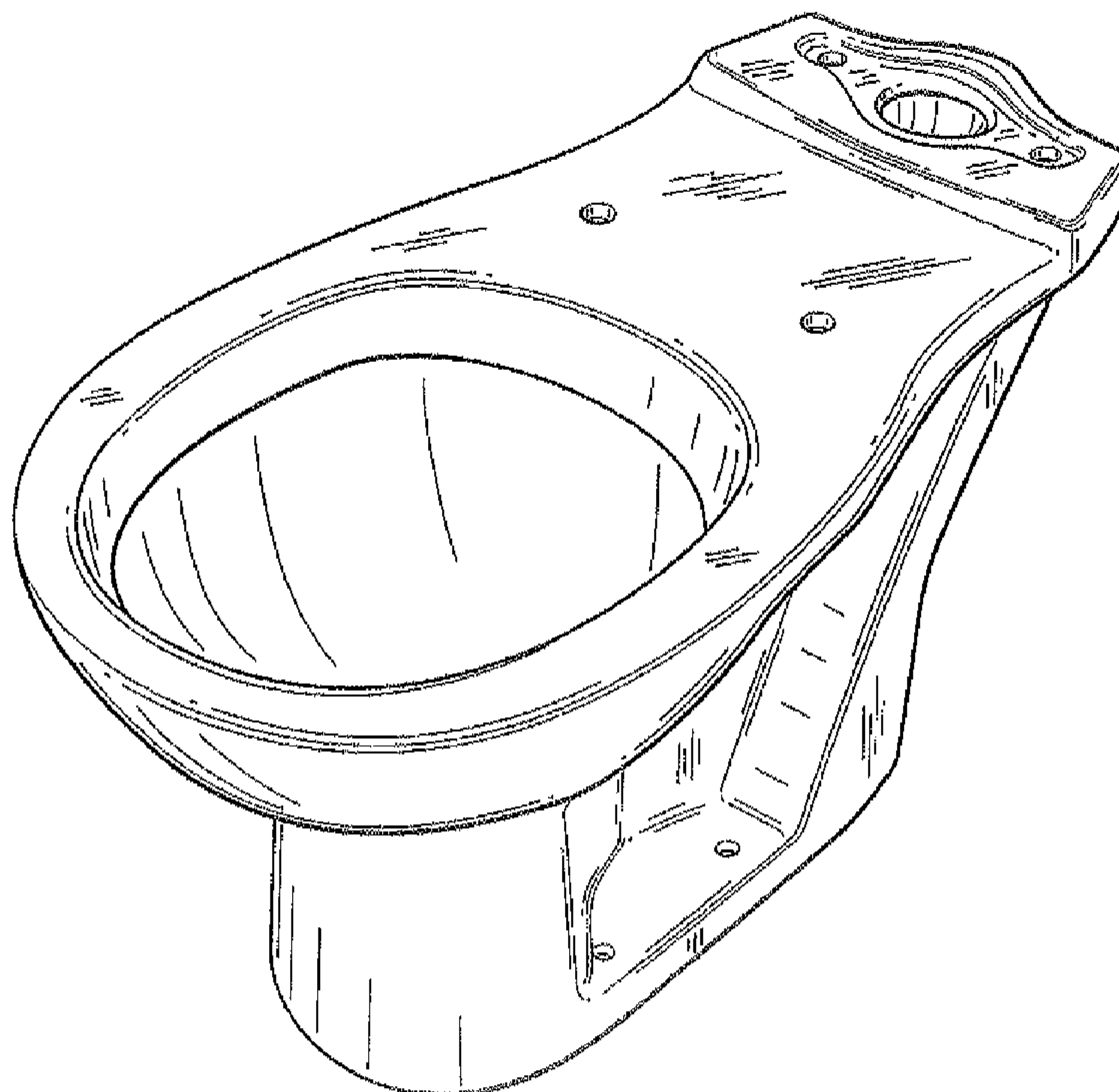

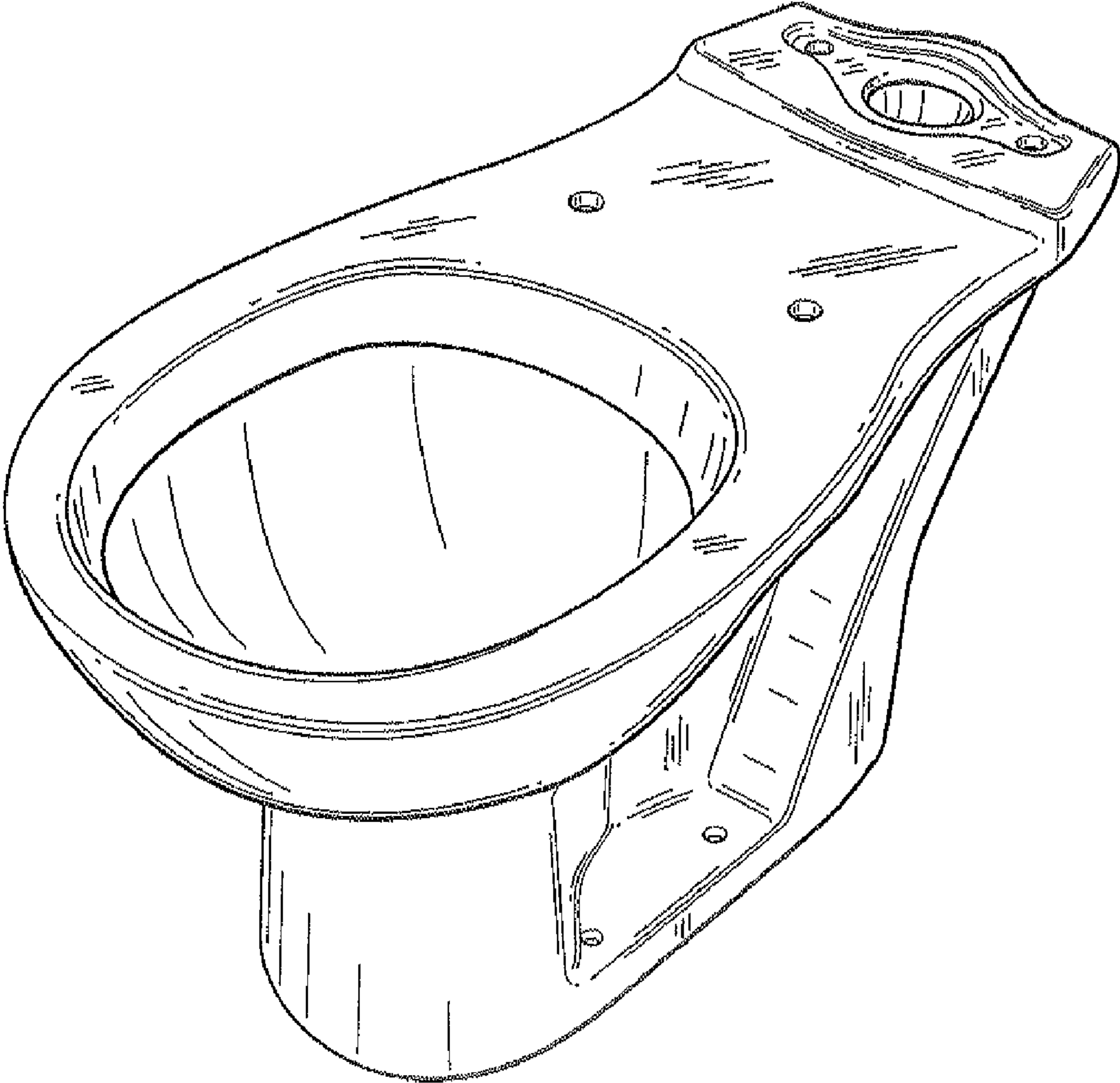

FIG. 1

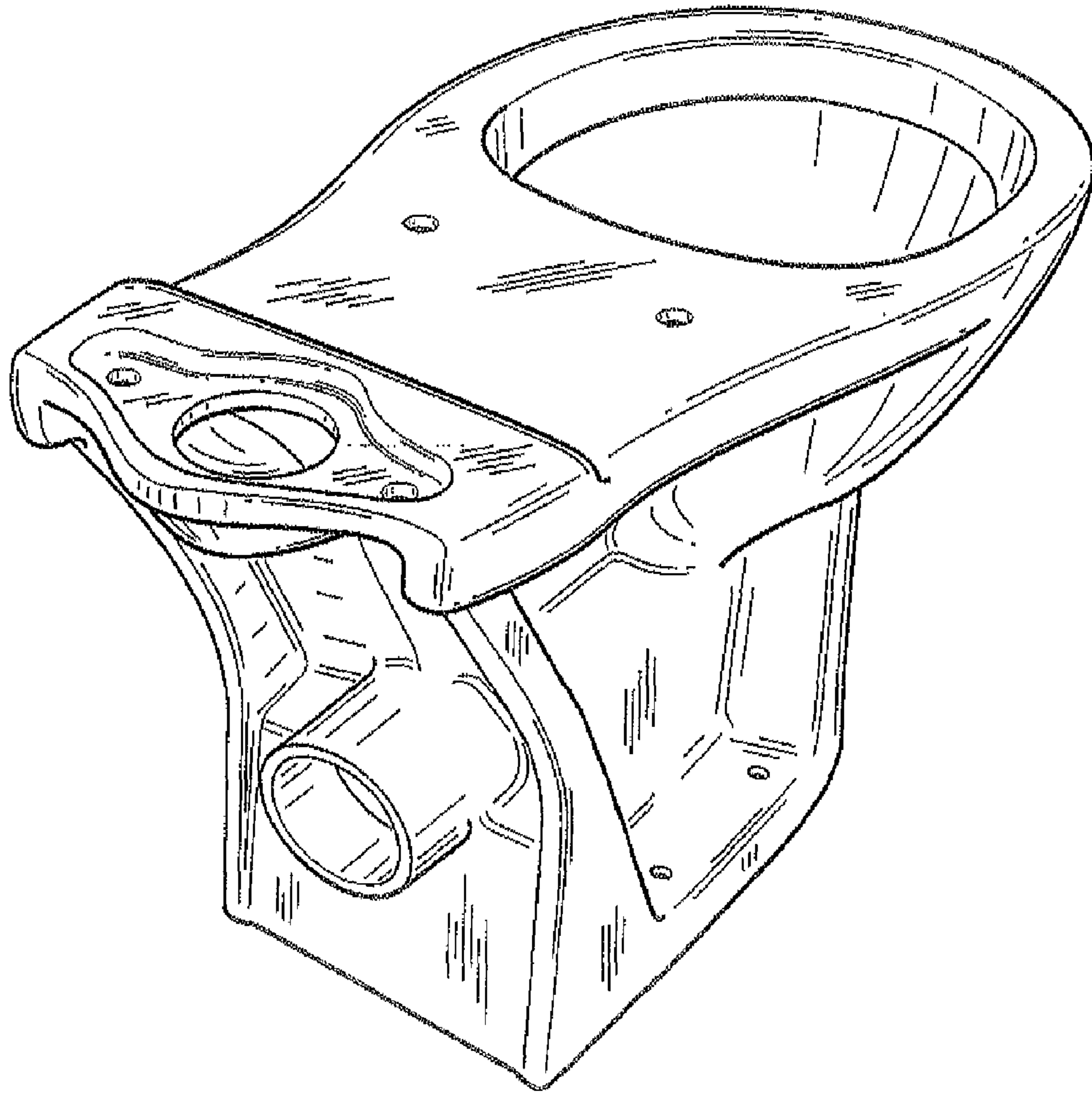

FIG. 2

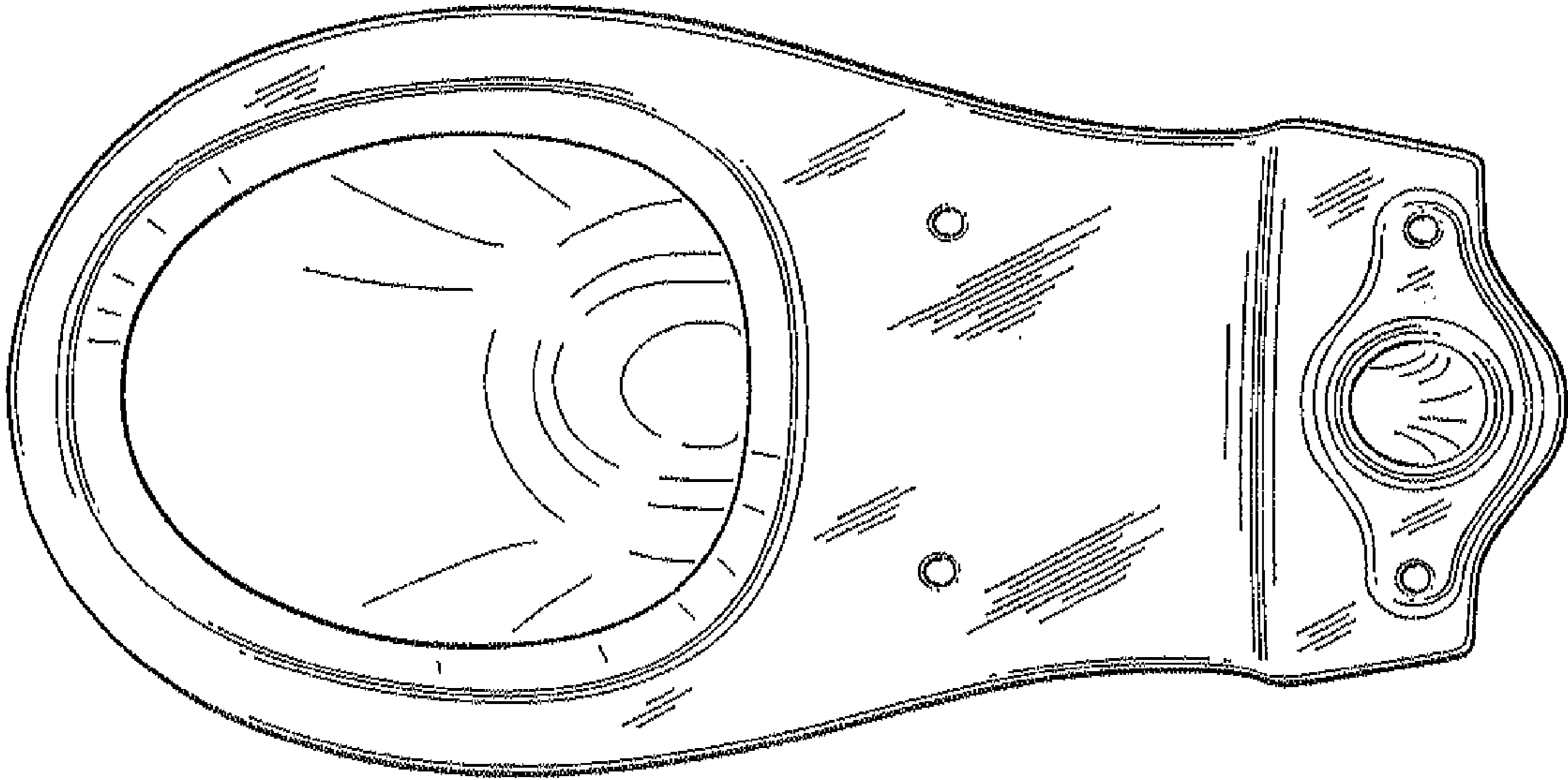

FIG. 3

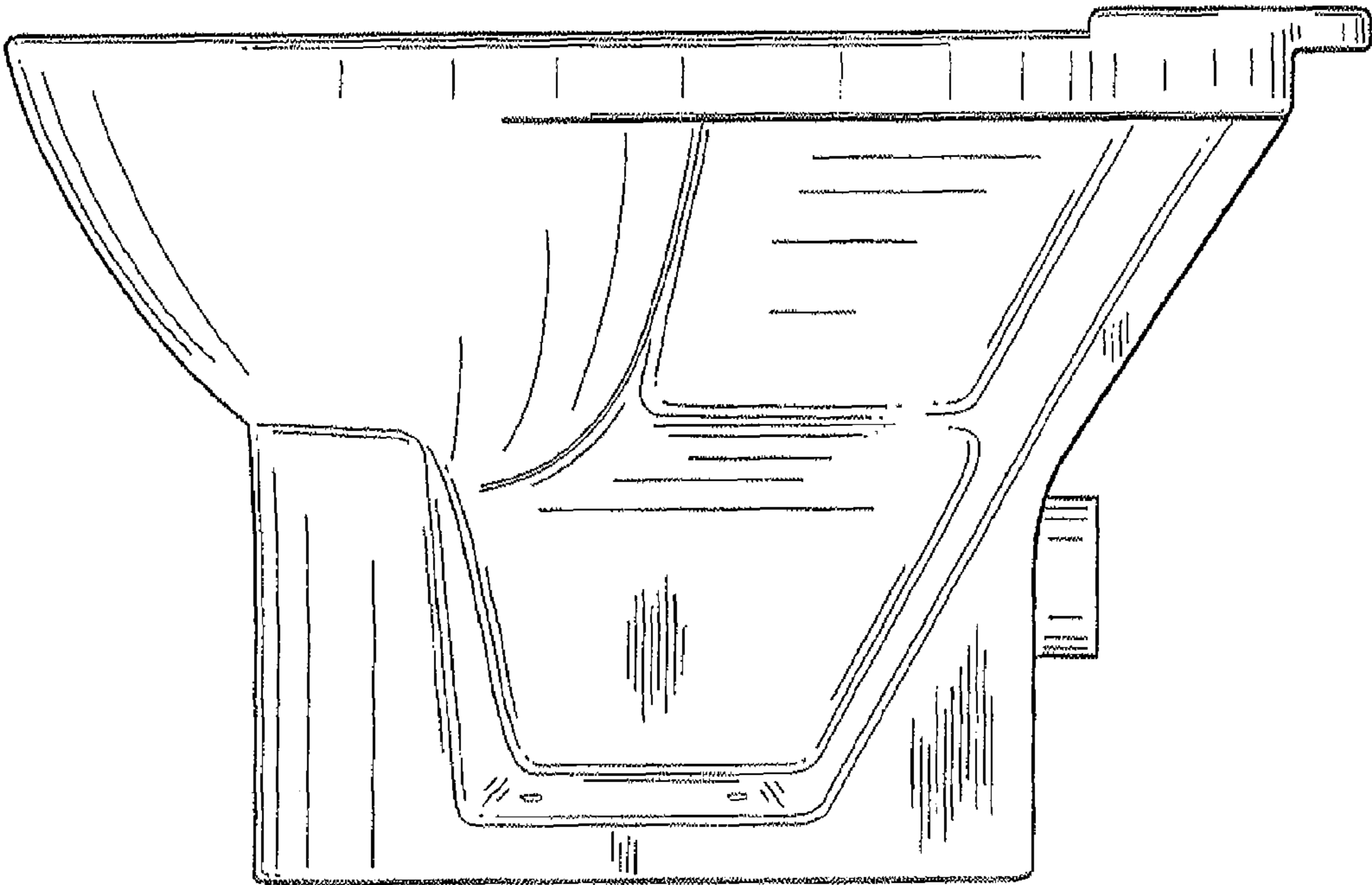

FIG. 4

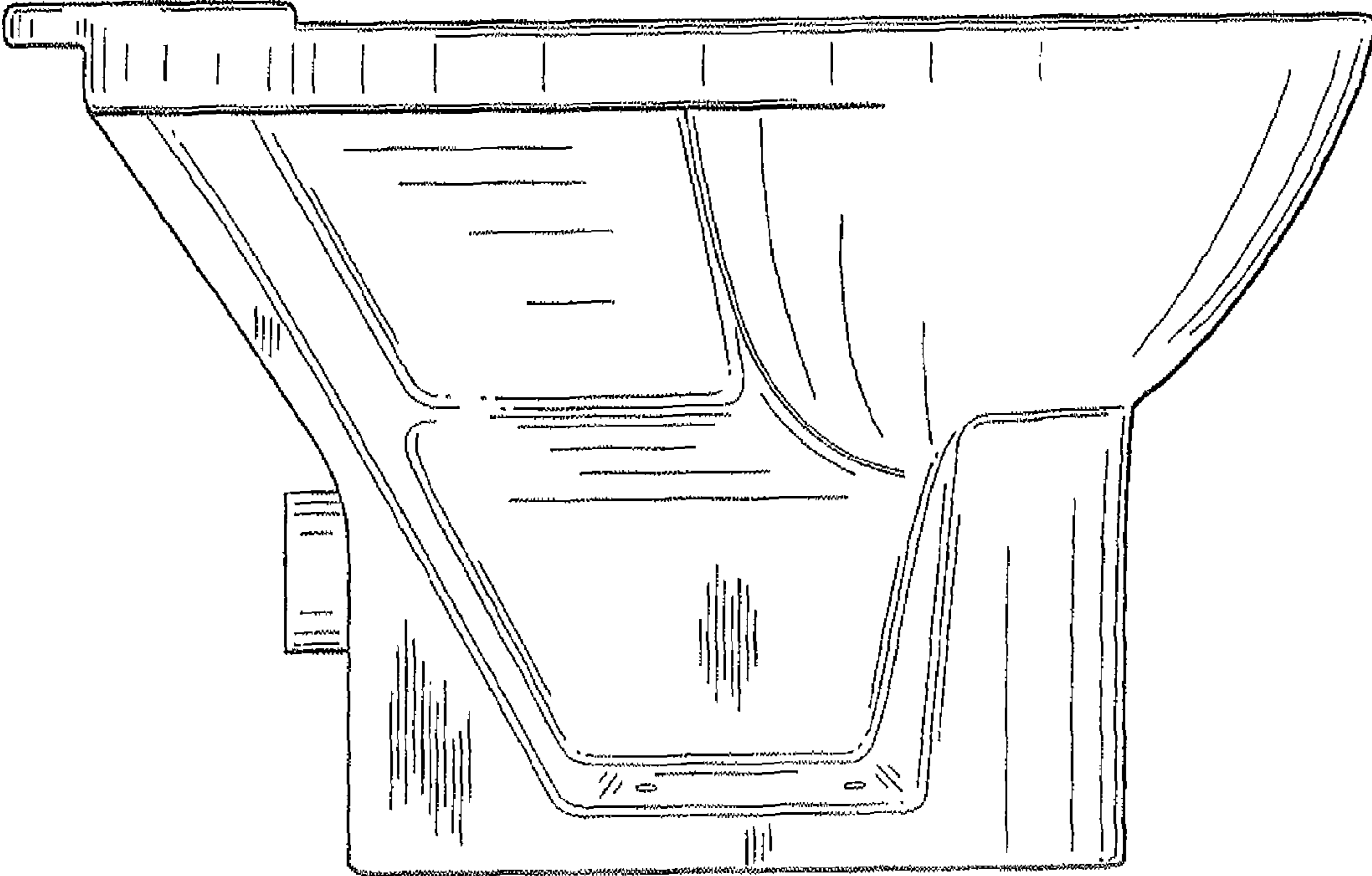

FIG. 5

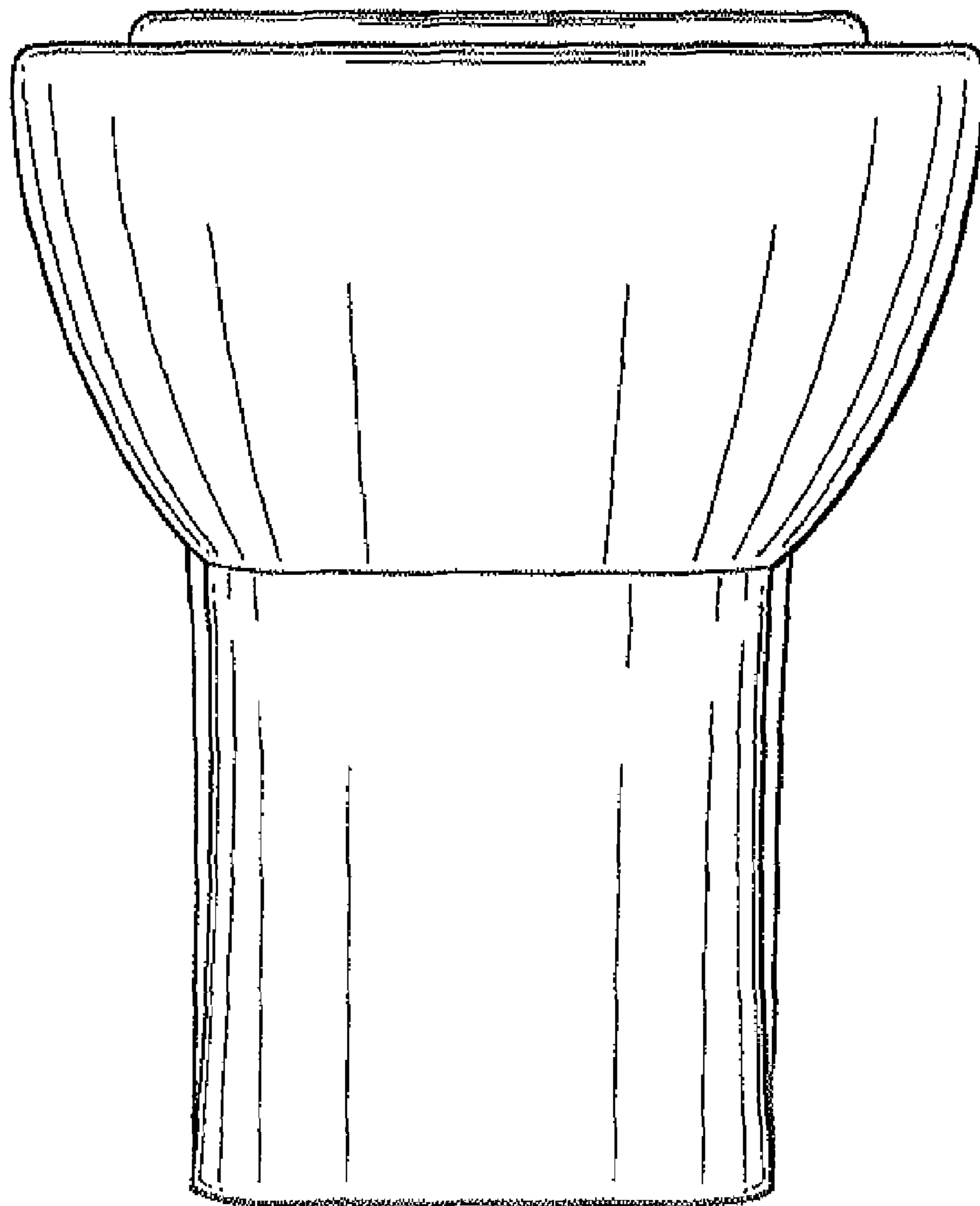

FIG. 6

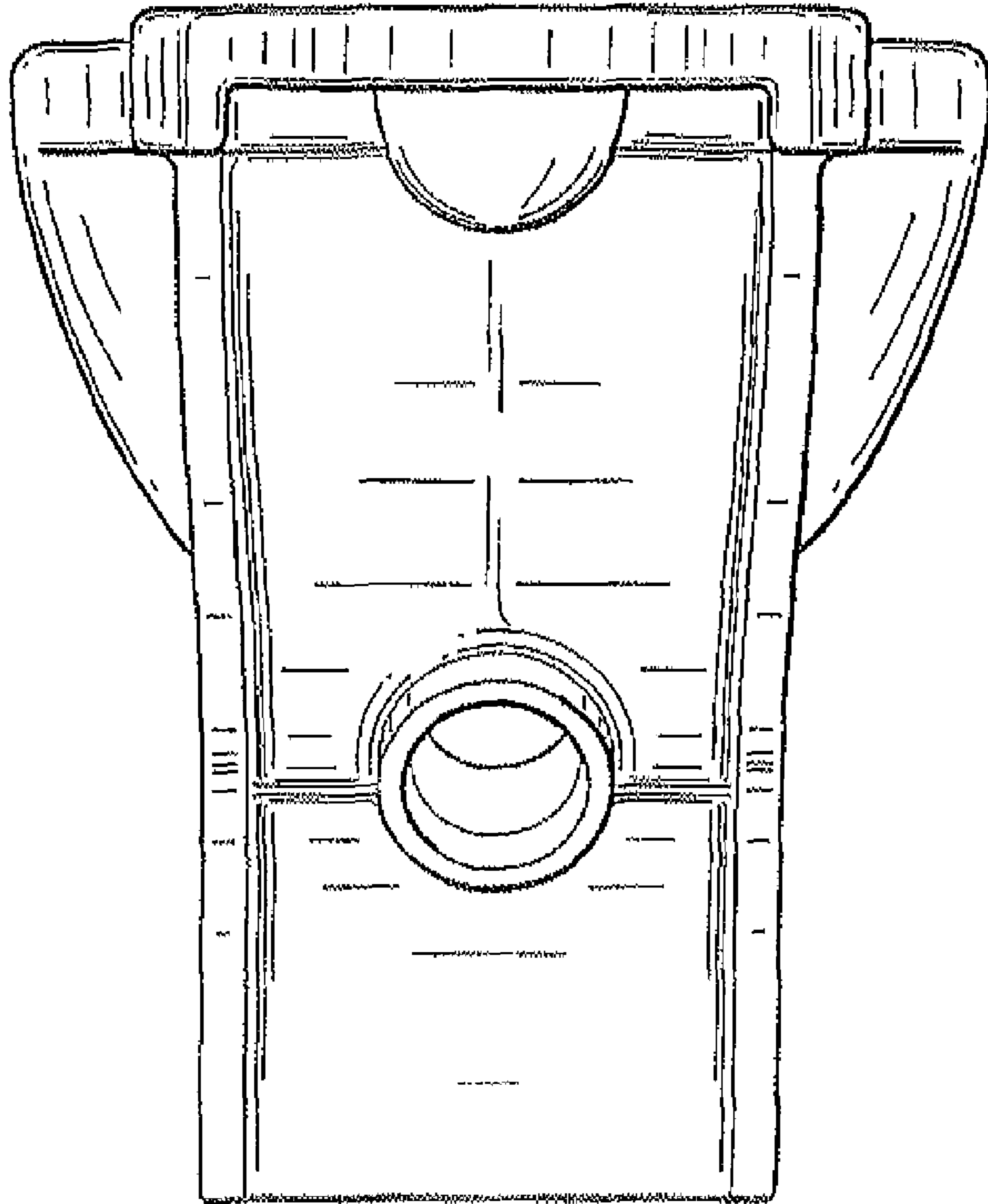

FIG. 7

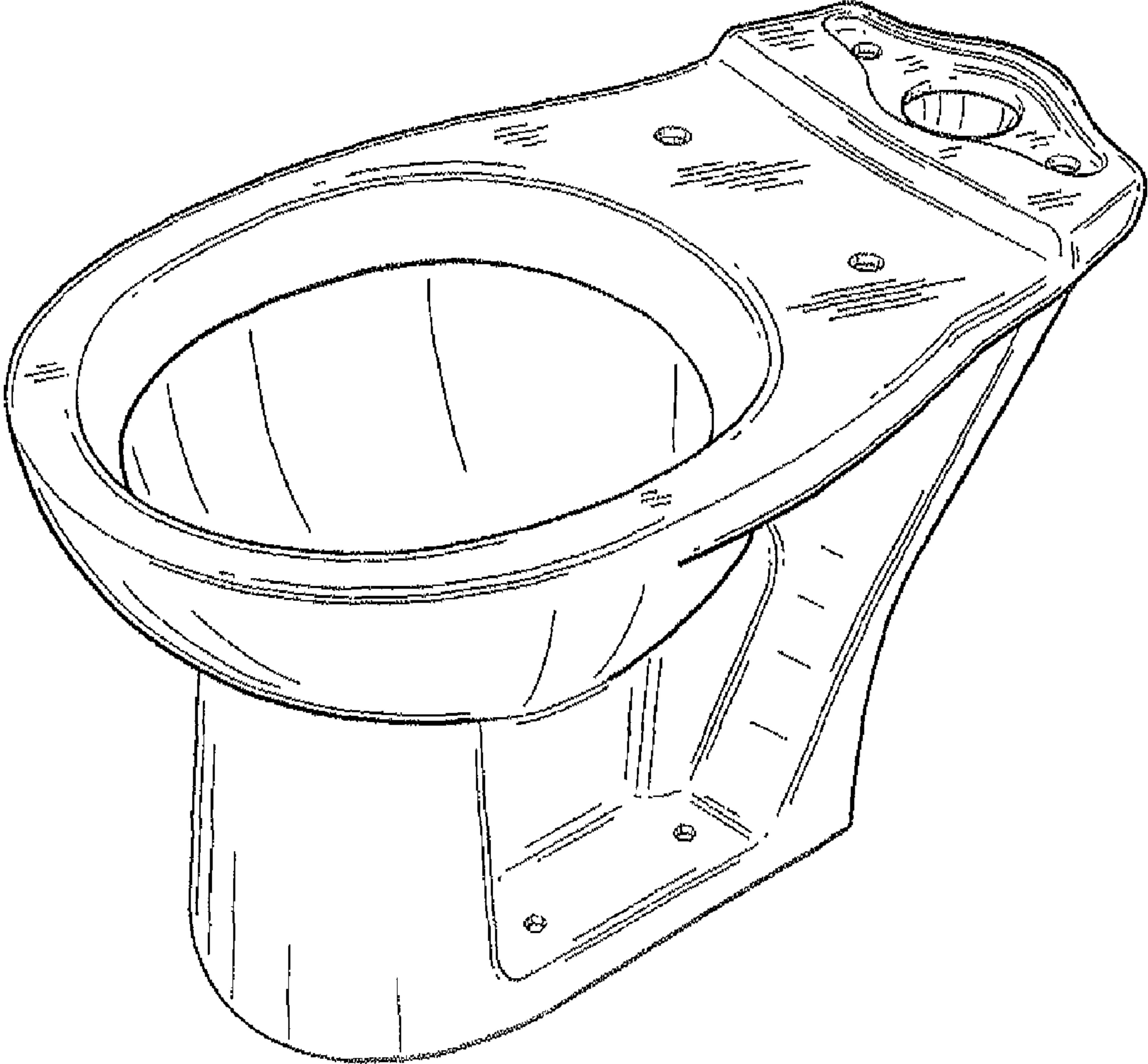

FIG. 8

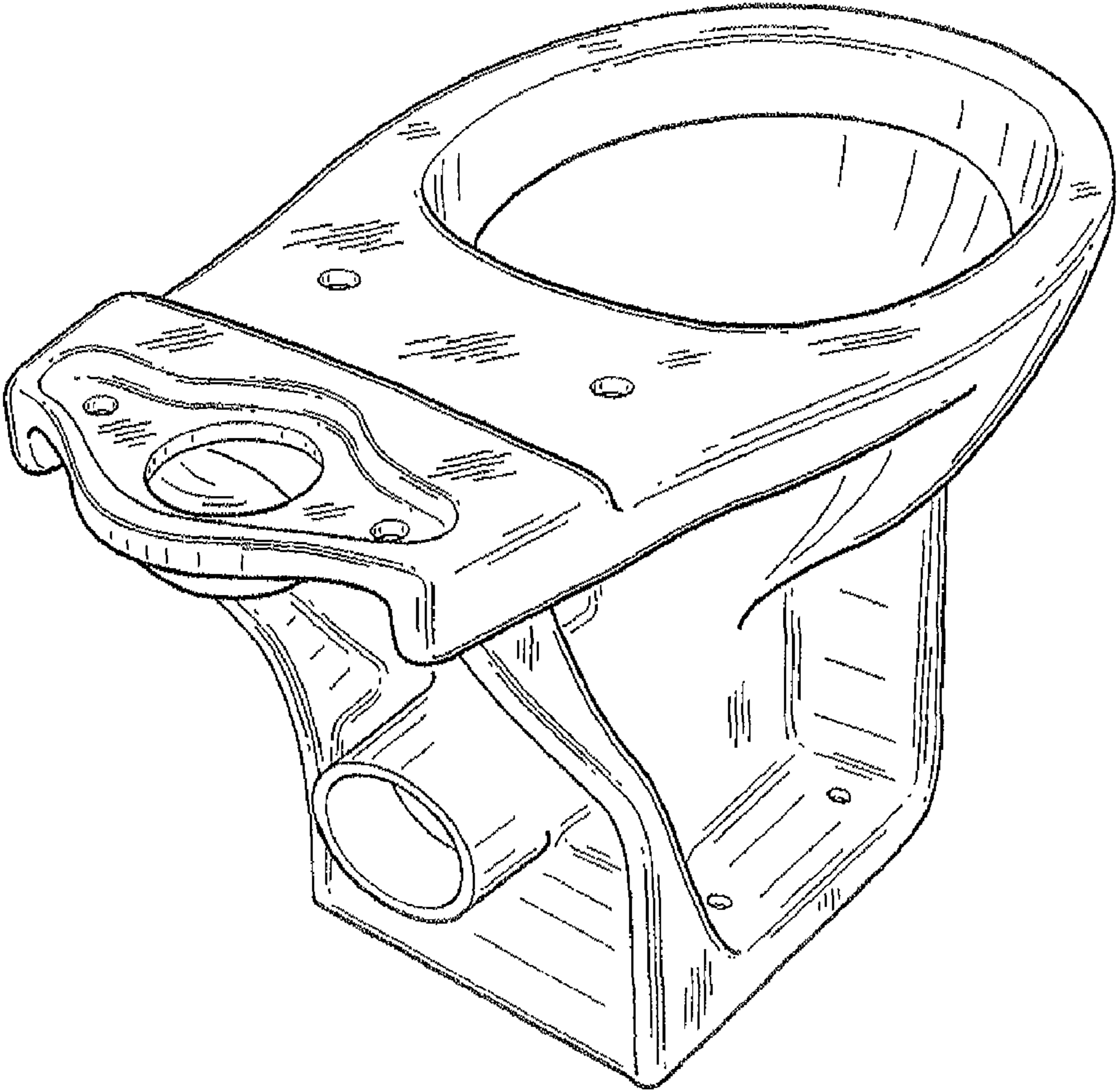

FIG. 9

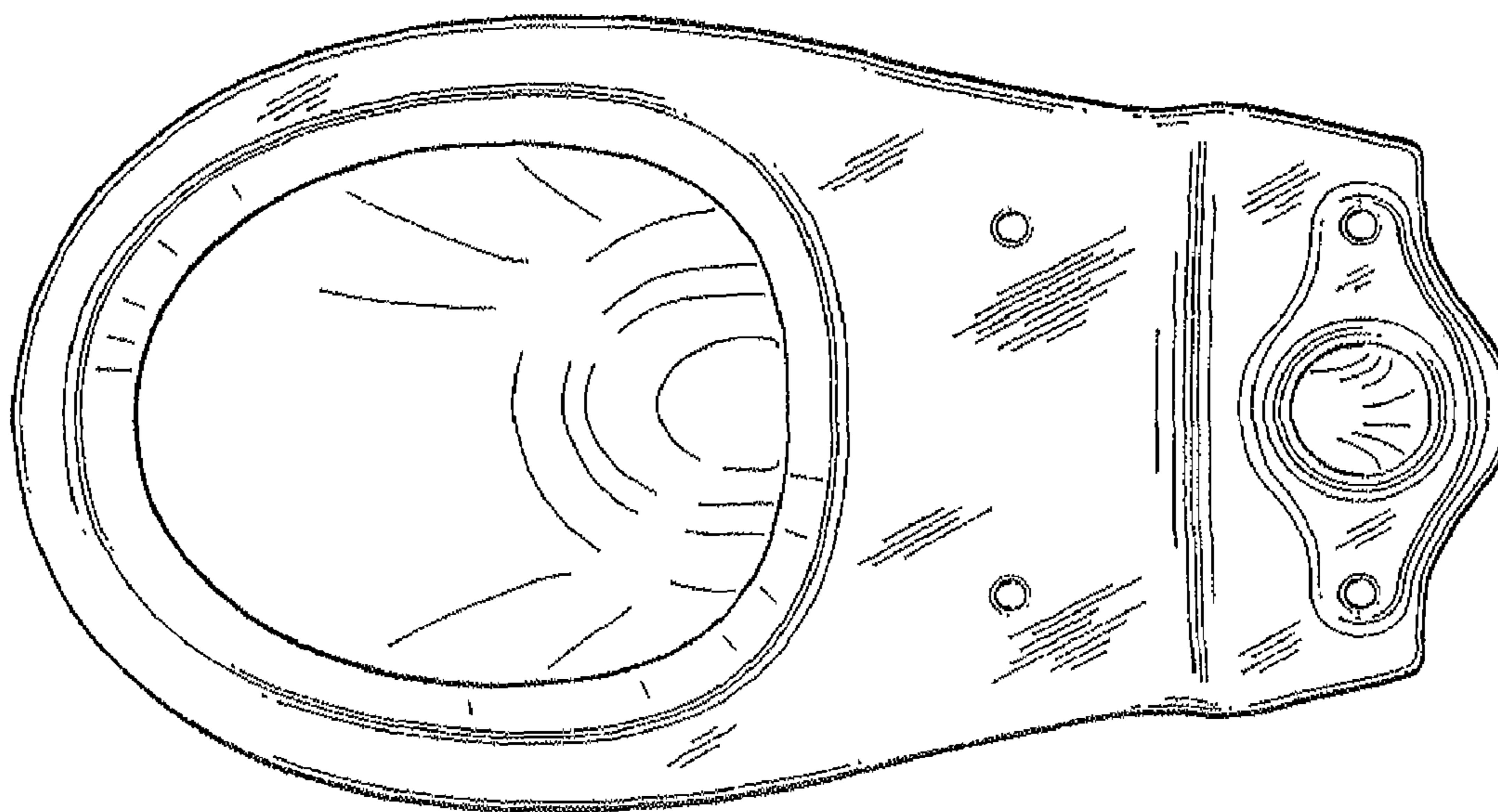

FIG. 10

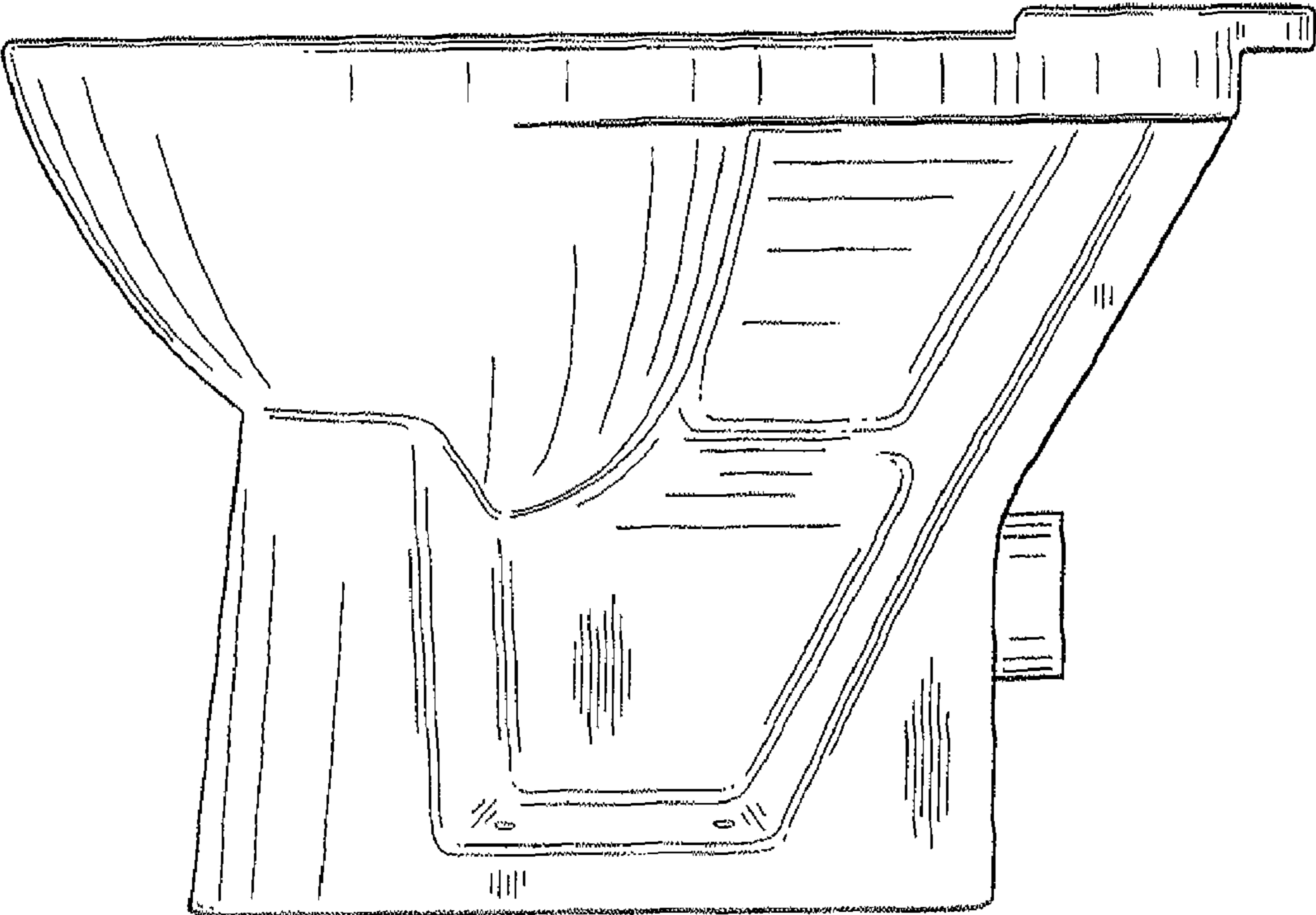

FIG. 11

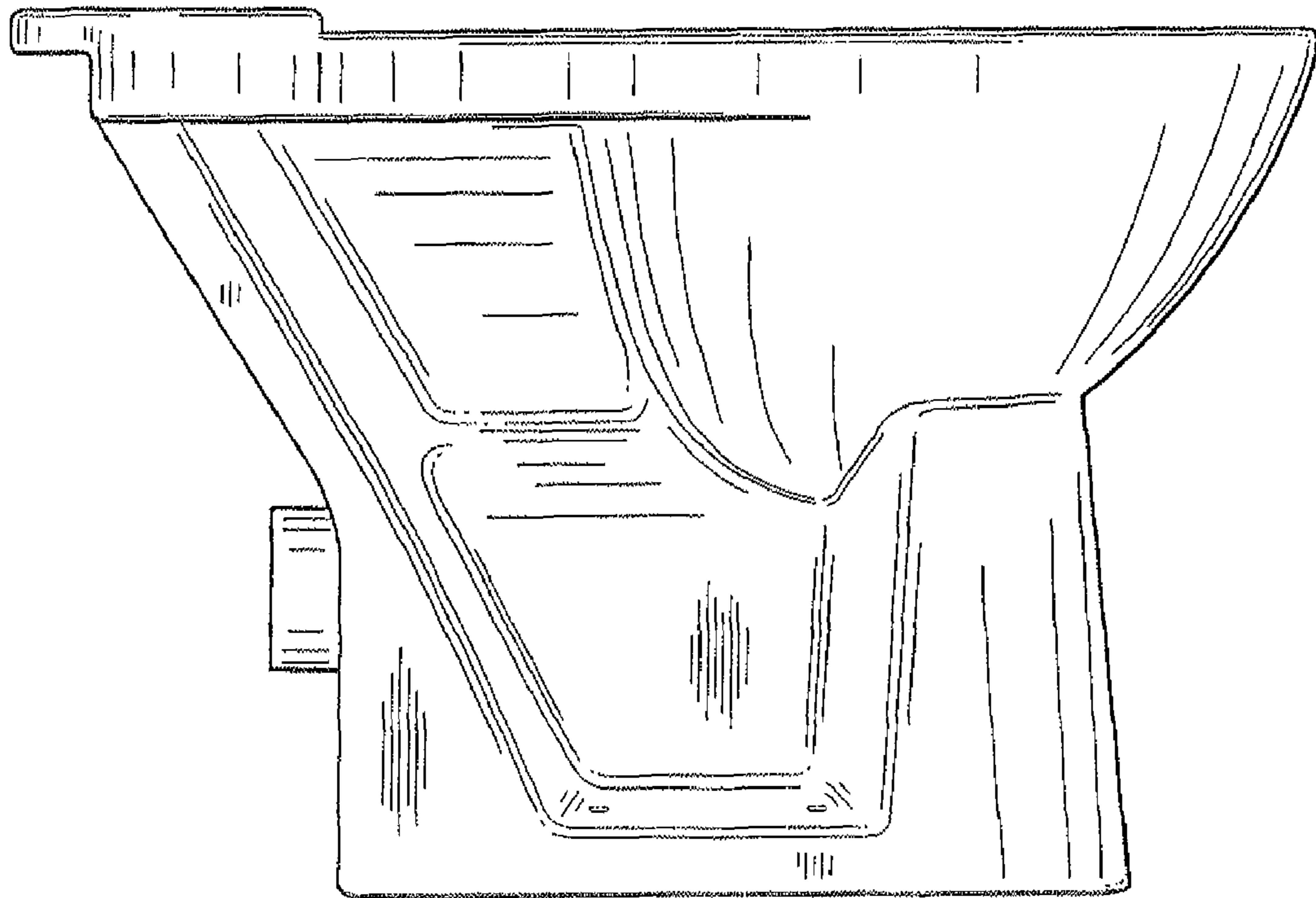

FIG. 12

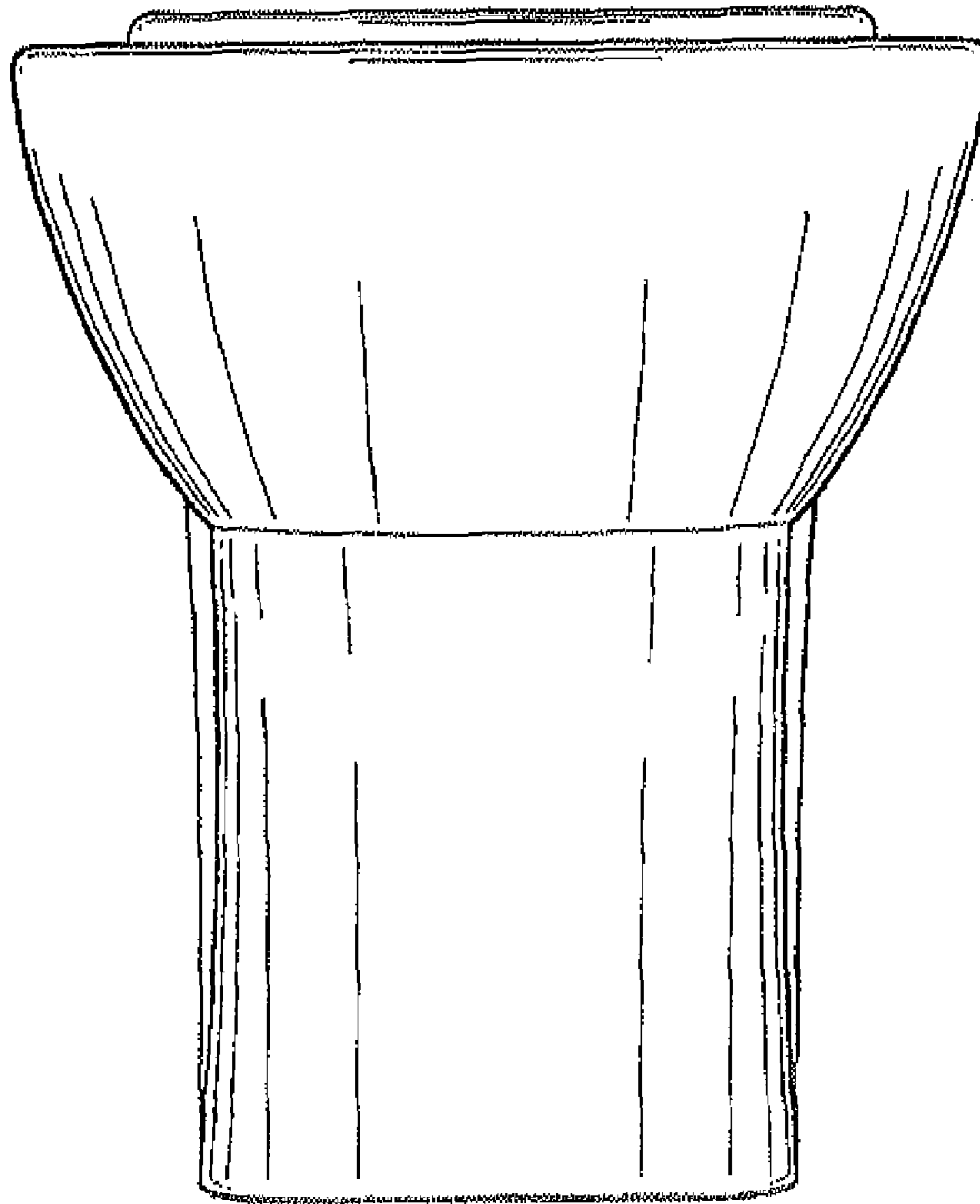

FIG. 13

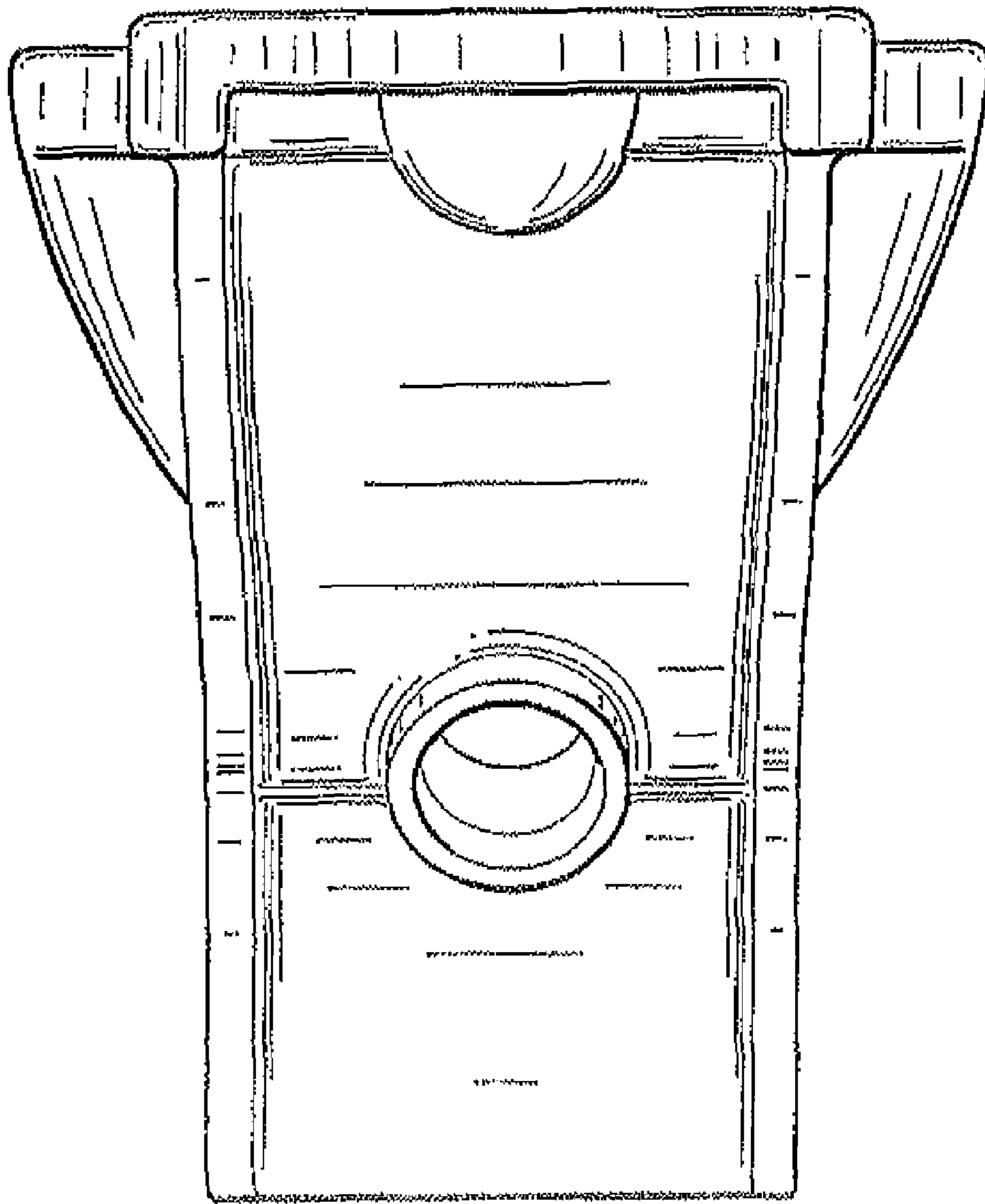

FIG. 14