



US00D656226S

(12) **United States Design Patent**
Erli

(10) **Patent No.:** **US D656,226 S**
(45) **Date of Patent:** **** Mar. 20, 2012**

(54) **INFANT TUB**

(75) Inventor: **Pierangelo Erli**, Telgate (IT)

(73) Assignee: **Okbaby S.R.L.** (IT)

(**) Term: **14 Years**

(21) Appl. No.: **29/381,824**

(22) Filed: **Dec. 23, 2010**

(51) **LOC (9) Cl.** **23-02**

(52) **U.S. Cl.** **D23/278**

(58) **Field of Classification Search** D23/278,
D23/304; 4/572.1, 586; D6/390

See application file for complete search history.

(56) **References Cited**

U.S. PATENT DOCUMENTS

D469,860 S *	2/2003	Riemer et al.	D23/278
D498,827 S *	11/2004	Shibata et al.	D23/278
D611,259 S *	3/2010	Yeung	D6/333
D619,225 S *	7/2010	Tu	D23/278

FOREIGN PATENT DOCUMENTS

IT	000211370-0001	10/2004
IT	000329040-0001	6/2005

* cited by examiner

Primary Examiner — Robert Delehanty

(74) *Attorney, Agent, or Firm* — Fish & Richardson P.C.

(57) **CLAIM**

The ornamental design for an infant tub, substantially as shown and described.

DESCRIPTION

FIG. 1 is a perspective view of my infant tub.
FIG. 2 is a front side view of my infant tub.
FIG. 3 is a rear side view of my infant tub.
FIG. 4 is a right side view of my infant tub.
FIG. 5 is a left side view of my infant tub.
FIG. 6 is a top view of my infant tub; and,
FIG. 7 is a bottom view of my infant tub.
The broken lines which define the bounds of the claimed design form no part thereof.

1 Claim, 5 Drawing Sheets

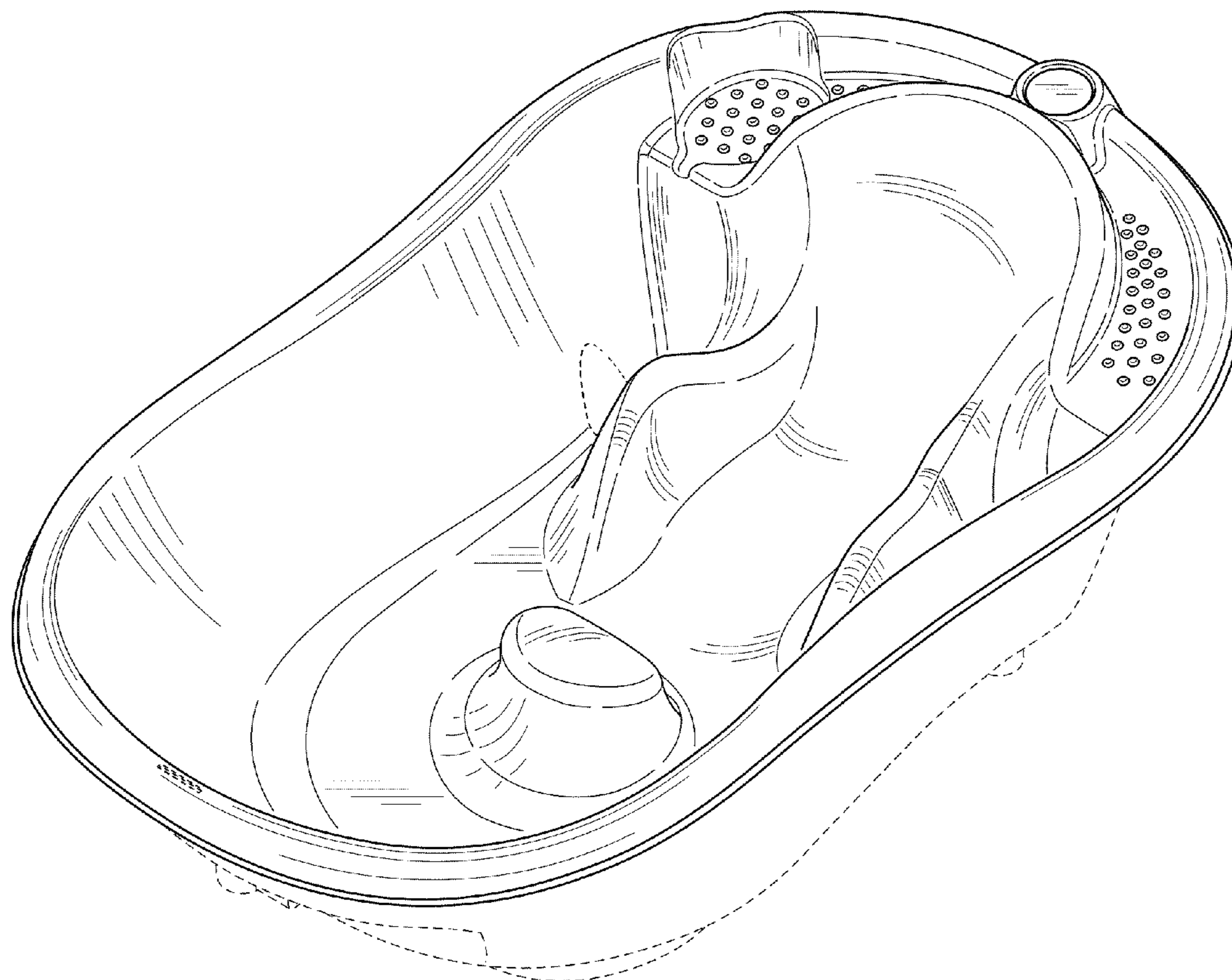

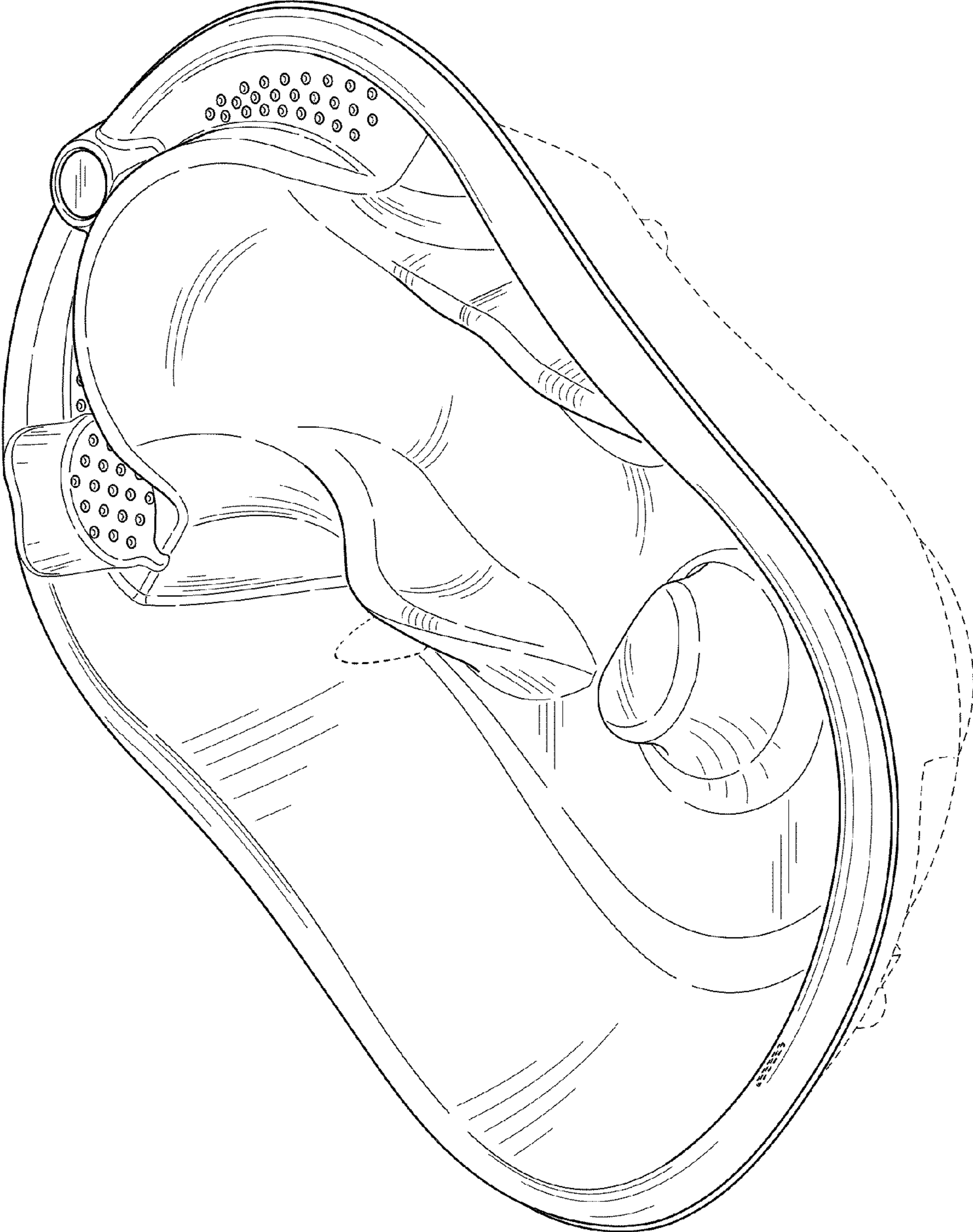

FIG. 1

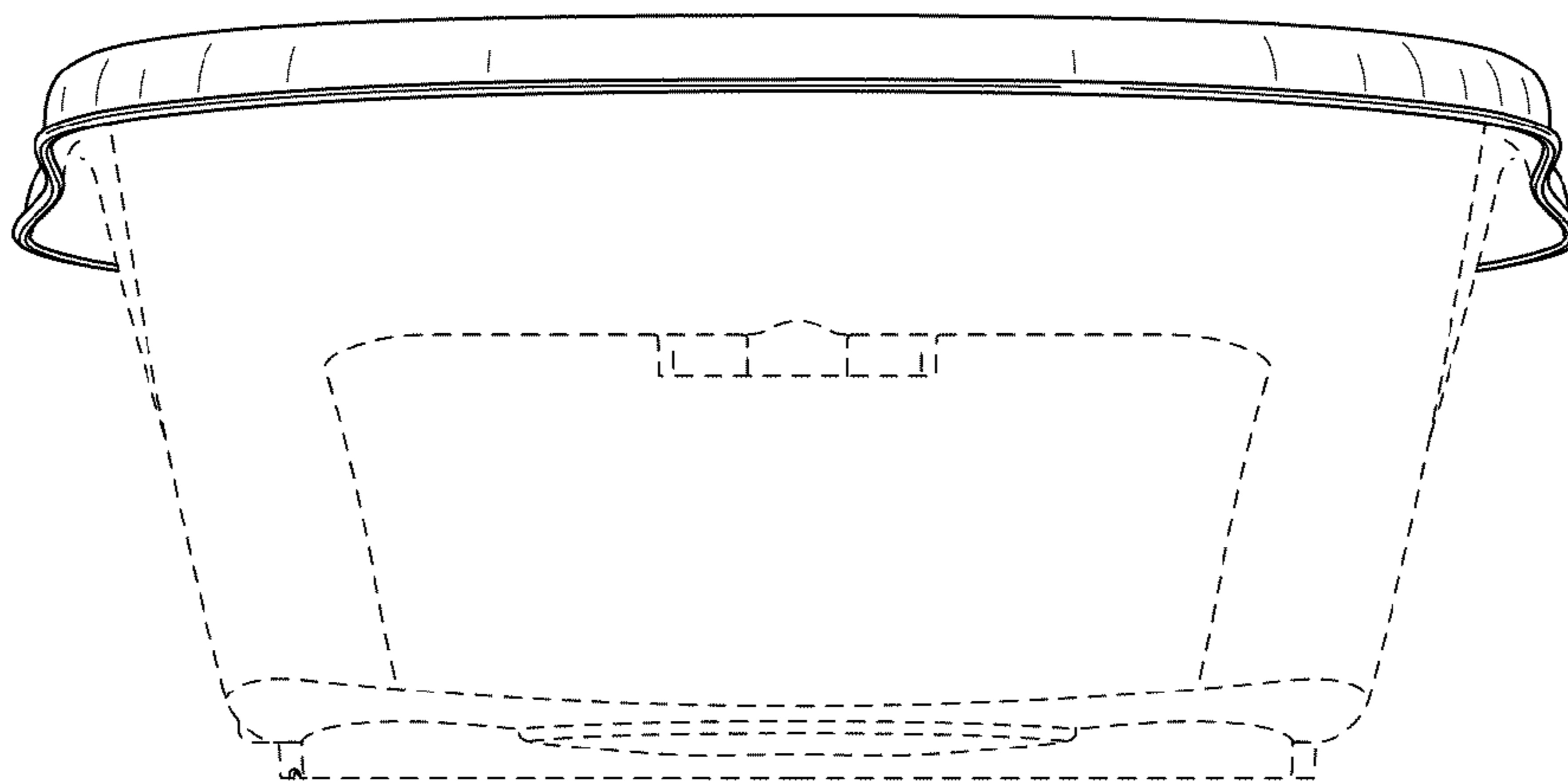

FIG. 2

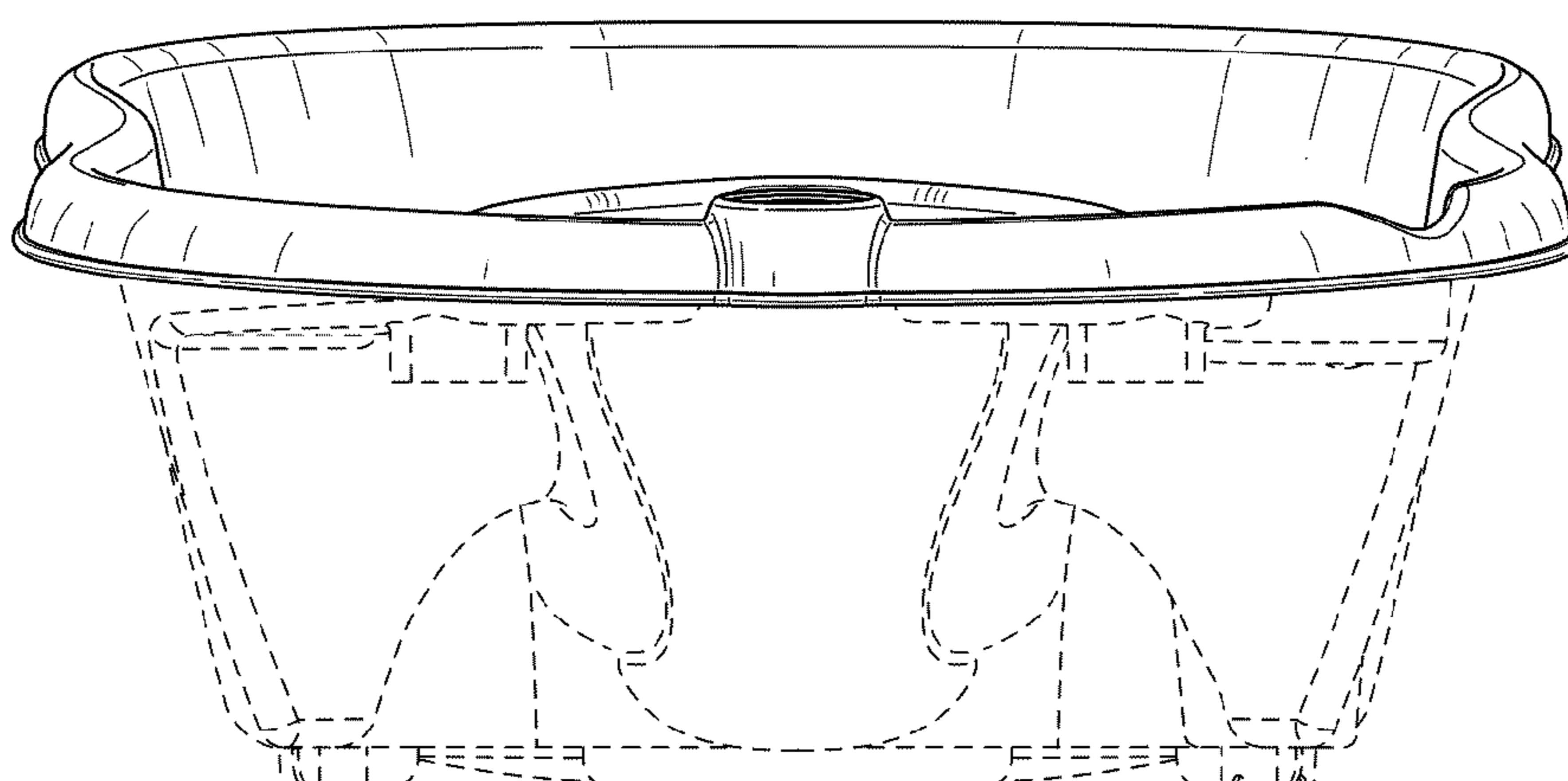

FIG. 3

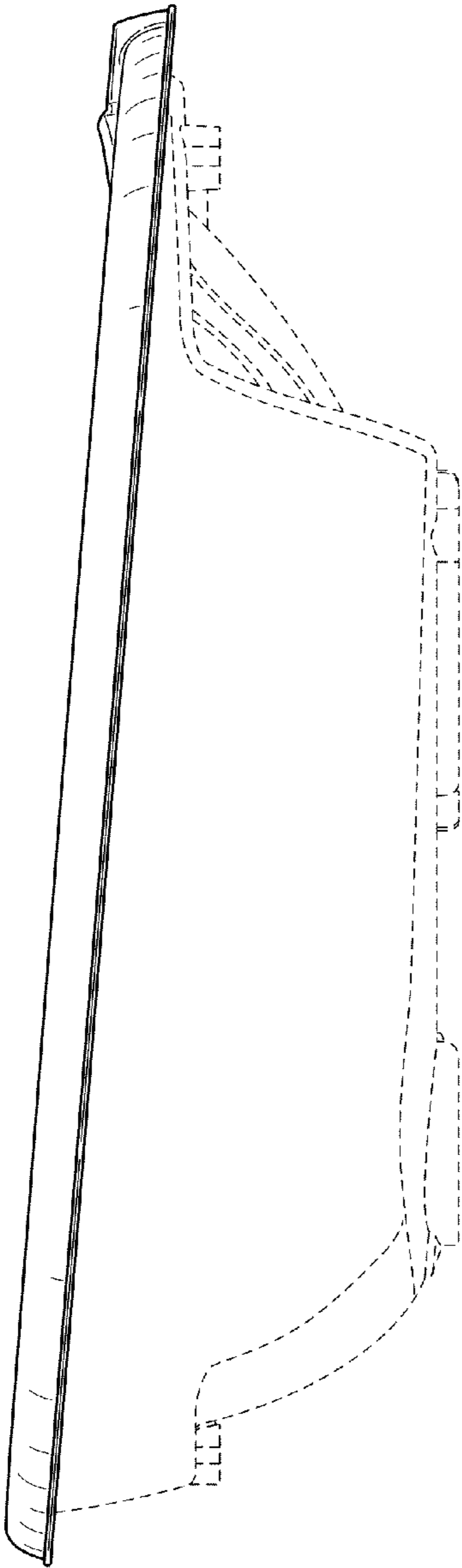

FIG. 4

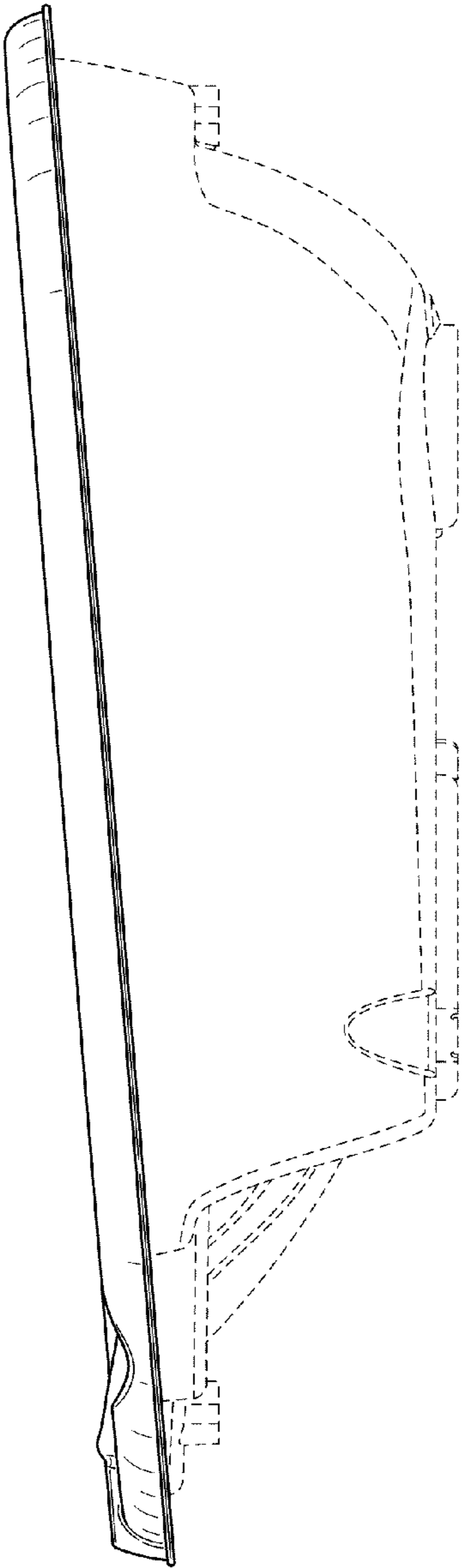

FIG. 5

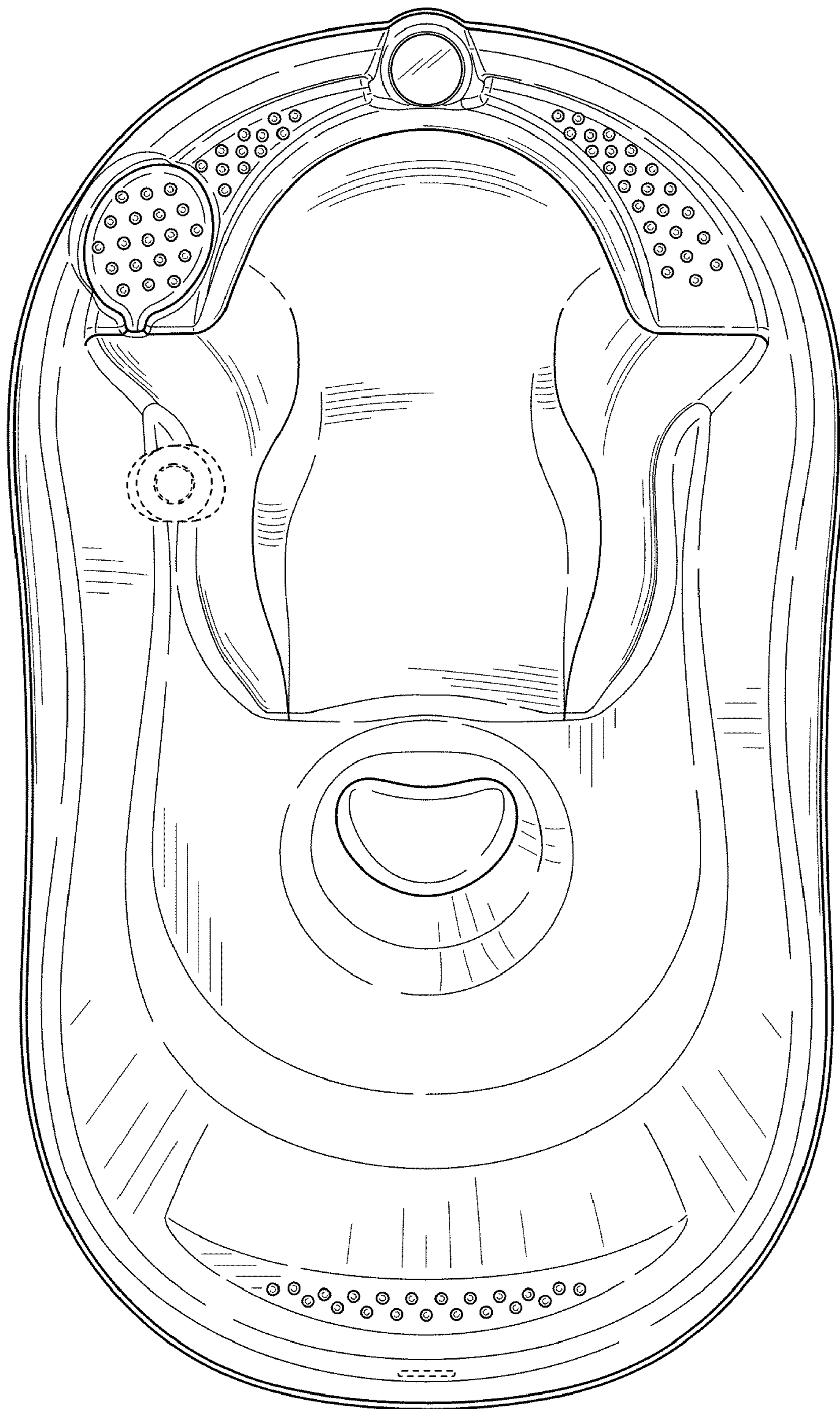

FIG. 6

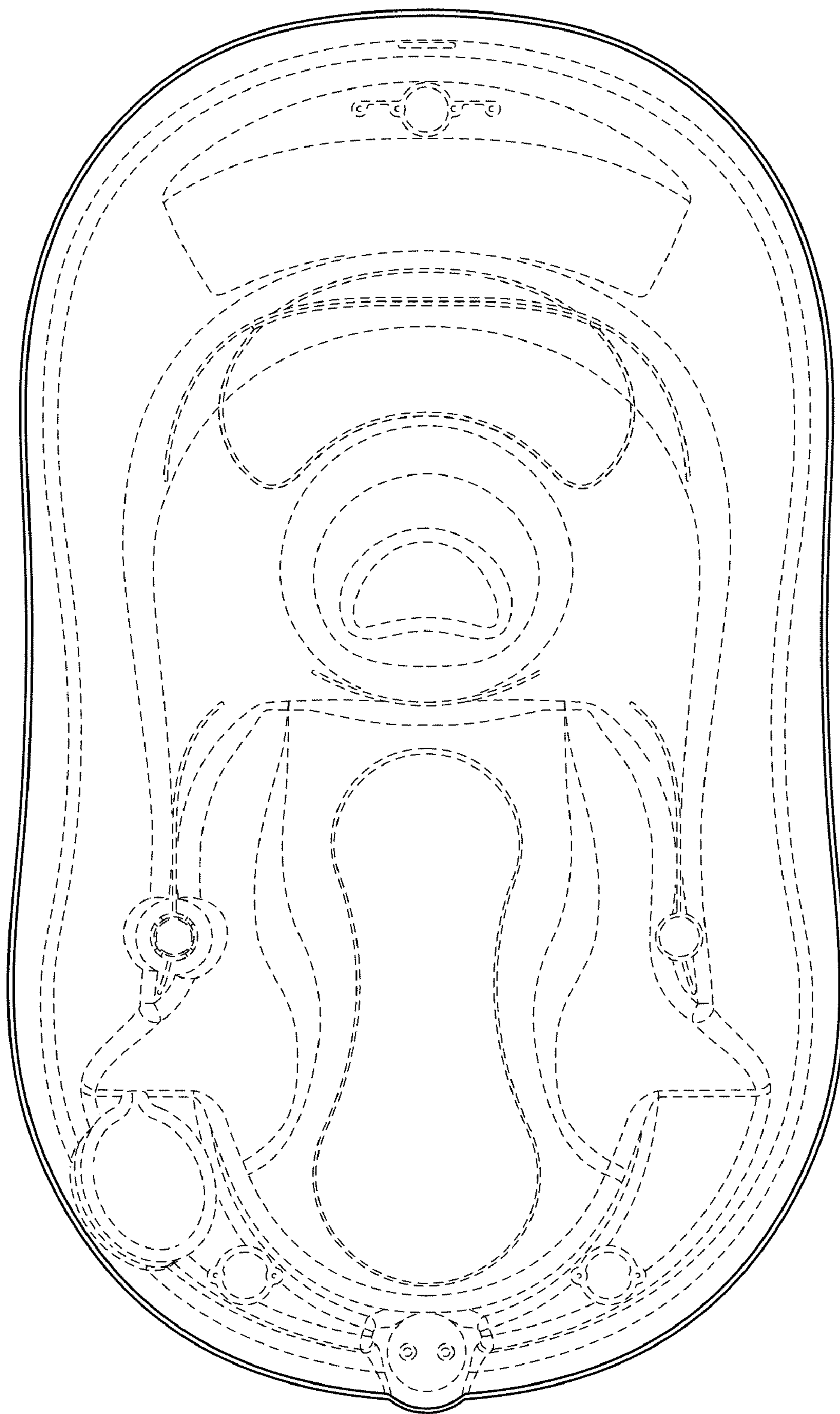

FIG. 7