



US00D656128S

(12) **United States Design Patent**
Park

(10) **Patent No.:** **US D656,128 S**
(45) **Date of Patent:** **** Mar. 20, 2012**

(54) **BLUETOOTH EARSET**

(75) Inventor: **Min-Young Park**, Ansan-si (KR)

(73) Assignee: **Samsung Electronics Co., Ltd.** (KR)

(**) Term: **14 Years**

(21) Appl. No.: **29/387,006**

(22) Filed: **Mar. 8, 2011**

(30) **Foreign Application Priority Data**

Nov. 2, 2010 (KR) 30-2010-0047504

(51) **LOC (9) Cl.** **14-01**

(52) **U.S. Cl.** **D14/223**

(58) **Field of Classification Search** D14/205,
D14/206, 223; 379/430, 433.01, 433.02;
381/380, 381, 370; D24/174; 128/866, 867;
455/90.3, 575.2

See application file for complete search history.

(56) **References Cited**

U.S. PATENT DOCUMENTS

D538,271 S * 3/2007 Kim et al. D14/223
D566,693 S * 4/2008 Jensen et al. D14/223
D575,277 S * 8/2008 Gaarde et al. D14/223

D582,897 S * 12/2008 Christopher et al. D14/223
D595,698 S * 7/2009 Guccione et al. D14/223
D598,900 S * 8/2009 Wikel et al. D14/223
D602,006 S * 10/2009 Kim et al. D14/223
D602,007 S * 10/2009 Lee et al. D14/223
D602,476 S * 10/2009 Lee et al. D14/223
D618,221 S * 6/2010 Fahrendorff et al. D14/223
D628,194 S * 11/2010 Koch D14/223
D630,620 S * 1/2011 Lee et al. D14/223
D640,242 S * 6/2011 Fahrendorff et al. D14/223
D647,512 S * 10/2011 McConnell et al. D14/223

* cited by examiner

Primary Examiner — Paula Greene

(74) *Attorney, Agent, or Firm* — Cantor Colburn LLP

(57) **CLAIM**

The ornamental design for a bluetooth earset, as shown and described.

DESCRIPTION

FIG. 1 is a perspective view of bluetooth earset, showing my new design;
FIG. 2 is a front elevational view thereof;
FIG. 3 is a rear elevational view thereof;
FIG. 4 is a left side elevational view thereof;
FIG. 5 is a right side elevational view thereof;
FIG. 6 is a top plan view thereof; and,
FIG. 7 is a bottom plan view thereof.

1 Claim, 7 Drawing Sheets

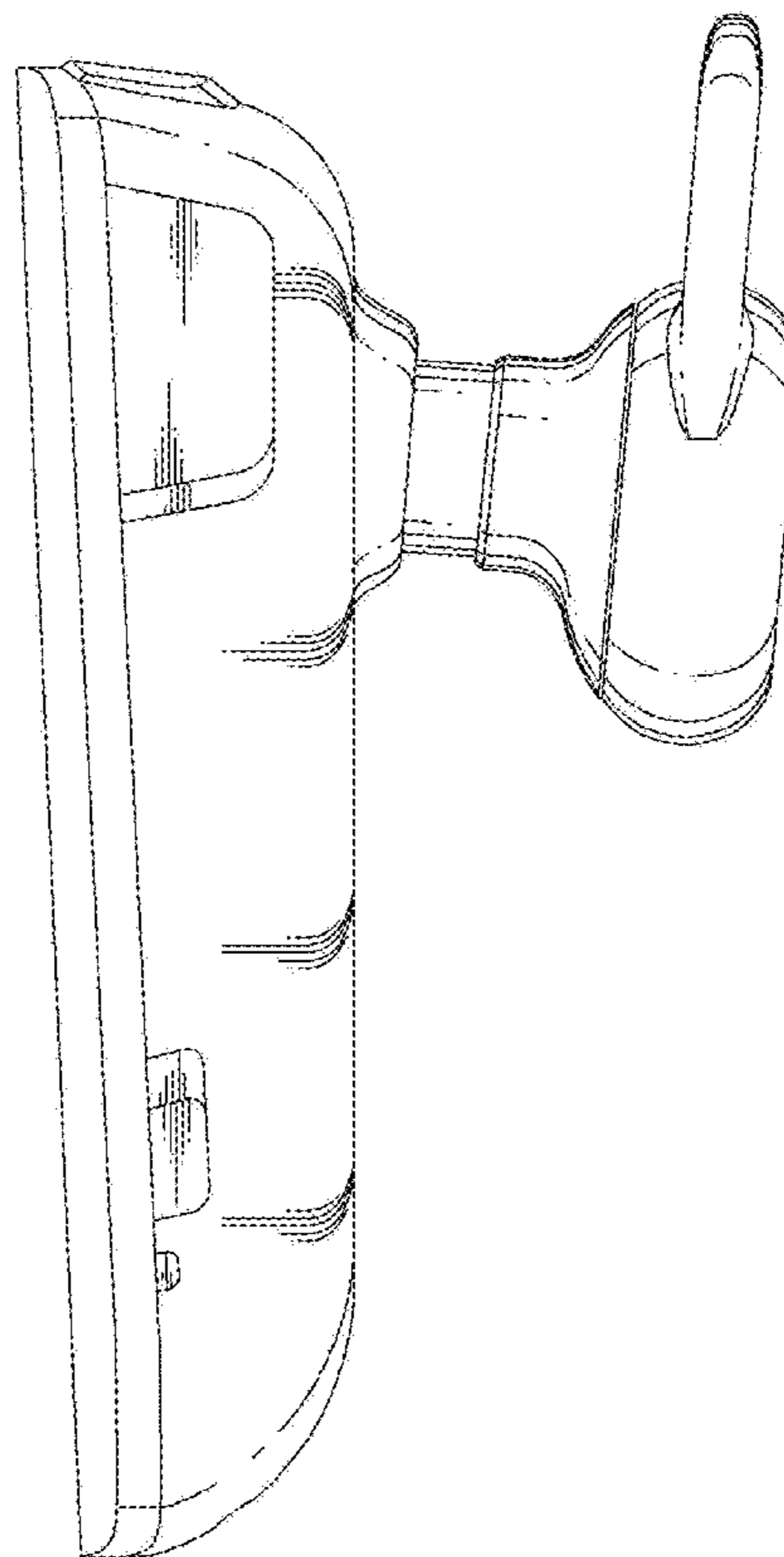
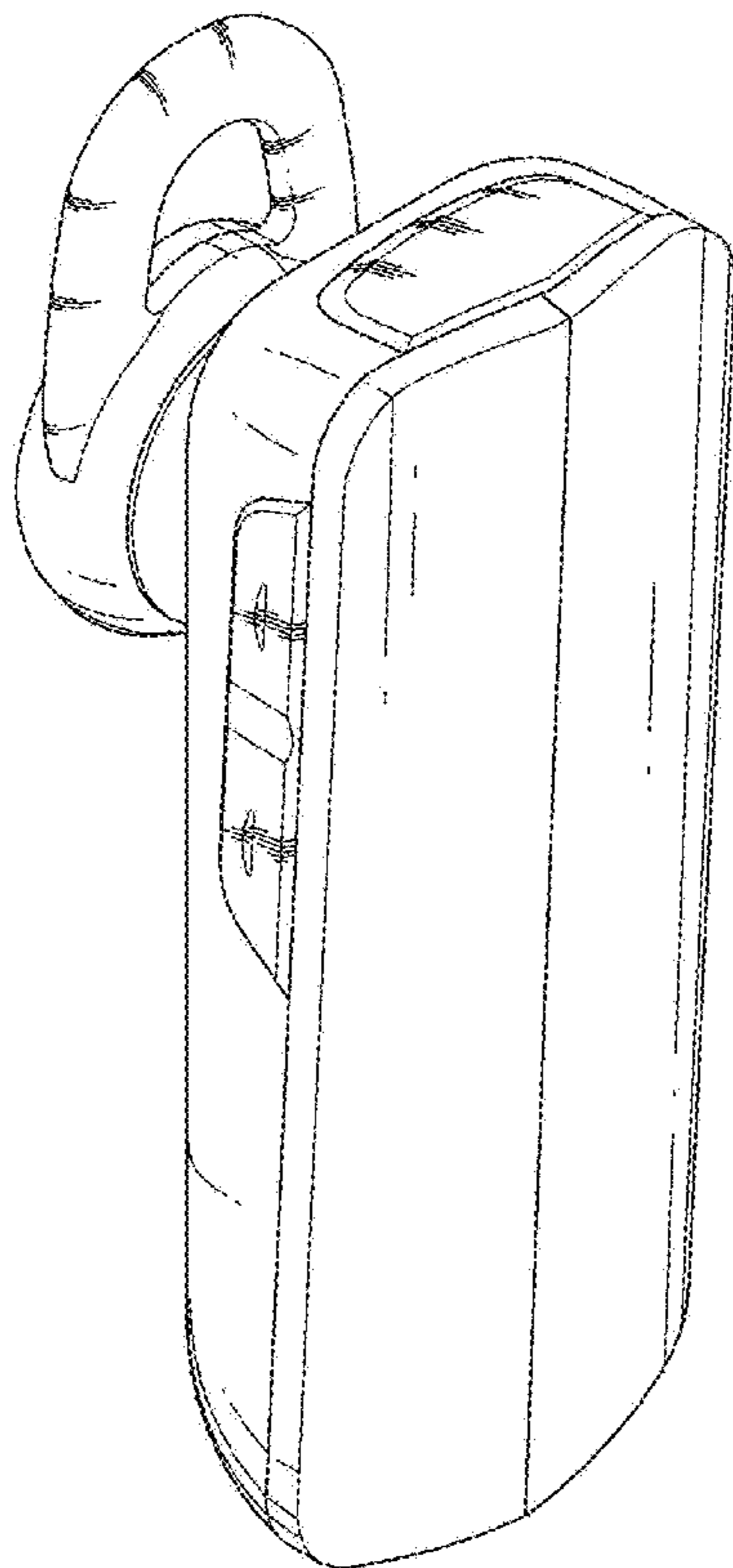

FIG. 1



FIG. 2

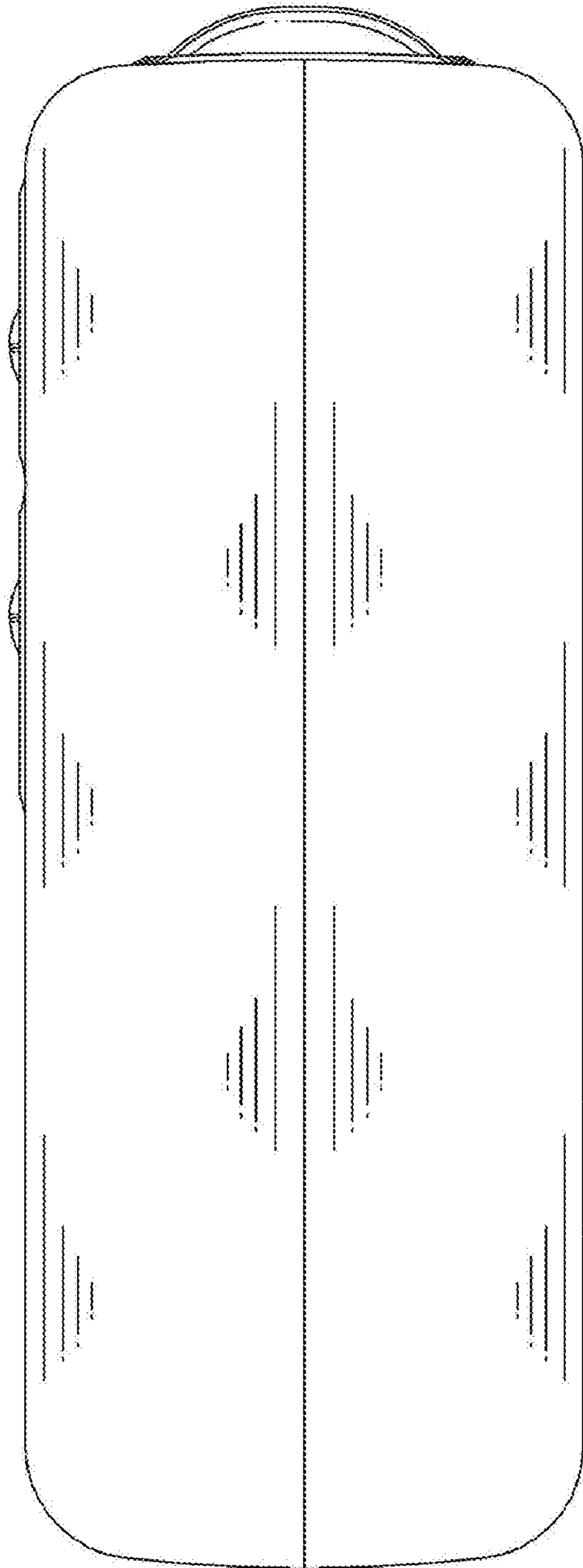

FIG. 3

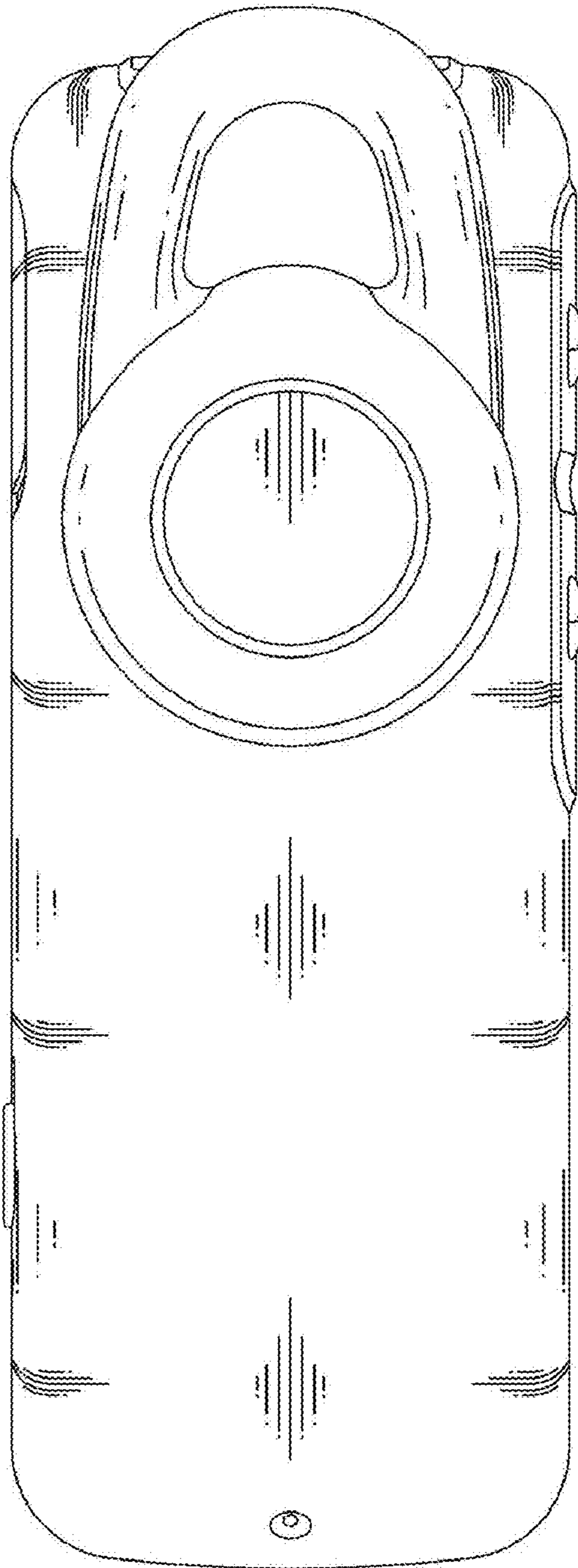

FIG. 4

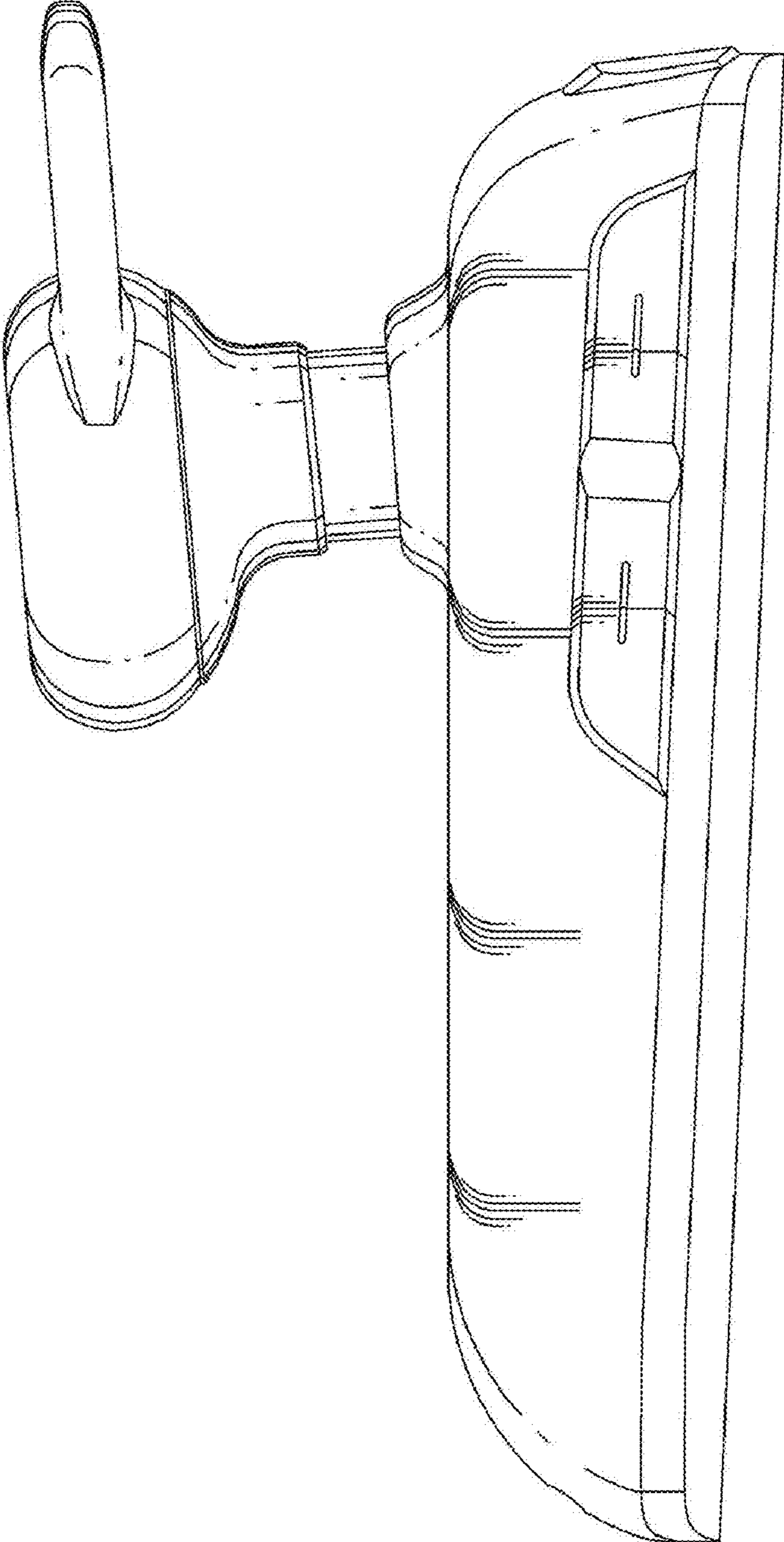

FIG. 5

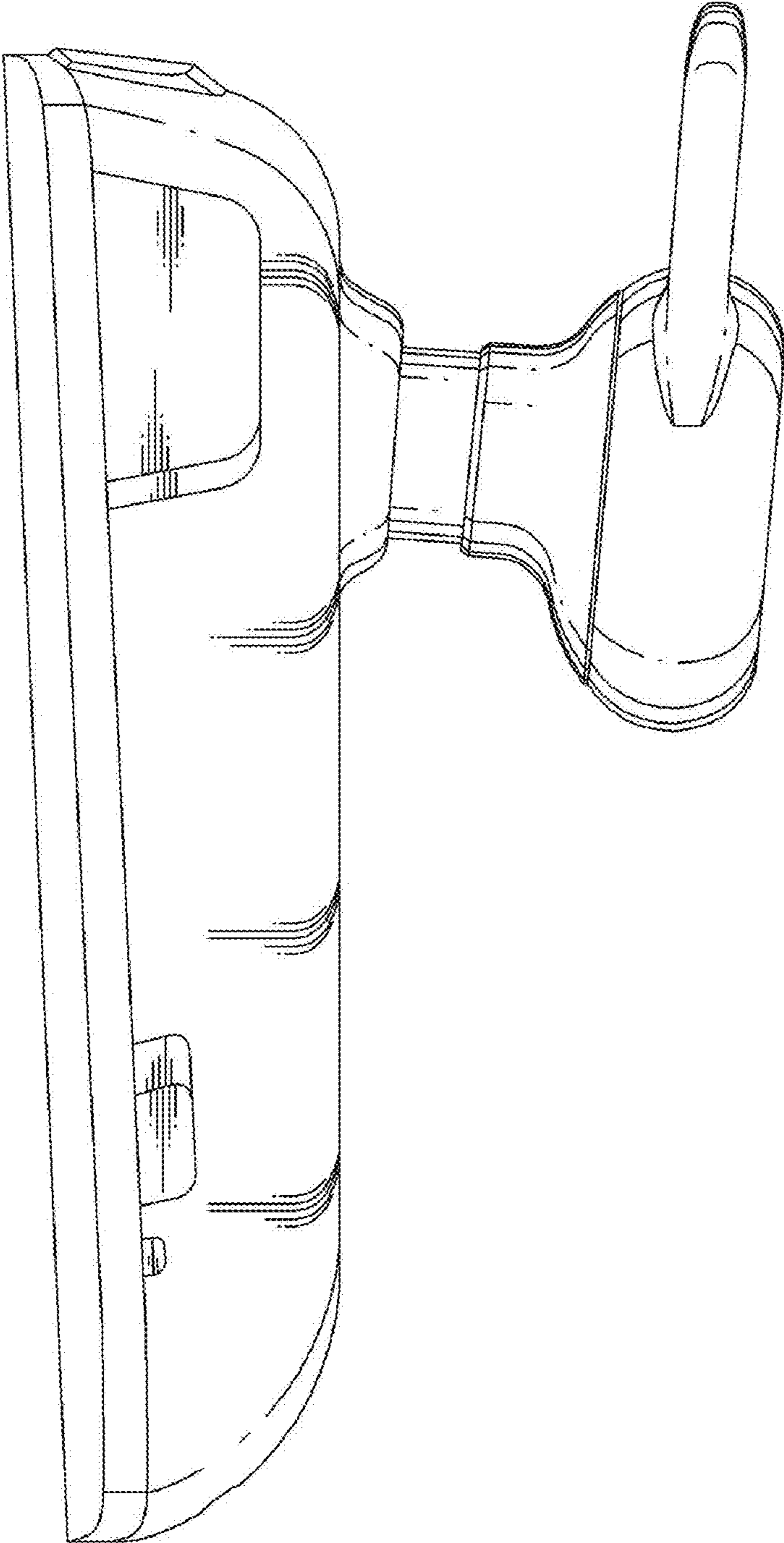

FIG. 6

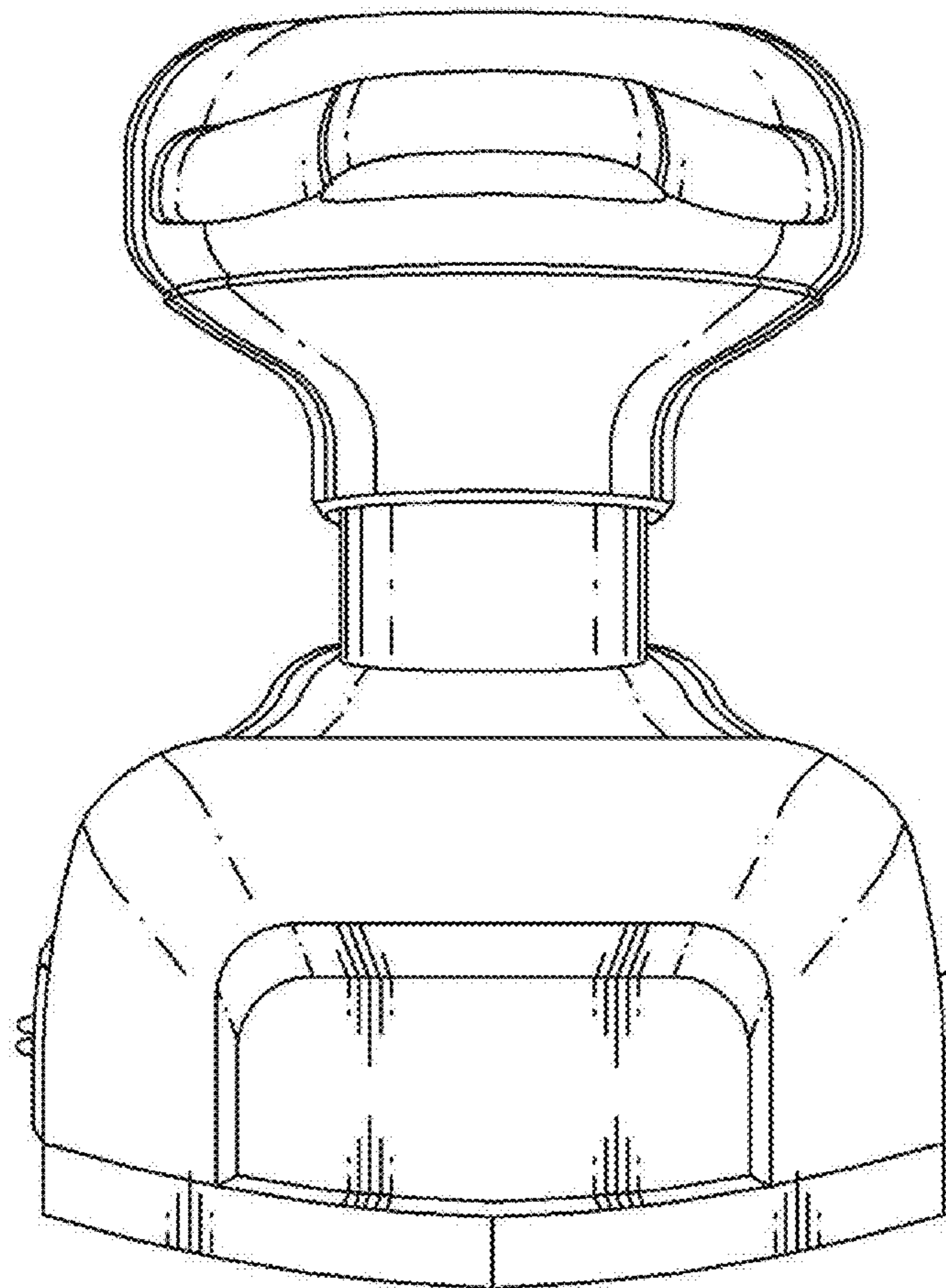

FIG. 7

