



US00D656092S

(12) **United States Design Patent**
Nomi et al.

(10) **Patent No.:** **US D656,092 S**
(45) **Date of Patent:** **** Mar. 20, 2012**

(54) **BATTERY CASE WITH CHARGING FUNCTION**

(75) Inventors: **Takuo Nomi**, Moriguchi (JP); **Motohiro Sasada**, Moriguchi (JP); **Shinji Oda**, Moriguchi (JP)

(73) Assignee: **SANYO Electric Co., Ltd.**, Moriguchi-shi, Osaka (JP)

(**) Term: **14 Years**

(21) Appl. No.: **29/397,546**

(22) Filed: **Jul. 18, 2011**

(30) **Foreign Application Priority Data**

Jan. 17, 2011 (JP) 2011-000736

(51) **LOC (9) Cl.** **13-02**

(52) **U.S. Cl.** **D13/107**

(58) **Field of Classification Search** D13/107-110, D13/118-119, 184, 199; D14/251, 253, D14/432, 434; 320/107-115

See application file for complete search history.

(56) **References Cited**

U.S. PATENT DOCUMENTS

D412,487 S * 8/1999 Nagele et al. D13/108
D483,014 S * 12/2003 Hsiao D13/107

D543,934 S * 6/2007 Kang et al. D13/107
D544,437 S * 6/2007 Hussaini et al. D13/107
D546,281 S * 7/2007 Bell D13/107
D564,960 S * 3/2008 Sacco et al. D13/107
D565,506 S * 4/2008 Sacco et al. D13/107
D572,655 S * 7/2008 Osiecki et al. D13/107
D605,587 S * 12/2009 Nomi et al. D13/107
D615,045 S * 5/2010 Lanfear et al. D13/162
D623,129 S * 9/2010 Kawakami et al. D13/107
D628,201 S * 11/2010 Tian et al. D14/434

* cited by examiner

Primary Examiner — Rosemary K Tarcza

(74) *Attorney, Agent, or Firm* — William F. Westerman

(57) **CLAIM**

An ornamental design for a battery case with charging function, as shown and described.

DESCRIPTION

FIG. 1 is a perspective view of a battery case with charging function, showing our new design; FIG. 2 is a front elevational view thereof; FIG. 3 is a rear elevational view thereof; FIG. 4 is a top plan view thereof; FIG. 5 is a bottom plan view thereof; FIG. 6 is a right side elevational view thereof, the left side elevational view being a mirror image thereof; and, FIG. 7 is a perspective view showing the bottom thereof.

1 Claim, 6 Drawing Sheets

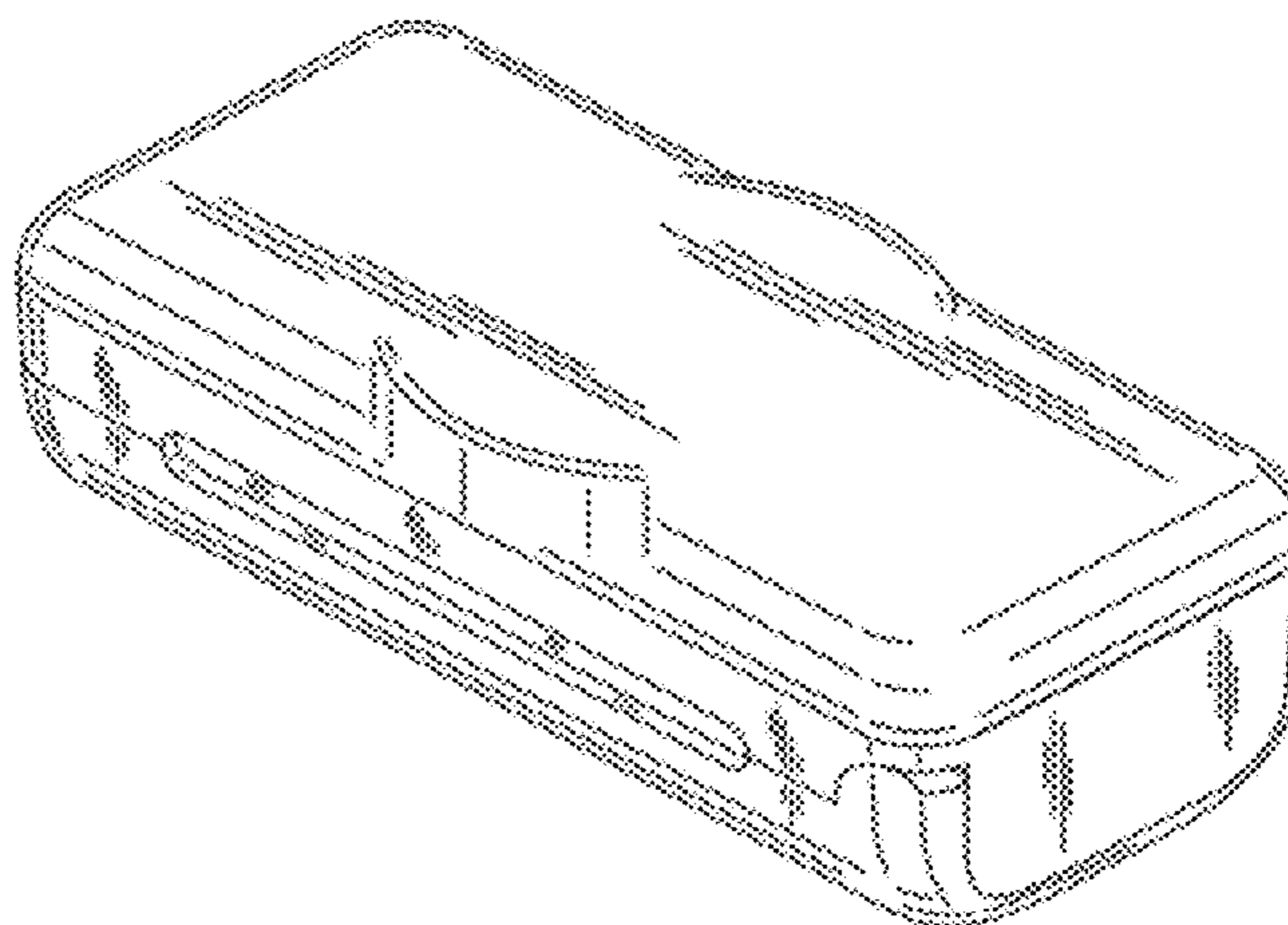
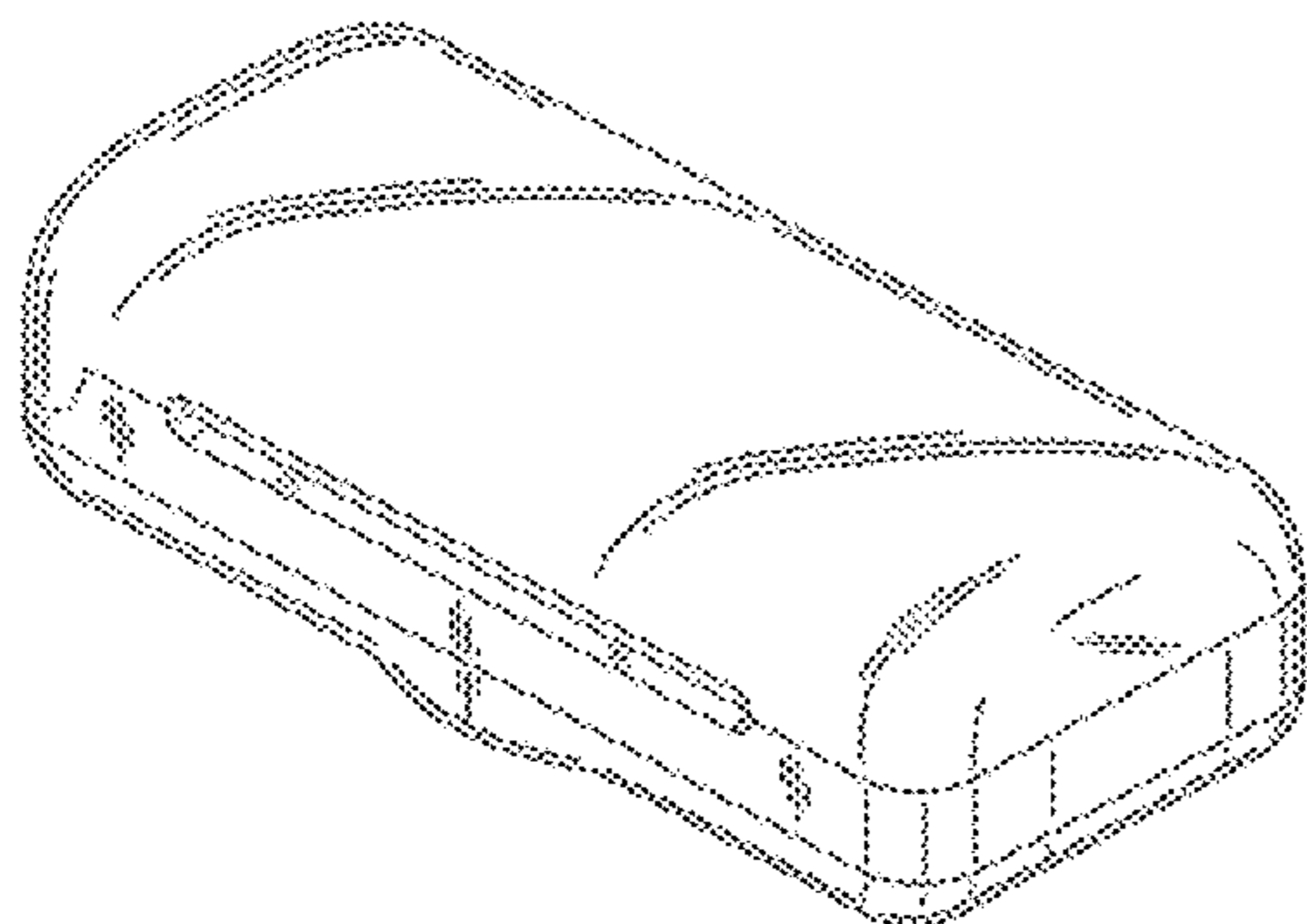

FIG. 1

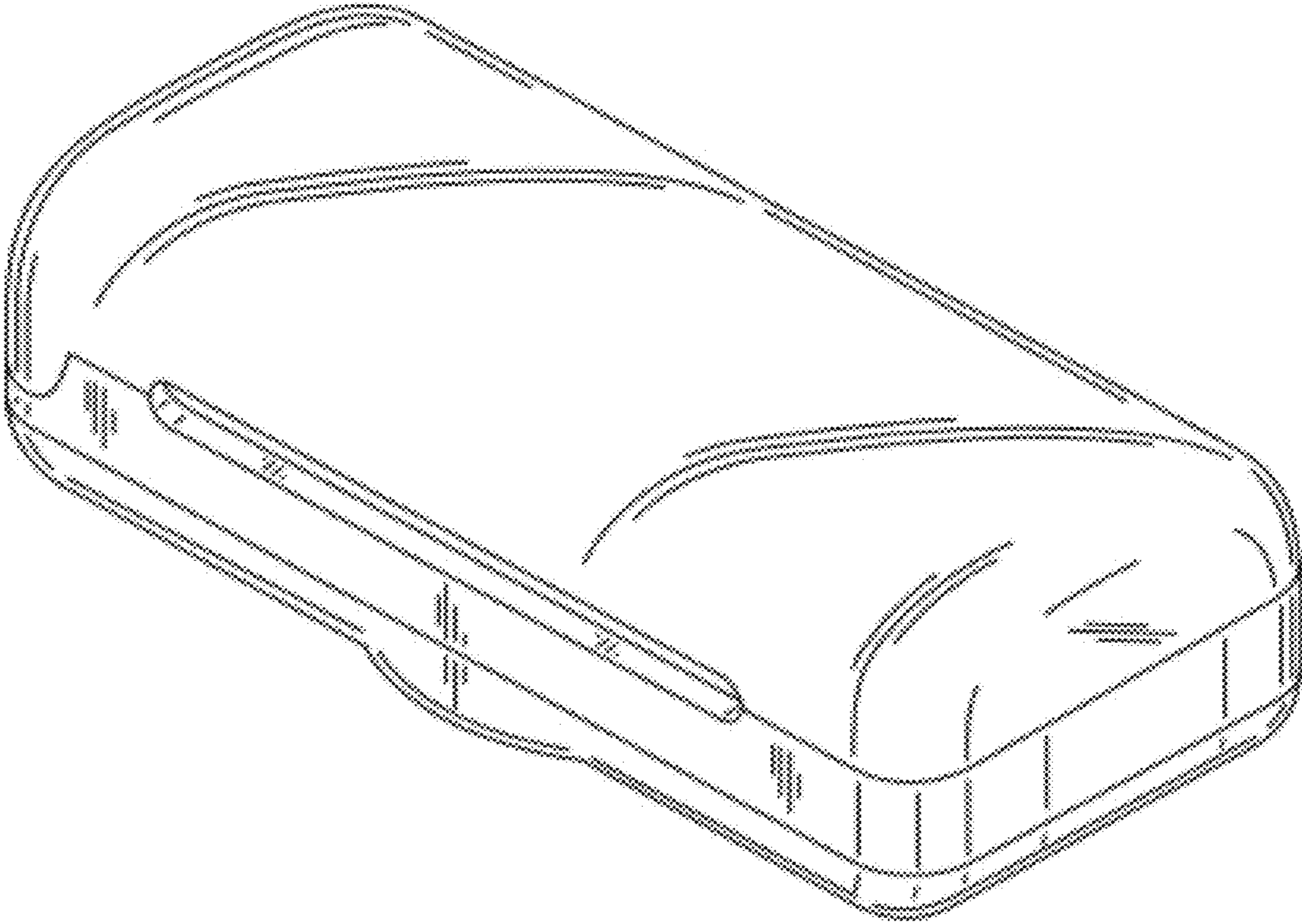

FIG.2

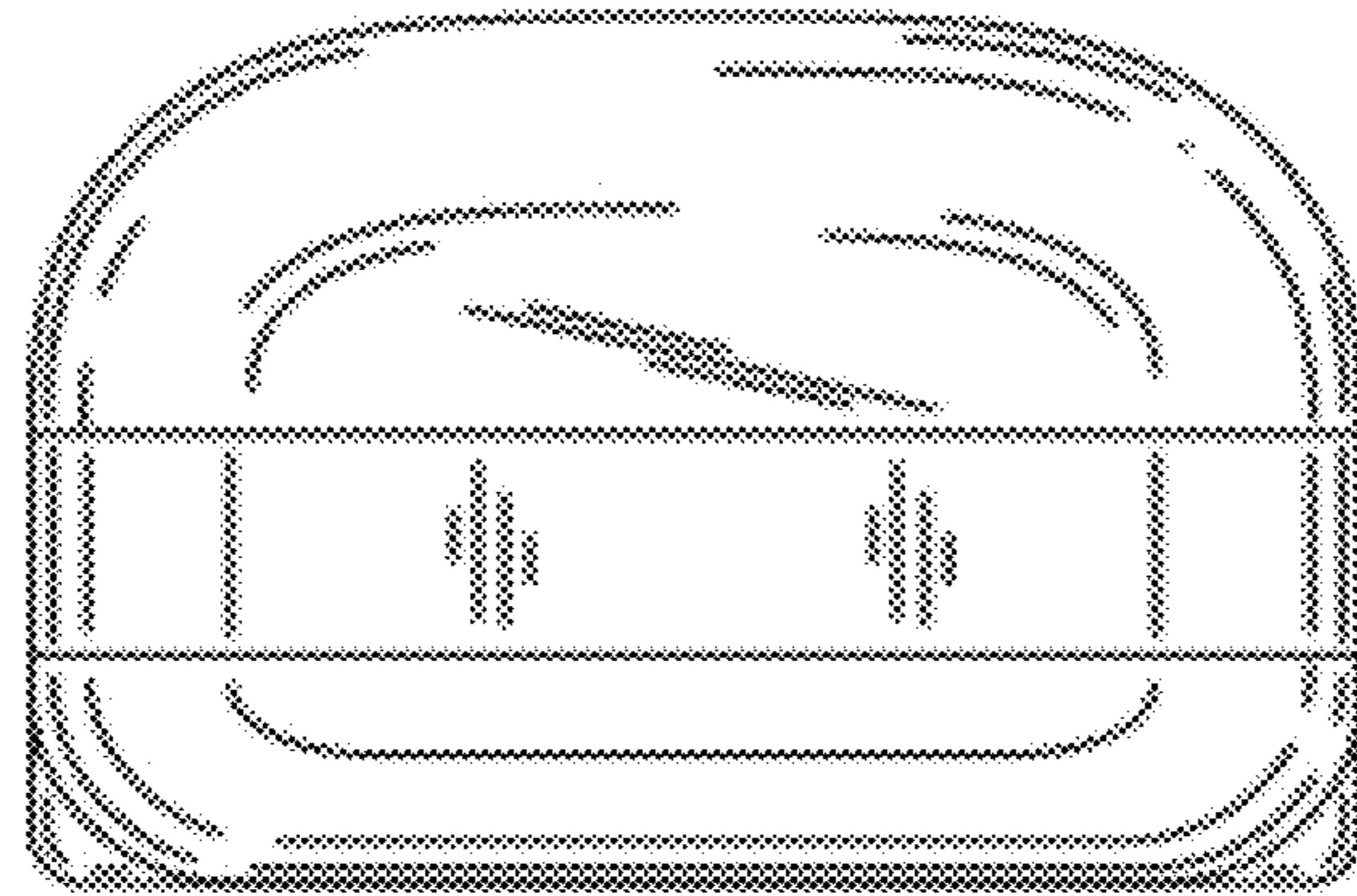

FIG.3

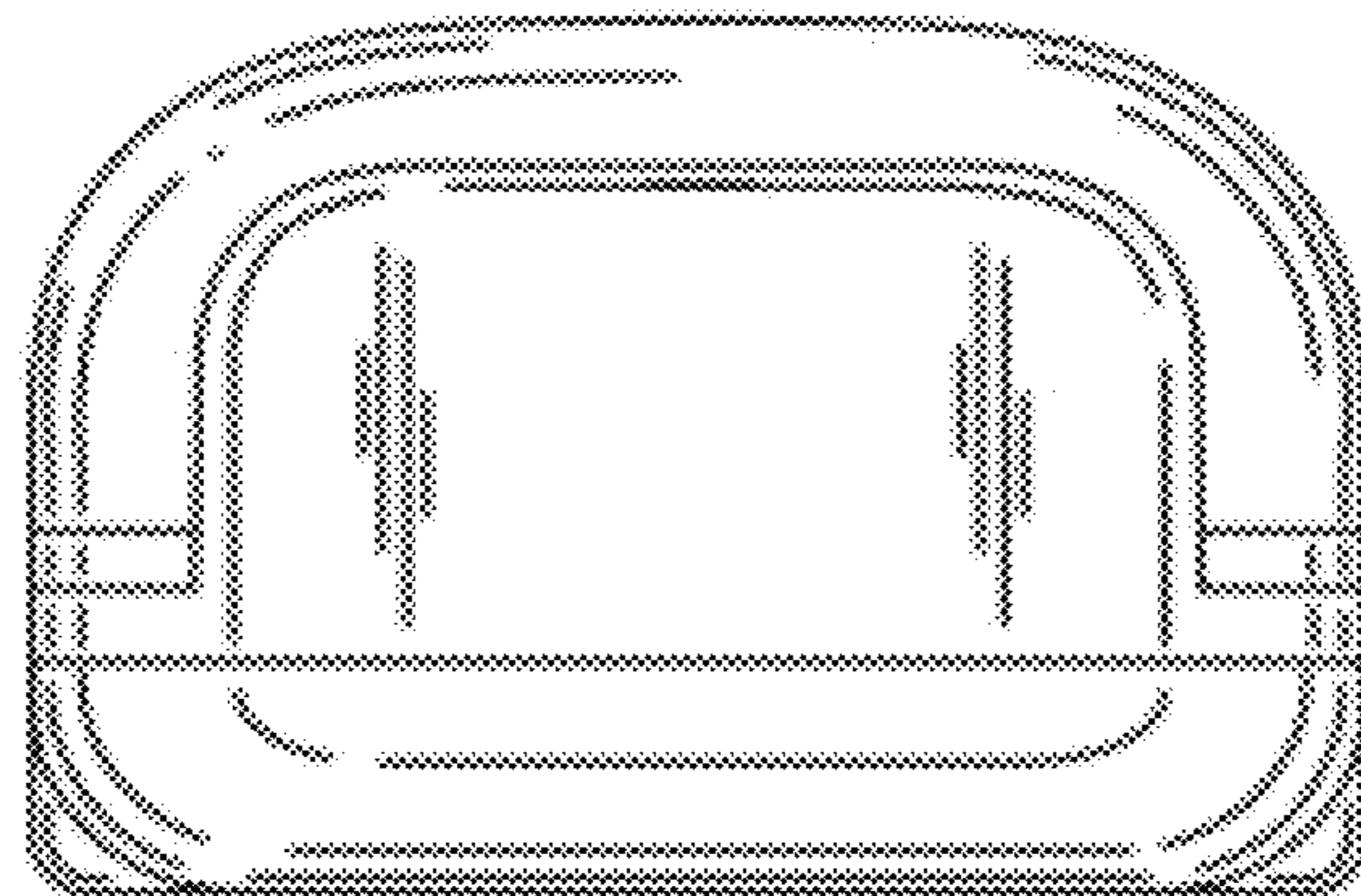

FIG.4

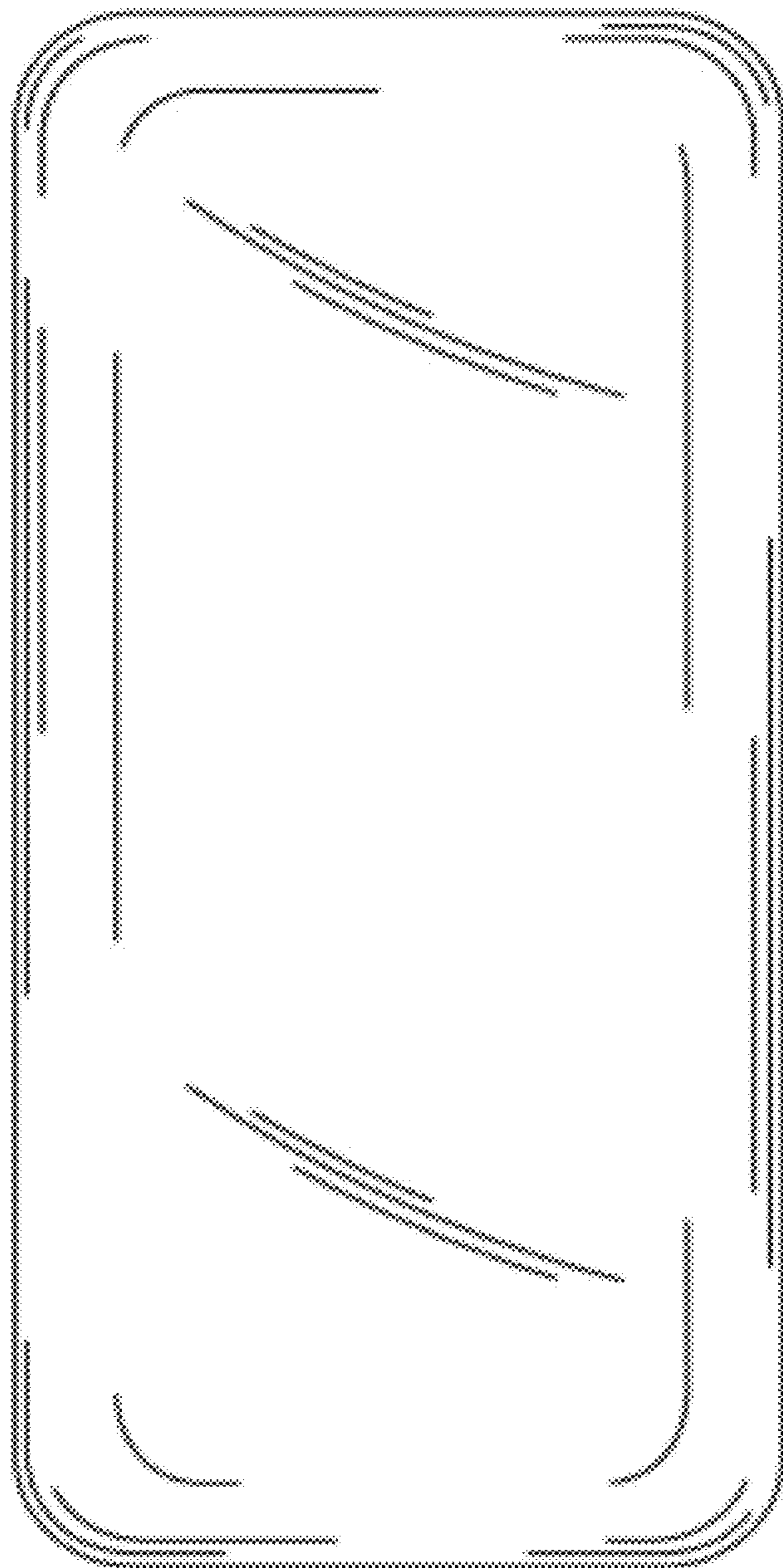

FIG. 5

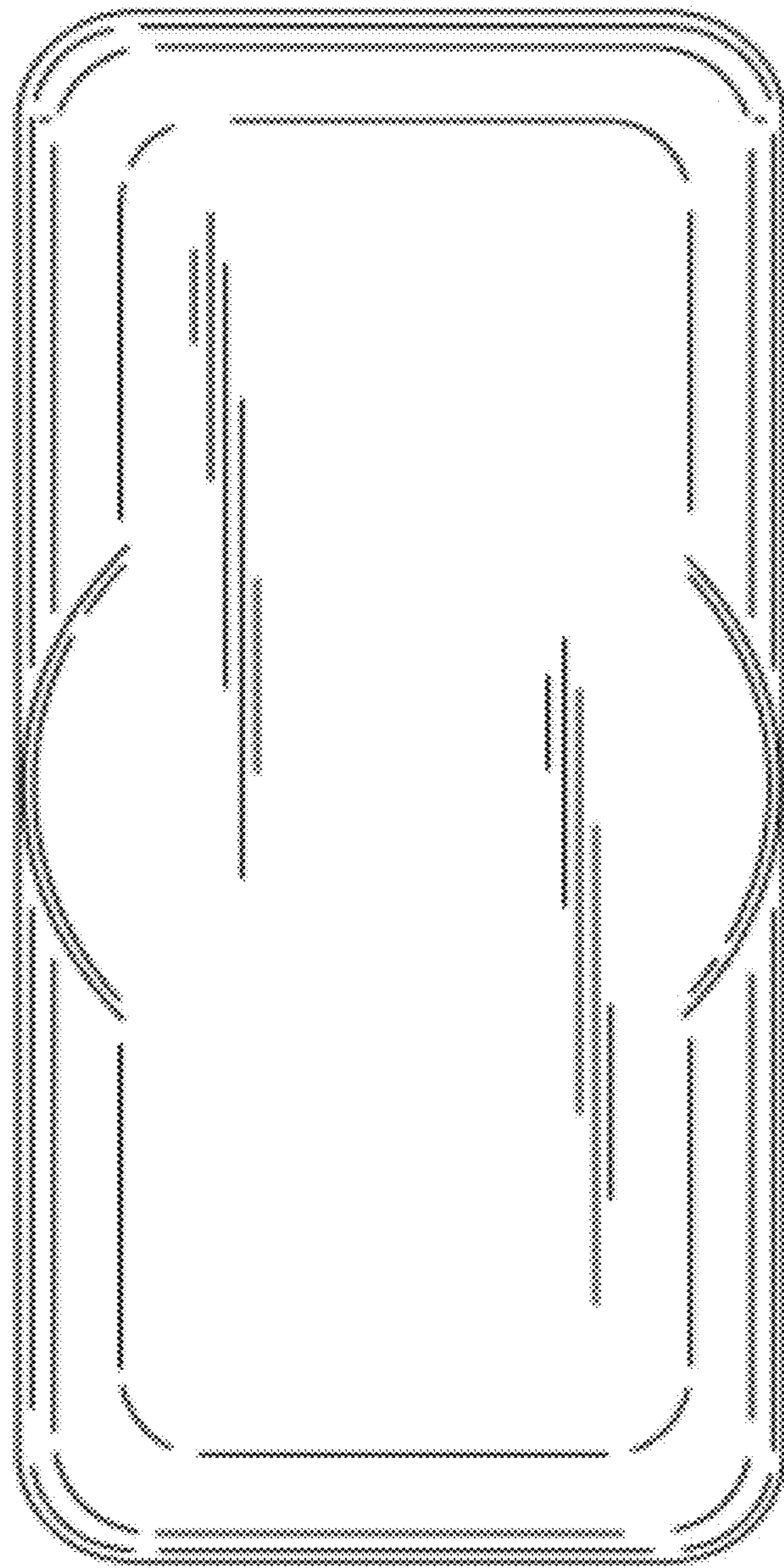

FIG. 6

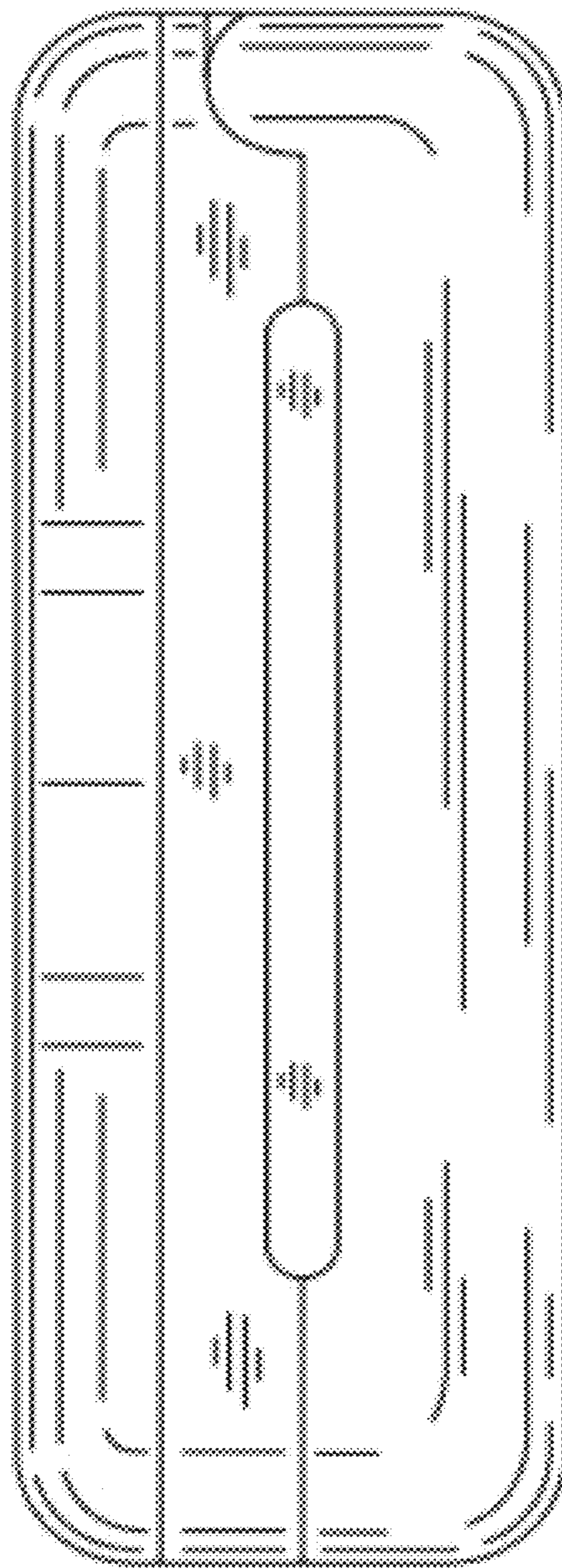

FIG. 7

