



US00D656012S

(12) **United States Design Patent**  
**Leu et al.**

(10) **Patent No.:** **US D656,012 S**  
(45) **Date of Patent:** **\*\* Mar. 20, 2012**

(54) **CIRCLE TAG FOR A BOTTLE OR SIMILAR ARTICLE**

(76) Inventors: **Kristin Leu**, New York, NY (US);  
**Jennifer Simoni**, Hoboken, NJ (US)

(\*\*) Term: **14 Years**

(21) Appl. No.: **29/361,955**

(22) Filed: **May 18, 2010**

(51) **LOC (9) Cl.** ..... **09-07**

(52) **U.S. Cl.** ..... **D9/434; D20/28**

(58) **Field of Classification Search** ..... D9/713,  
D9/516, 457, 456, 447, 444, 443, 436, 435,  
D9/434; D20/40, 28, 27, 22; D11/3; 40/633,  
40/321, 313, 312, 310, 124.04; 220/694;  
215/386

See application file for complete search history.

(56) **References Cited**

U.S. PATENT DOCUMENTS

478,938	A *	7/1892	Moore	40/309
1,151,940	A *	8/1915	Gauvreau	40/633
1,460,641	A *	7/1923	Broome	40/321
1,477,144	A *	12/1923	Malocsay	40/321
D128,682	S *	8/1941	Reinstein	D11/74
D134,335	S *	11/1942	McVay	D9/457
4,745,696	A *	5/1988	Scouten	40/309
5,358,770	A *	10/1994	Evans	428/99
D386,211	S *	11/1997	Taparauskas, Jr.	D20/22
5,800,881	A *	9/1998	Etzion	428/5
D405,692	S *	2/1999	Johnson	D9/443

D466,339	S *	12/2002	Risdon	D6/491
D554,191	S *	10/2007	Johnson	D20/28
D561,059	S *	2/2008	Aoyama	D11/119
D611,545	S *	3/2010	Williams	D20/28

\* cited by examiner

*Primary Examiner* — Susan Bennett Hattan

(74) *Attorney, Agent, or Firm* — Powley & Gibson, P.C.

(57) **CLAIM**

We claim the ornamental design for a circle tag for a bottle or similar article, as shown and described.

**DESCRIPTION**

FIG. 1 is a perspective view of the circle tag for a bottle or similar article, showing our new design in full lines; FIG. 2 is a front view of the circle tag in full lines; FIG. 3 is a rear view of the circle tag in full lines; FIG. 4 is a right side view of the circle tag in full lines; FIG. 5 is a left side view of the circle tag in full lines; FIG. 6 is a top view of the circle tag in full lines; FIG. 7 is a bottom view of the circle tag in full lines; FIG. 8 is a top view of the circle tag in full lines; FIG. 9 is a front view of the circle tag in full lines; and, FIG. 10 is a right side view of the circle tag in full lines.

The break in the ribbon indicates that the ribbon is of no particular length. The broken lines shown on the ribbon indicate that the ribbon is of no particular width. The broken lines showing wording on the circle tag and showing a bottle illustrate portions of the design or environmental matter that form no part of the claim.

**1 Claim, 7 Drawing Sheets**

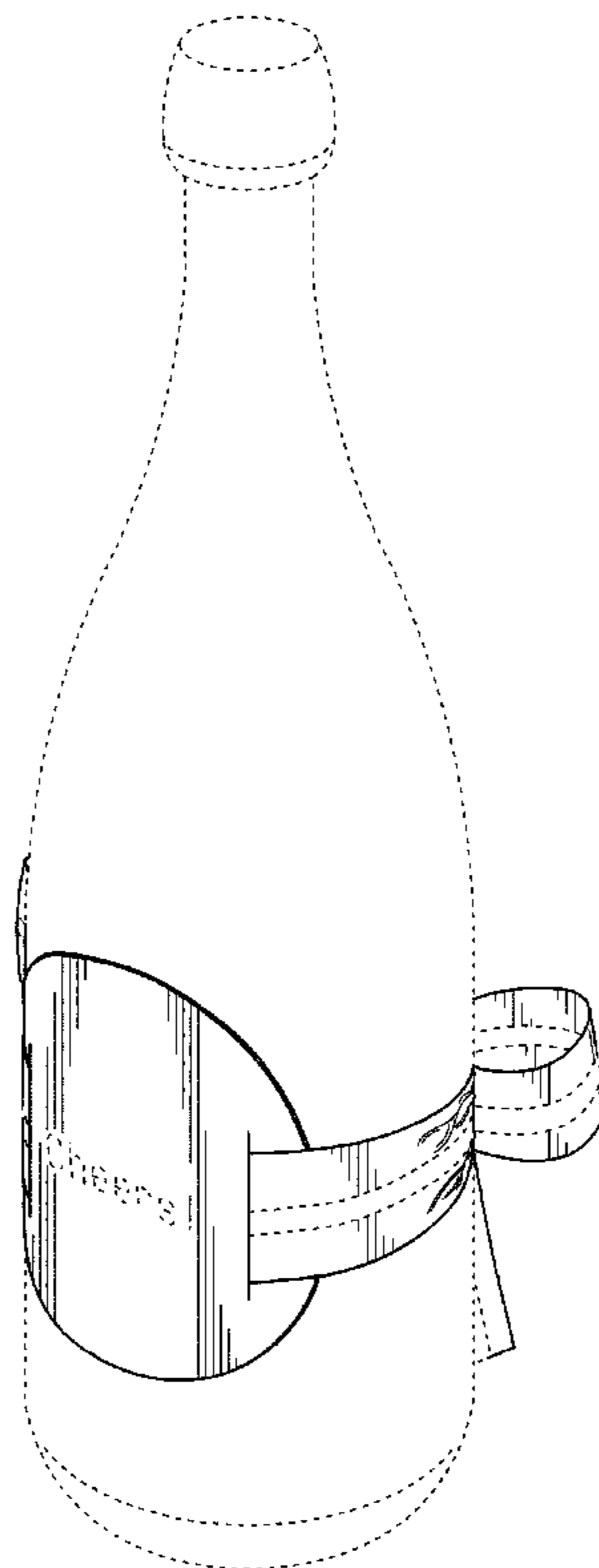

FIG. 1

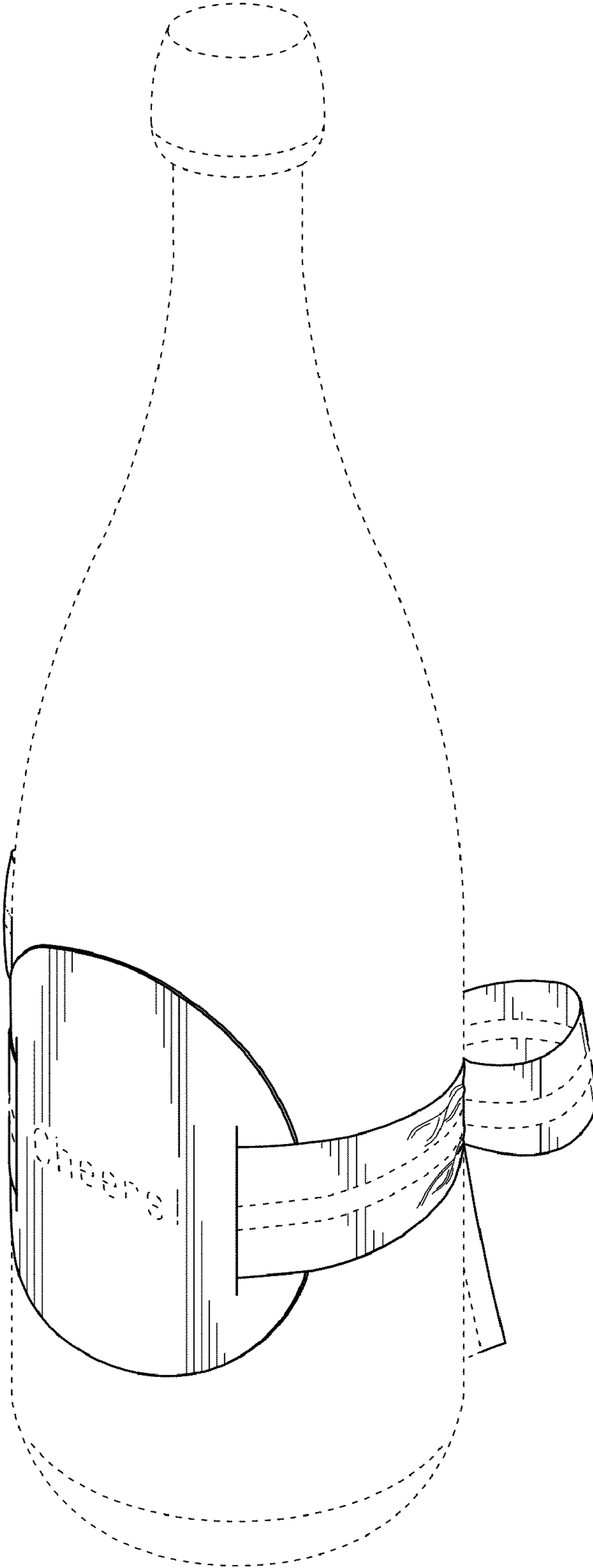
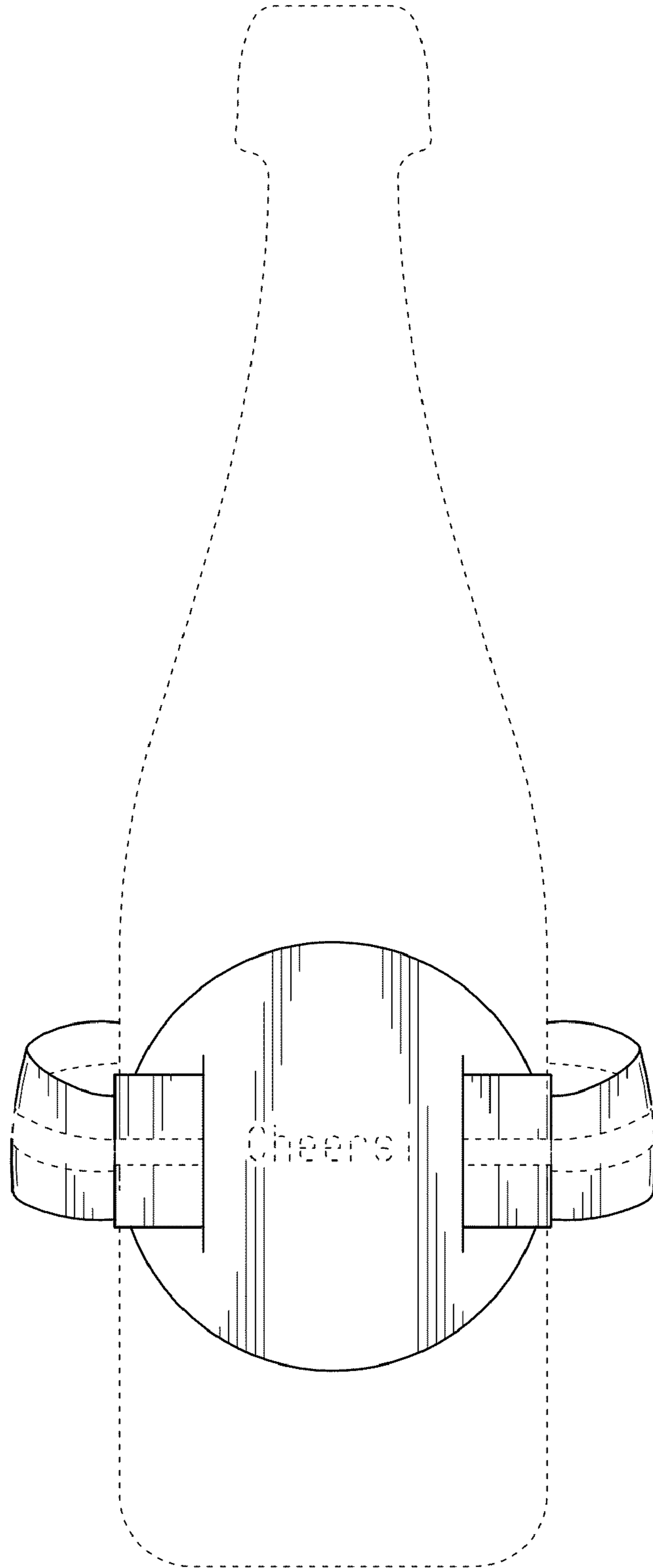

FIG. 2



*FIG. 3*

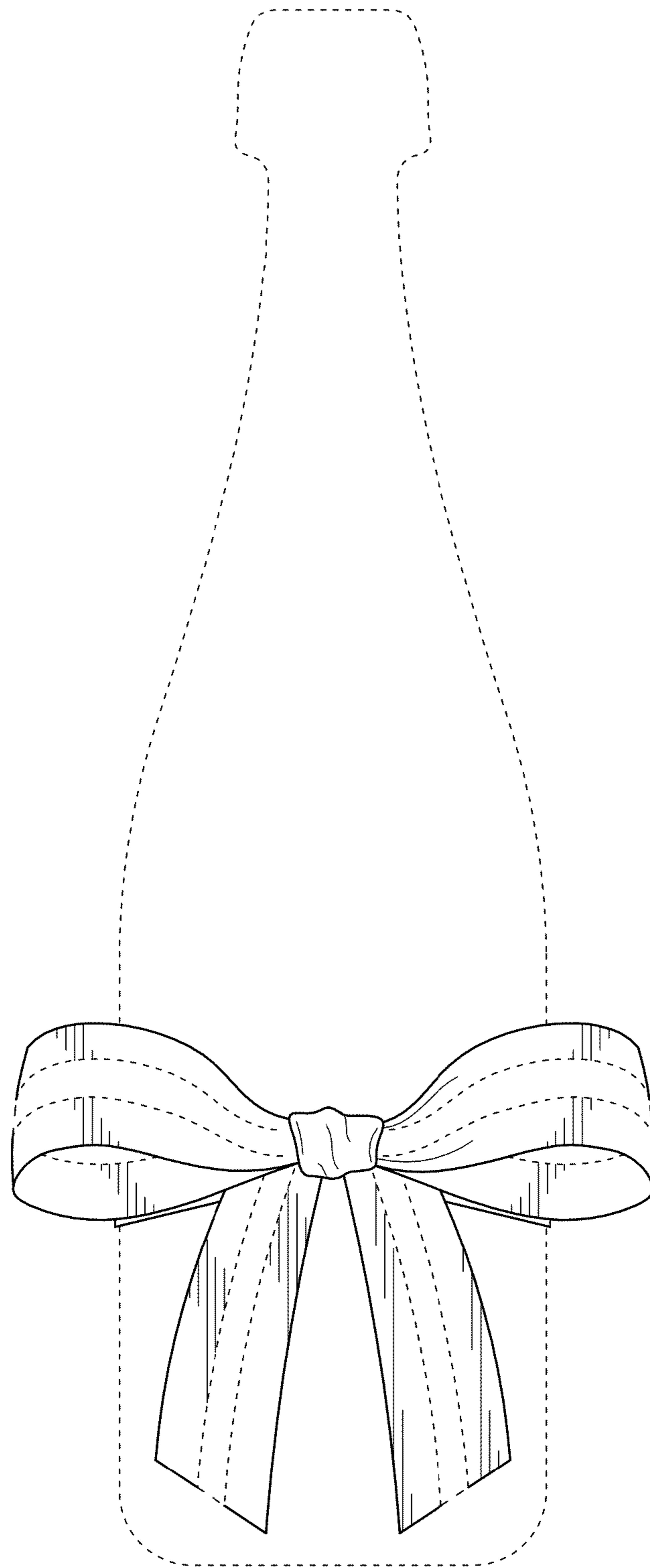

FIG. 4

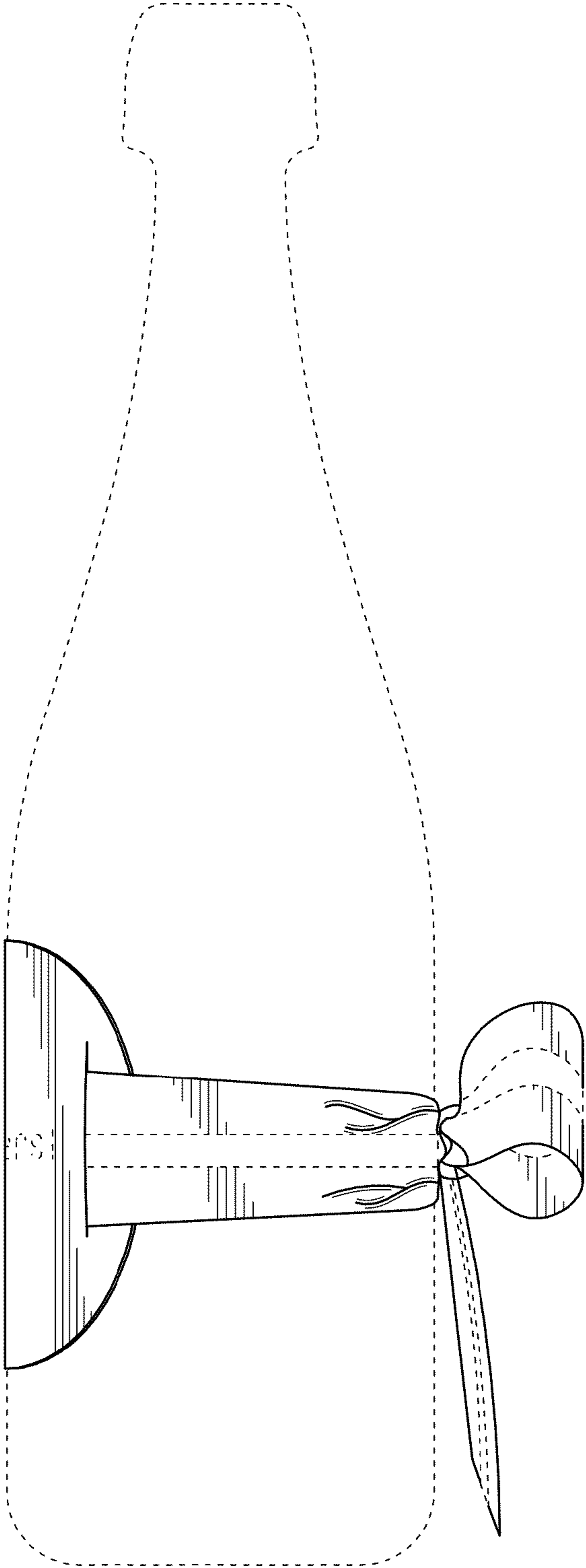
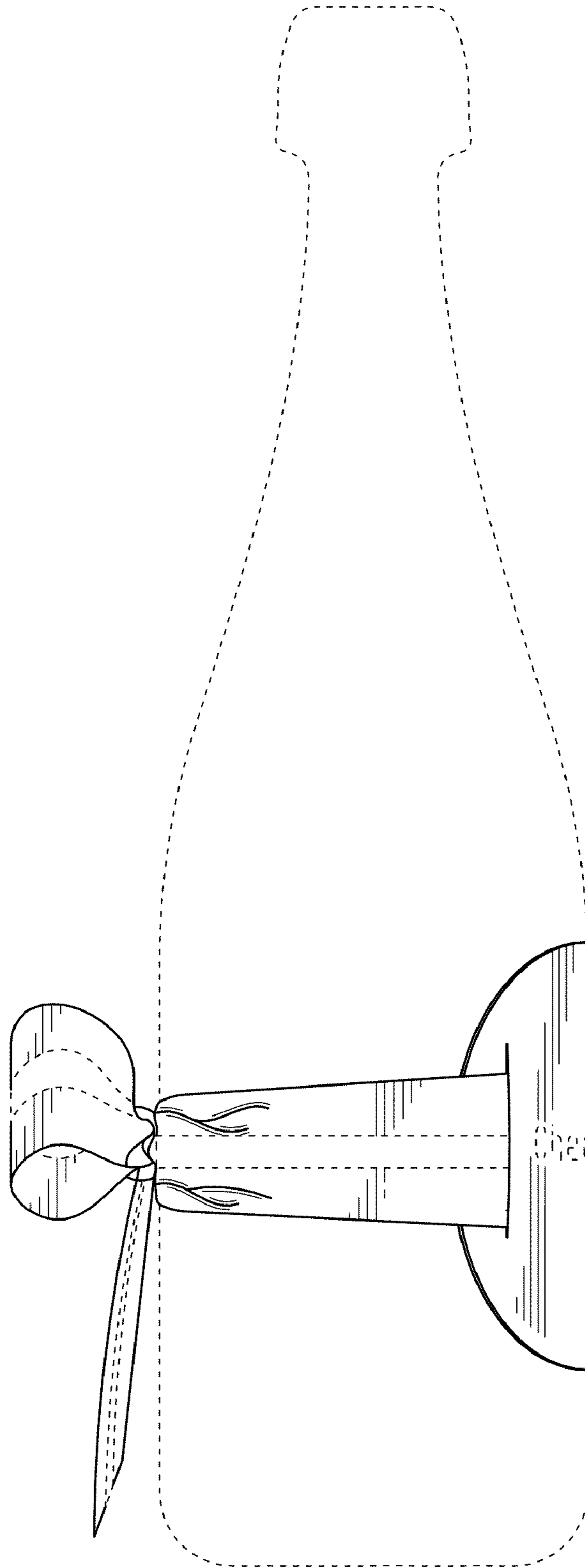
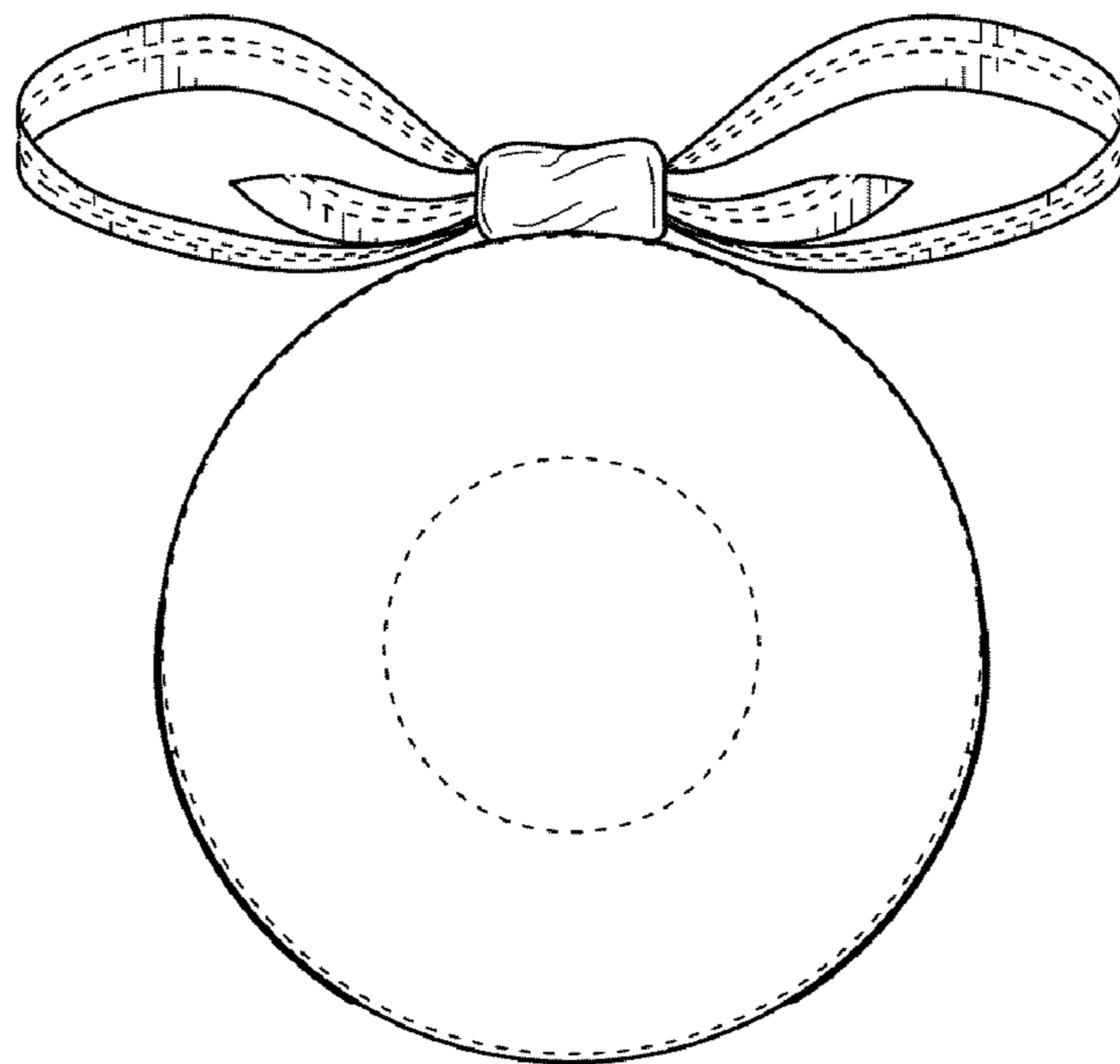

FIG. 5



*FIG. 6*



*FIG. 7*

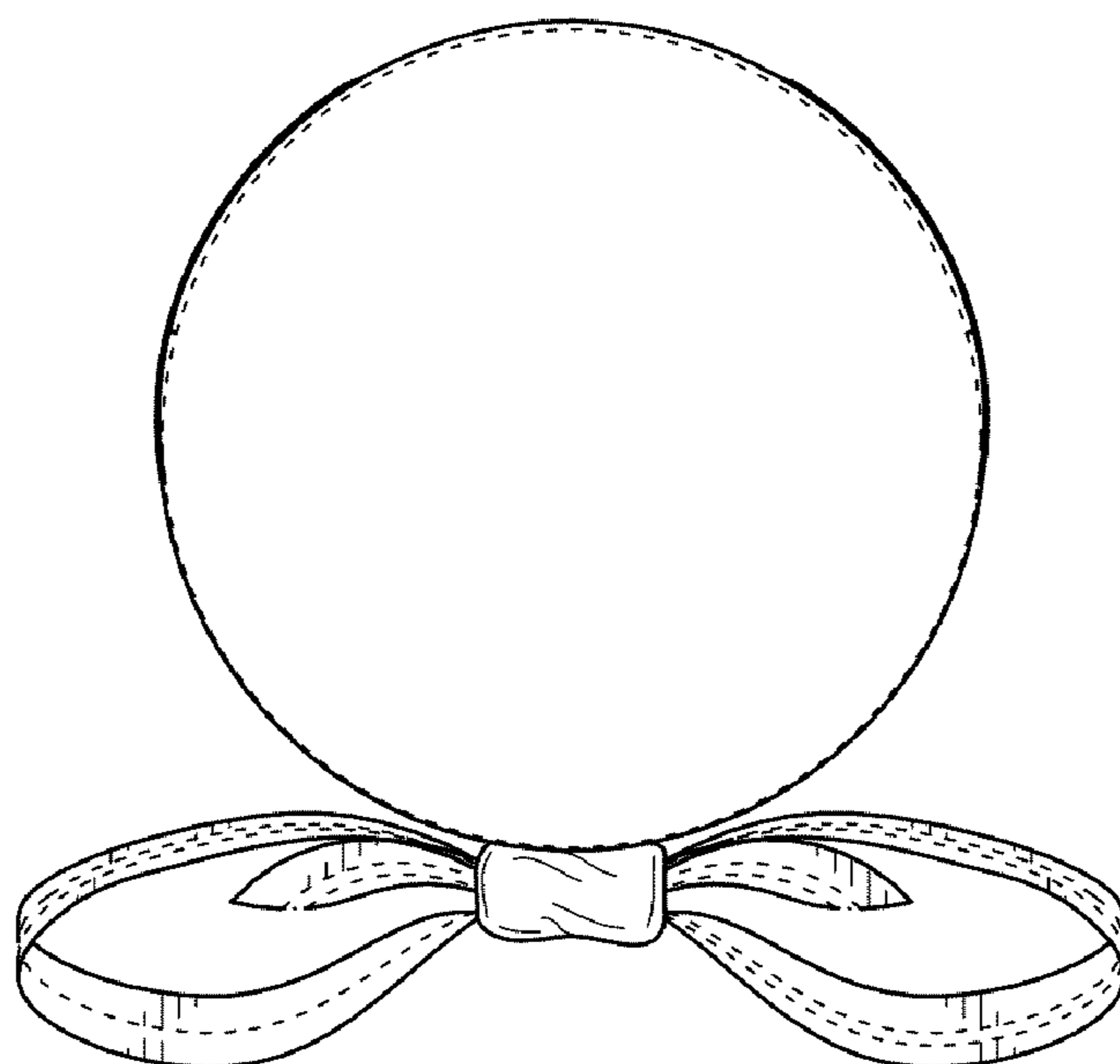

FIG. 8

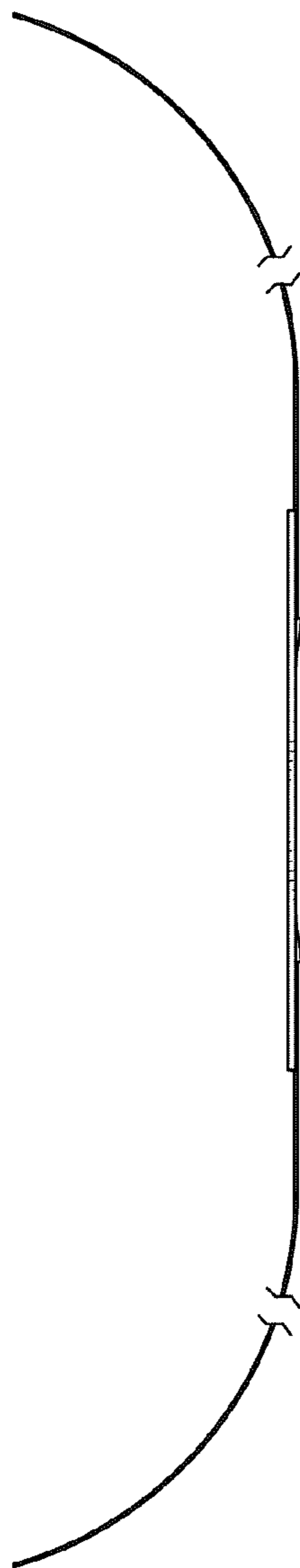

FIG. 9

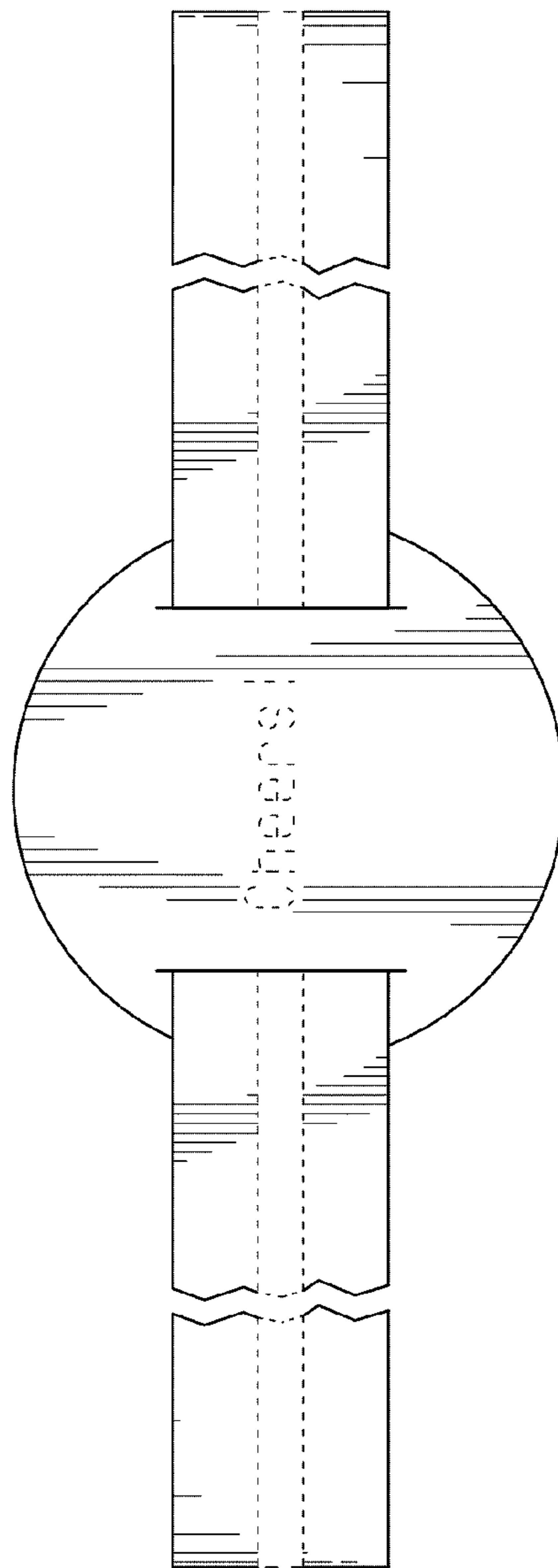

FIG. 10

