



US00D655955S

(12) **United States Design Patent**
Kluck et al.

(10) **Patent No.:** **US D655,955 S**
(45) **Date of Patent:** **** Mar. 20, 2012**

(54) **DISPENSER**

(75) Inventors: **Scott M. Kluck**, Mequon, WI (US);
Mark A. Meyer, Slinger, WI (US)

(73) Assignee: **Bradley Corporation**, Menomonee Falls, WI (US)

(**) Term: **14 Years**

(21) Appl. No.: **29/385,922**

(22) Filed: **Feb. 22, 2011**

Related U.S. Application Data

(63) Continuation-in-part of application No. 29/379,126, filed on Nov. 15, 2010.

(51) **LOC (9) Cl.** **20-02**

(52) **U.S. Cl.** **D6/515**

(58) **Field of Classification Search** D6/515-523;
206/225, 233, 389, 391; 211/13.1; 222/173,
222/180; 221/26, 33, 282-283, 61; 242/270,
242/590; 248/309.1, 309.2, 905; 225/106
See application file for complete search history.

(56) **References Cited**

U.S. PATENT DOCUMENTS

4,617,655	A	10/1986	Aldenhoven
4,707,933	A	11/1987	Keck et al.
4,949,877	A	8/1990	Hanna et al.
4,964,544	A	10/1990	Hanna et al.
D332,194	S	1/1993	Hines
D332,195	S	1/1993	Hines
D332,196	S	1/1993	Hines
D332,365	S	1/1993	Hines
D332,542	S	1/1993	Hines
D332,679	S	1/1993	Hines

D332,849	S	1/1993	Hines
D334,266	S	3/1993	Hines
5,226,625	A	7/1993	Hanna
D338,361	S	8/1993	Hines
D340,374	S	10/1993	Hines
D341,724	S	11/1993	Hines
5,261,619	A	11/1993	Merriweather

(Continued)

OTHER PUBLICATIONS

Big Willy Toilet Paper Dispenser, believed to have been publicly available before Nov. 15, 2010, 1 page.

(Continued)

Primary Examiner — Brian N Vinson

(74) *Attorney, Agent, or Firm* — Foley & Lardner LLP

(57) **CLAIM**

We claim the ornamental design for a dispenser, as shown and described.

DESCRIPTION

FIG. 1 is a perspective view from above of a dispenser showing my new design;

FIG. 2 is a second perspective view from above of the claimed design of FIG. 1;

FIG. 3 is a front view of the claimed design of FIG. 1;

FIG. 4 is a rear view of the claimed design of FIG. 1;

FIG. 5 is a left side view of the claimed design of FIG. 1;

FIG. 6 is a right side view of the claimed design of FIG. 1;

FIG. 7 is a top view of the claimed design of FIG. 1; and,

FIG. 8 is a bottom view of the claimed design of FIG. 1.

The ornamental design which is claimed is shown in solid lines in the drawings. The broken lines in the drawings are for illustrative purposes only and form no part of the claimed design.

1 Claim, 8 Drawing Sheets

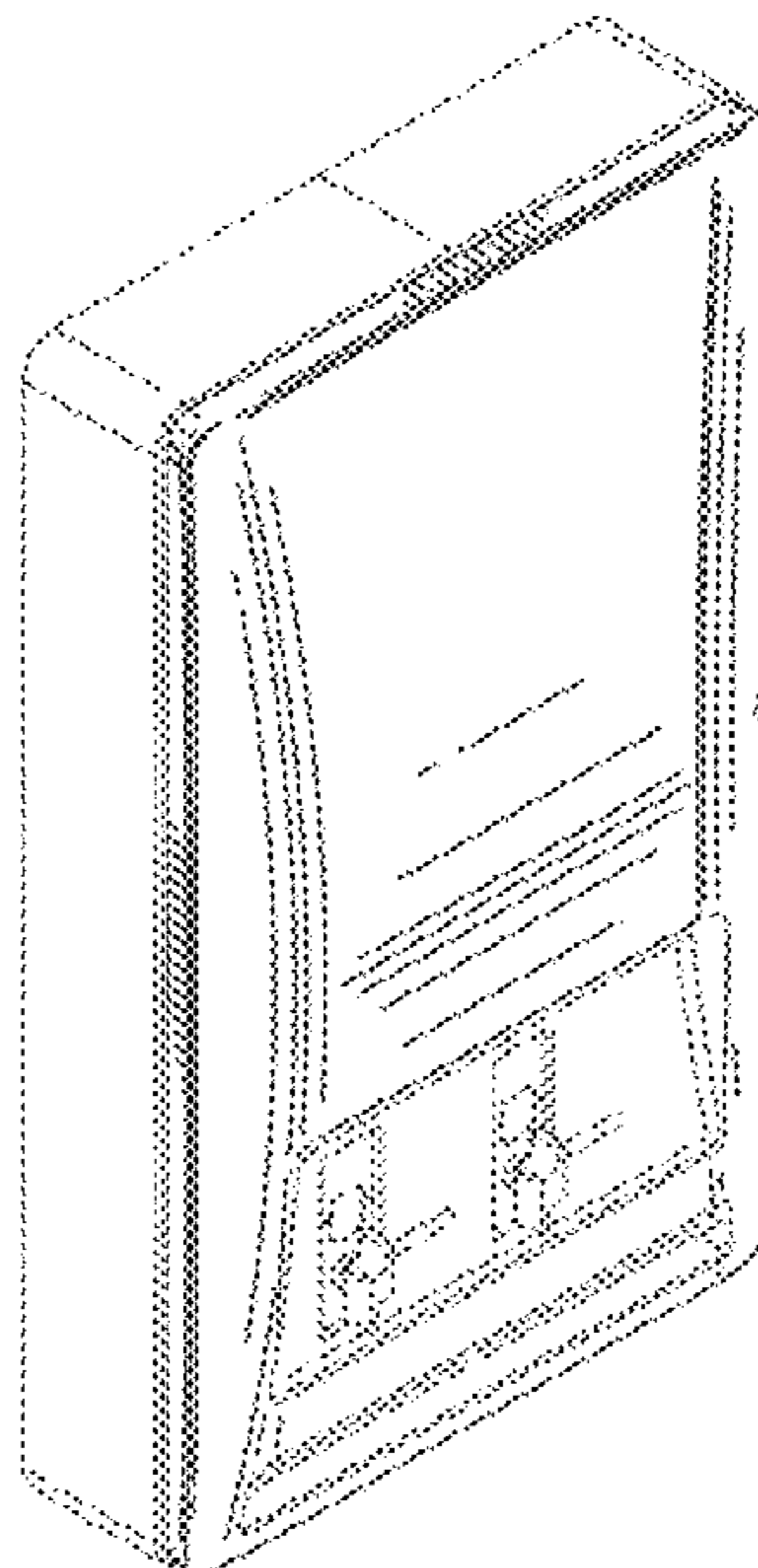

U.S. PATENT DOCUMENTS

D342,175	S	12/1993	Hines	
5,605,265	A	2/1997	Hanna	
D385,445	S	10/1997	Arbak et al.	
D401,708	S	11/1998	Arbak et al.	
5,957,324	A	9/1999	Gettelman et al.	
D416,726	S	11/1999	Kurti et al.	
5,988,451	A	11/1999	Hanna	
D426,412	S	6/2000	Cameron	
6,119,901	A	9/2000	Hanna et al.	
6,129,245	A	10/2000	Redman et al.	
6,131,771	A	10/2000	Hanna	
6,276,027	B1	8/2001	Hanna	
6,502,721	B2	1/2003	Redman et al.	
D482,221	S *	11/2003	Phelps et al.	D6/518
D493,312	S *	7/2004	Collins et al.	D6/518
D520,277	S *	5/2006	Smiley et al.	D6/518
D522,781	S *	6/2006	Wieser et al.	D6/518
D546,081	S	7/2007	Babikian et al.	
D553,402	S *	10/2007	Orgna et al.	D6/518
D564,267	S *	3/2008	Tomic et al.	D6/518
D579,249	S *	10/2008	Omdoll et al.	D6/518
D594,754	S *	6/2009	Dretzka	D6/518
D598,687	S *	8/2009	Serfaty	D6/518
D620,290	S *	7/2010	Herrera	D6/518
D621,644	S *	8/2010	Johnson	D6/515
D623,453	S *	9/2010	Benedetti	D6/518
D648,585	S *	11/2011	Meyerhoffer	D6/518
D650,622	S *	12/2011	Morand	D6/518
2002/0100771	A1	8/2002	Redman et al.	
2003/0071074	A1	4/2003	Redman et al.	
2004/0164093	A1	8/2004	Redman et al.	
2005/0133529	A1	6/2005	Redman et al.	
2007/0023565	A1	2/2007	Babikian et al.	

2007/0075579	A1	4/2007	Babikian et al.
2007/0151980	A1	7/2007	Babikian et al.
2008/0251528	A1	10/2008	Babikian et al.

OTHER PUBLICATIONS

Columbia Accessories: A Division of PPSiSC, 2009 Washroom Accessories Catalog, <http://www.ppsisc.com/catalogs/acc.pdf>, Accessed Mar. 3, 2011, 2 pages.

Durchdacht bis ins Detail, Photos of Trash Receptacle, Paper Towel Dispenser, Toilet Paper Dispenser, Soap Dispenser, believed to have been publicly available before Nov. 15, 2010, 2 pages.

Ille Folded Paper and Soap Dispenser, believed to have been publicly available before Nov. 15, 2010, 1 page.

Palmer Fixture, Blustorm Hands Free High Speed Dryer, Hands-Free Universal Roll Towel Dispensers, <http://palmerfixture.com/product.php?id=194492>, Accessed Jul. 15, 2009, 1 page.

Palmer Fixture, Soap Dispenser Bulk Electronic SE800, <http://www.palmerfixture.com/product.php?id=191859>, Accessed Jul. 15, 2009, 1 page.

Paper Towel Dispenser and Tissue Dispenser, ABS Plastic, http://www.allproducts.com/household/fanda/16-pull_towel_dispenser.html, Accessed Jul. 15, 2009, 1 page.

Pro Cleaning Solutions: Paper Products: Sofpull Centrepull Towel Di, <http://procleaning.com/xcart/product.php?productid=176&cat=3&page=5>, Accessed Jul. 15, 2009, 1 page.

The Royal Connection, American Specialties, Inc., bearing a designation, © 2009, 8 pages.

Washroom Accessories Bobrick Color Catalog, believed to have been publicly available before Nov. 15, 2010. 52 pages.

* cited by examiner

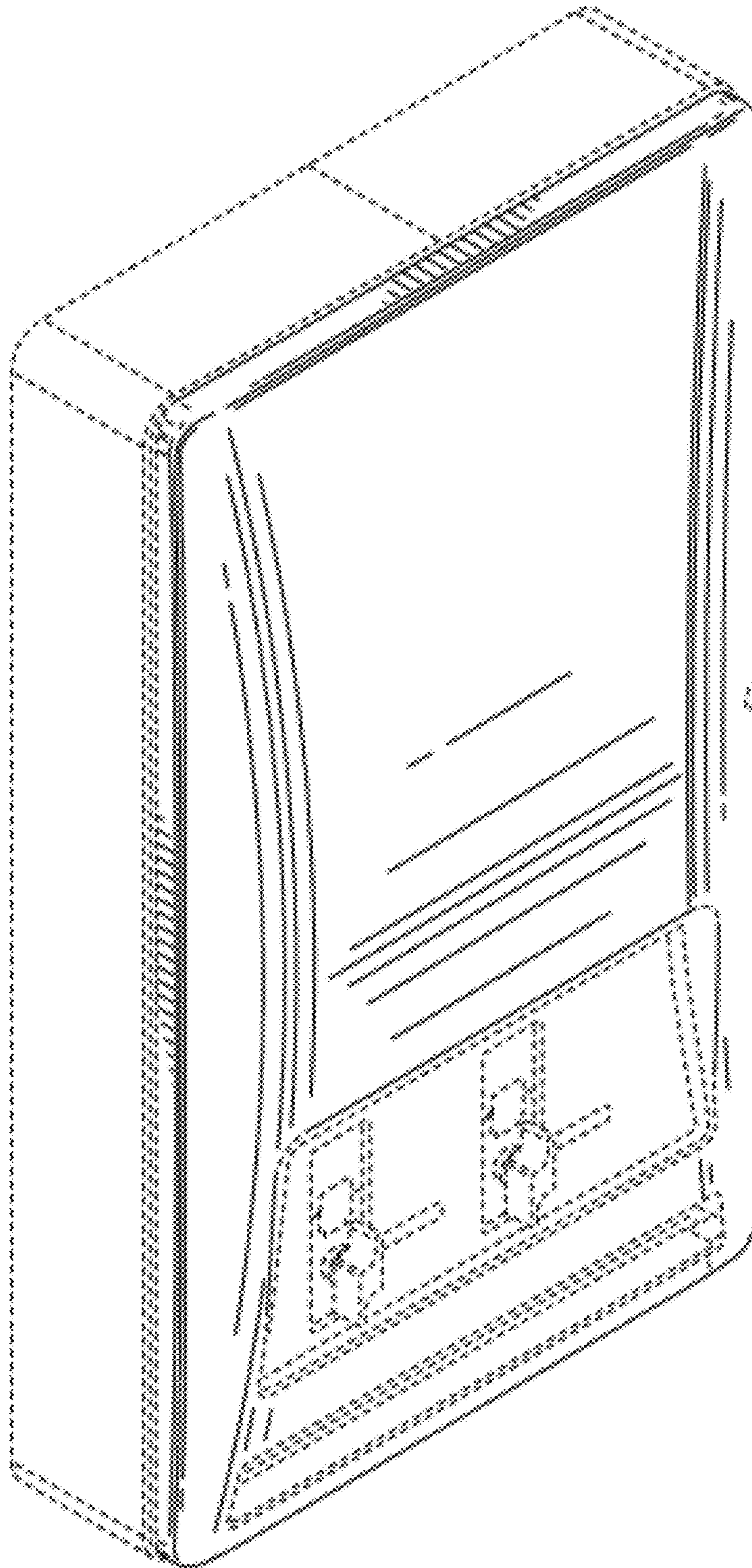

FIG. 1

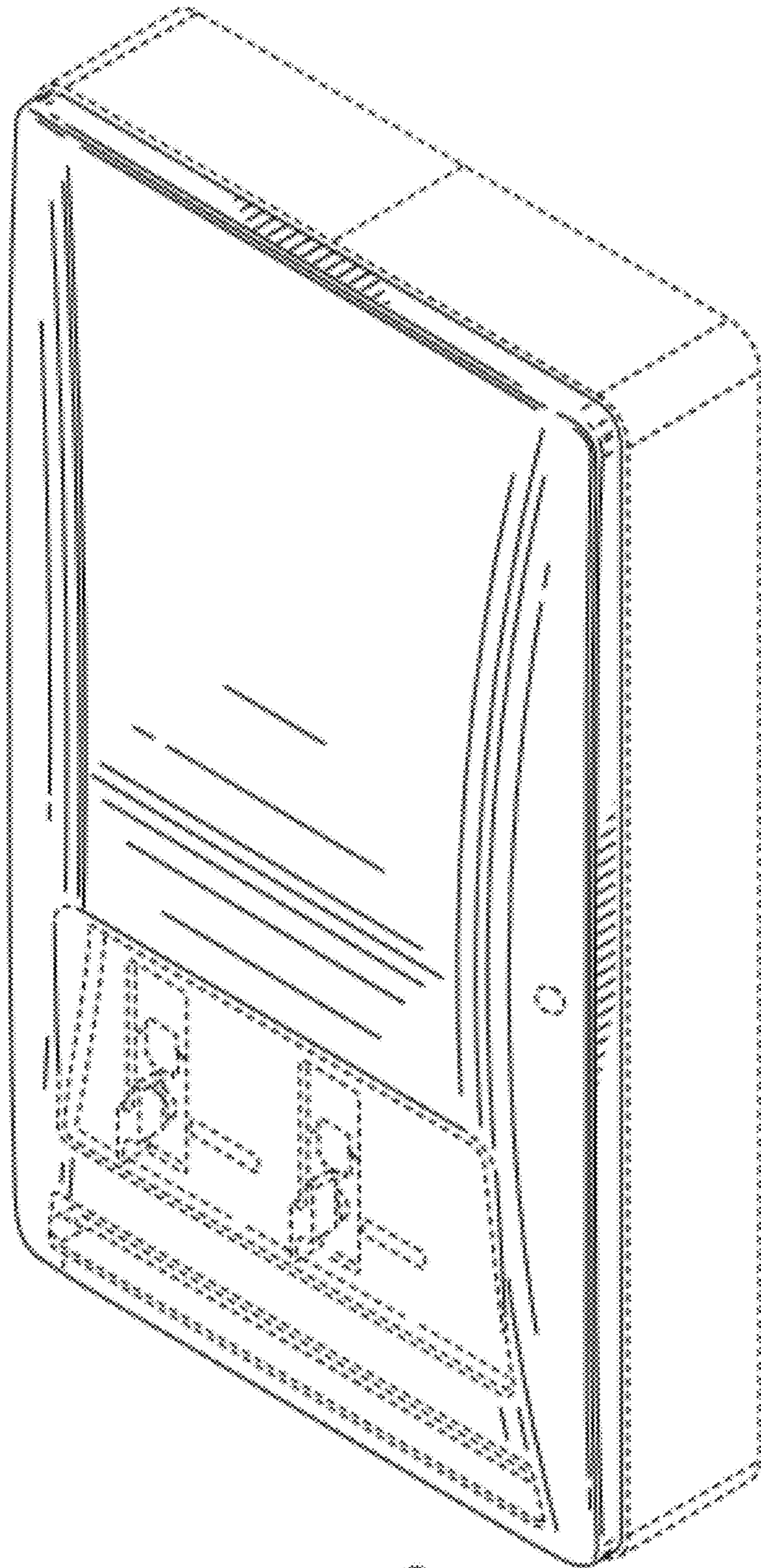

FIG. 2

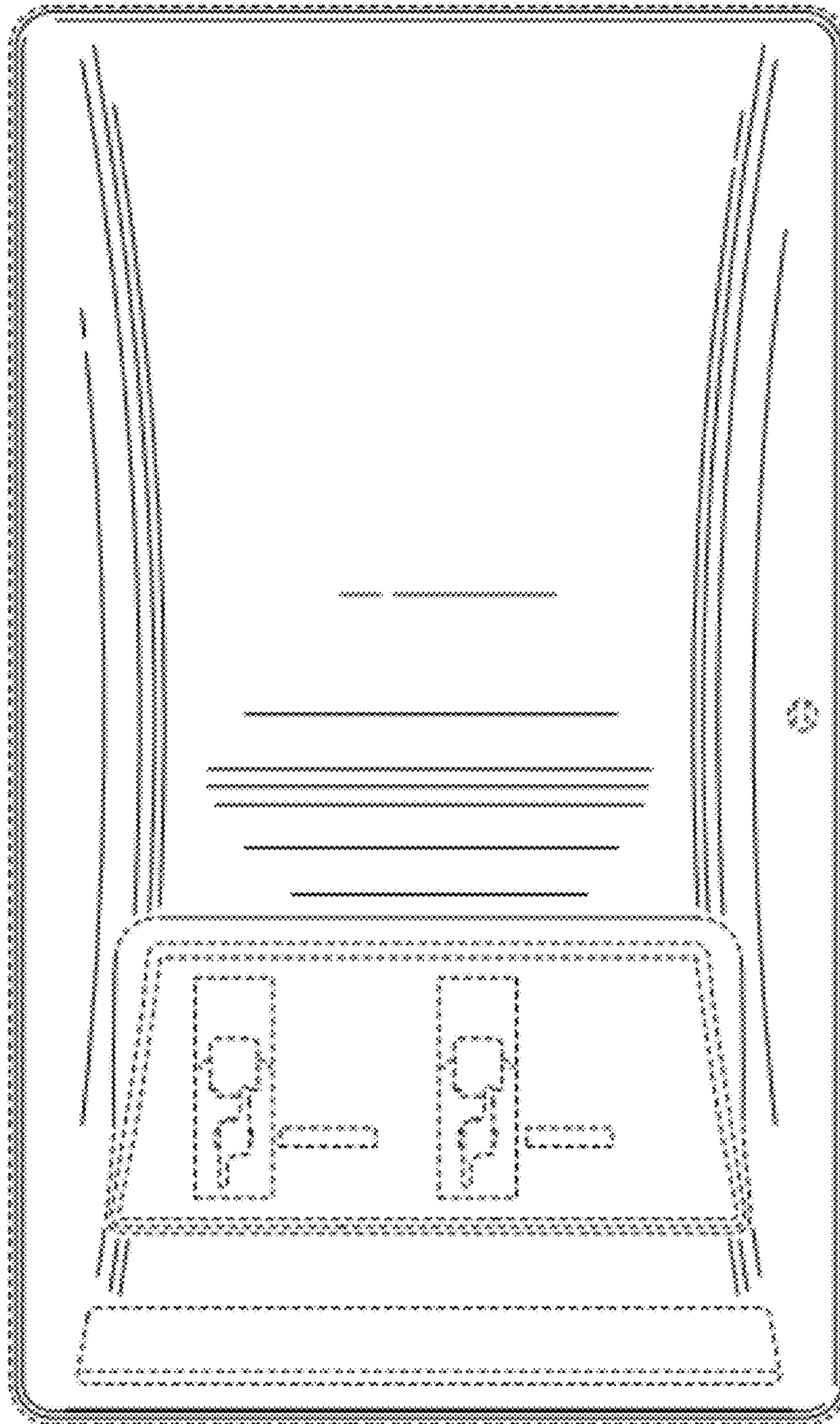

FIG. 3



FIG. 4

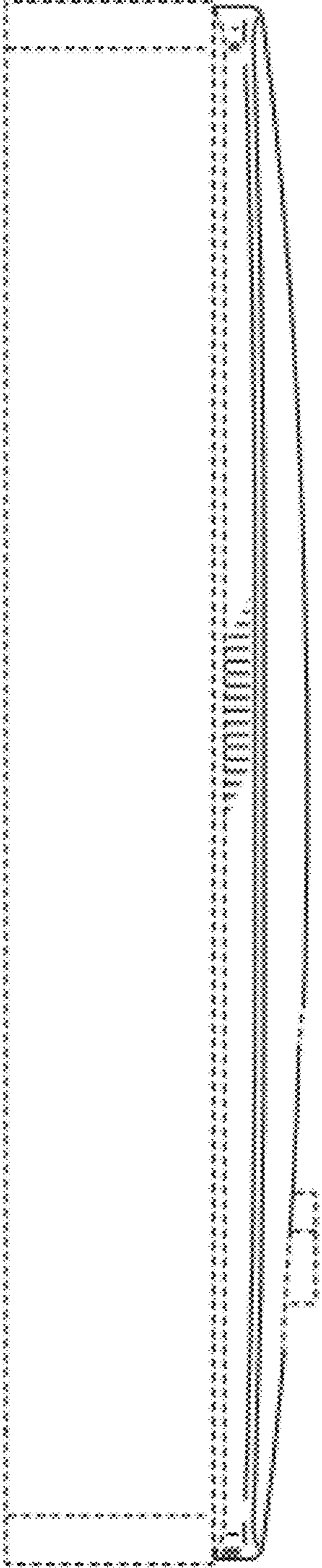

FIG. 5

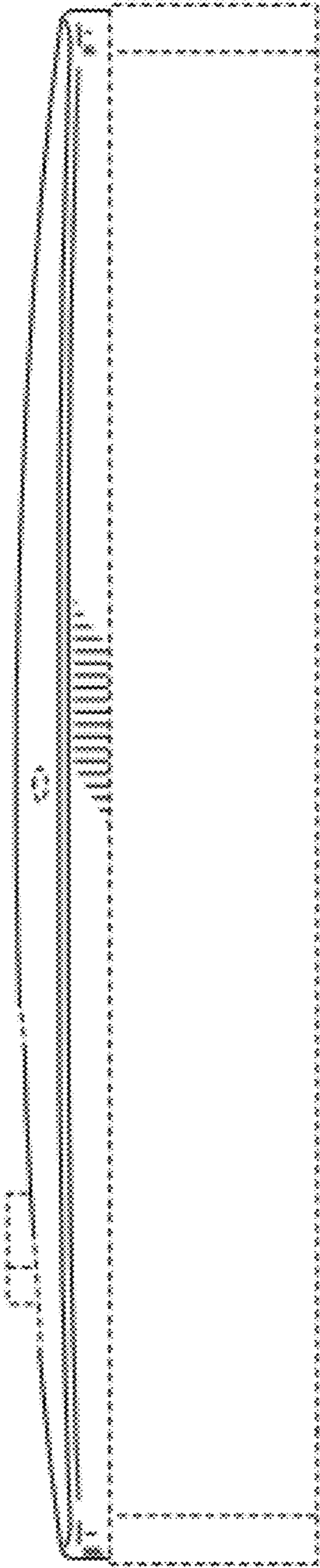

FIG. 6

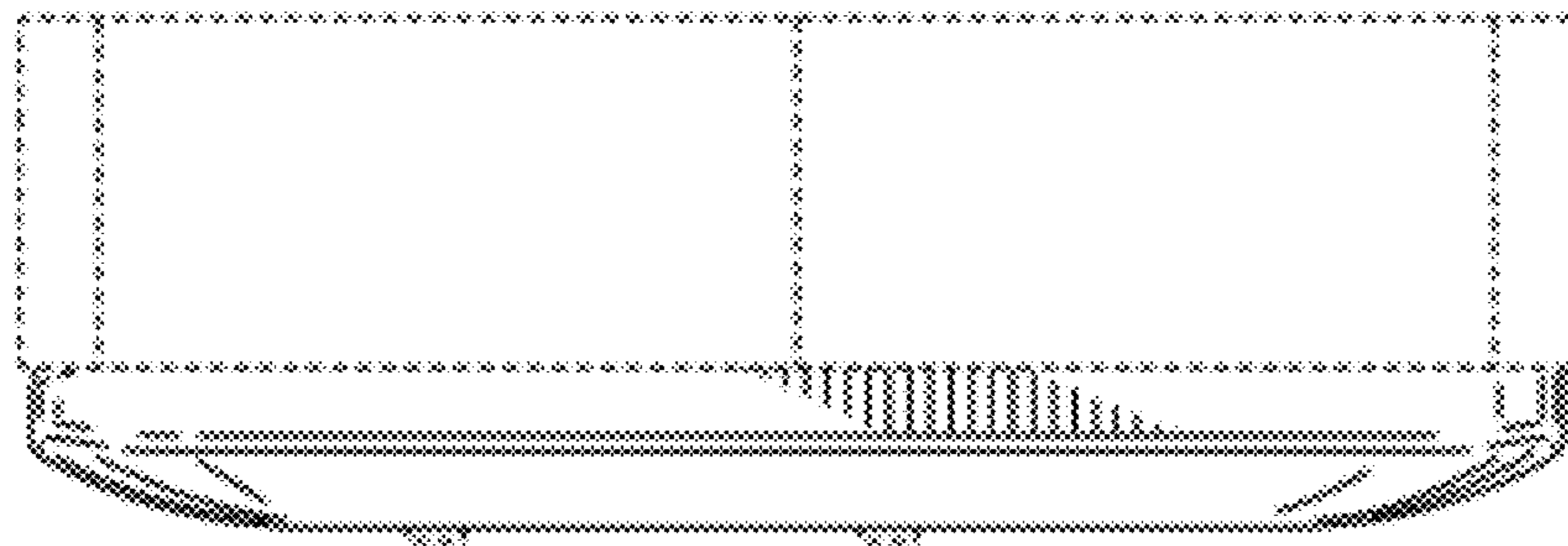

FIG. 7

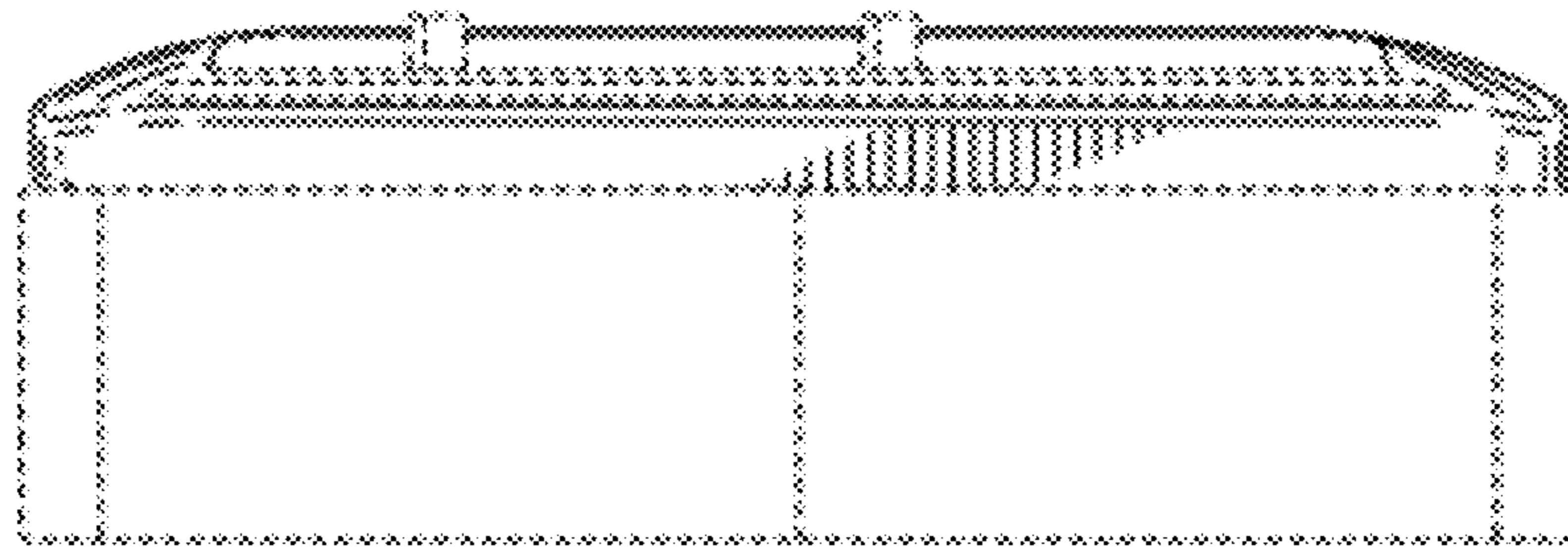

FIG. 8