



US00D655944S

(12) **United States Design Patent**
Malinski

(10) **Patent No.:** **US D655,944 S**
(45) **Date of Patent:** **** Mar. 20, 2012**

(54) **WINE BARREL HOLDER**

(75) Inventor: **Jon M. Malinski**, Paradise Valley, AZ
(US)

(73) Assignee: **Vinocopia, Inc.**, Richfield, MN (US)

(**) Term: **14 Years**

(21) Appl. No.: **29/393,878**

(22) Filed: **Jun. 10, 2011**

(51) **LOC (9) Cl.** **06-04**

(52) **U.S. Cl.** **D6/450**

(58) **Field of Classification Search** D6/450,
D6/455; D7/702; D11/157, 125; 211/13.1,
211/85.2; 428/18-19

See application file for complete search history.

(56) **References Cited**

U.S. PATENT DOCUMENTS

D276,962	S	*	1/1985	Moore	D6/450
5,962,088	A	*	10/1999	Tanaka et al.	428/18
D460,719	S	*	7/2002	Lewis	D11/157
D507,989	S	*	8/2005	Lamb	D11/125
7,524,544	B2	*	4/2009	Truong	428/18
D610,370	S	*	2/2010	Quan	D6/455
D621,635	S	*	8/2010	Murphy	D6/450

* cited by examiner

Primary Examiner — Philip S Hyder

Assistant Examiner — Sydney Buffalow

(74) *Attorney, Agent, or Firm* — DuFault Law Firm, P.C.;
Dustin R. DuFault

(57) **CLAIM**

I claim the ornamental design for a wine barrel holder, substantially as shown and described.

DESCRIPTION

FIG. 1 is an perspective view of a wine barrel holder in accordance with the present design.

FIG. 2 is a frontal view of the wine barrel holder in accordance with the present design.

FIG. 3 is a back view of the wine barrel holder in accordance with the present design.

FIG. 4 is a right-side view of the wine barrel holder in accordance with the present design.

FIG. 5 is a left-side view of the wine barrel holder in accordance with the present design.

FIG. 6 is a top view of the wine barrel holder in accordance with the present design; and,

FIG. 7 is a bottom view of the wine barrel holder in accordance with the present design.

1 Claim, 7 Drawing Sheets

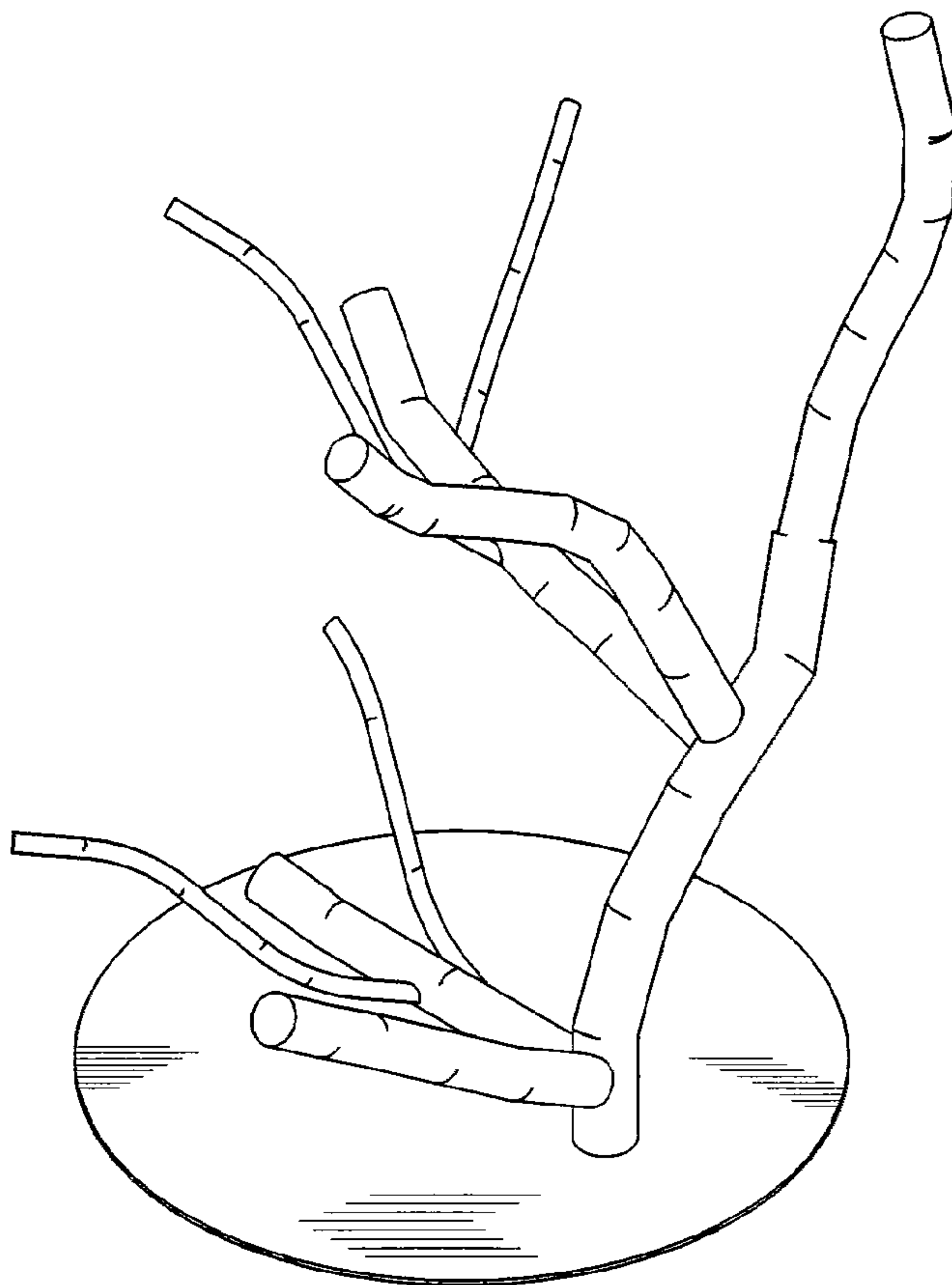

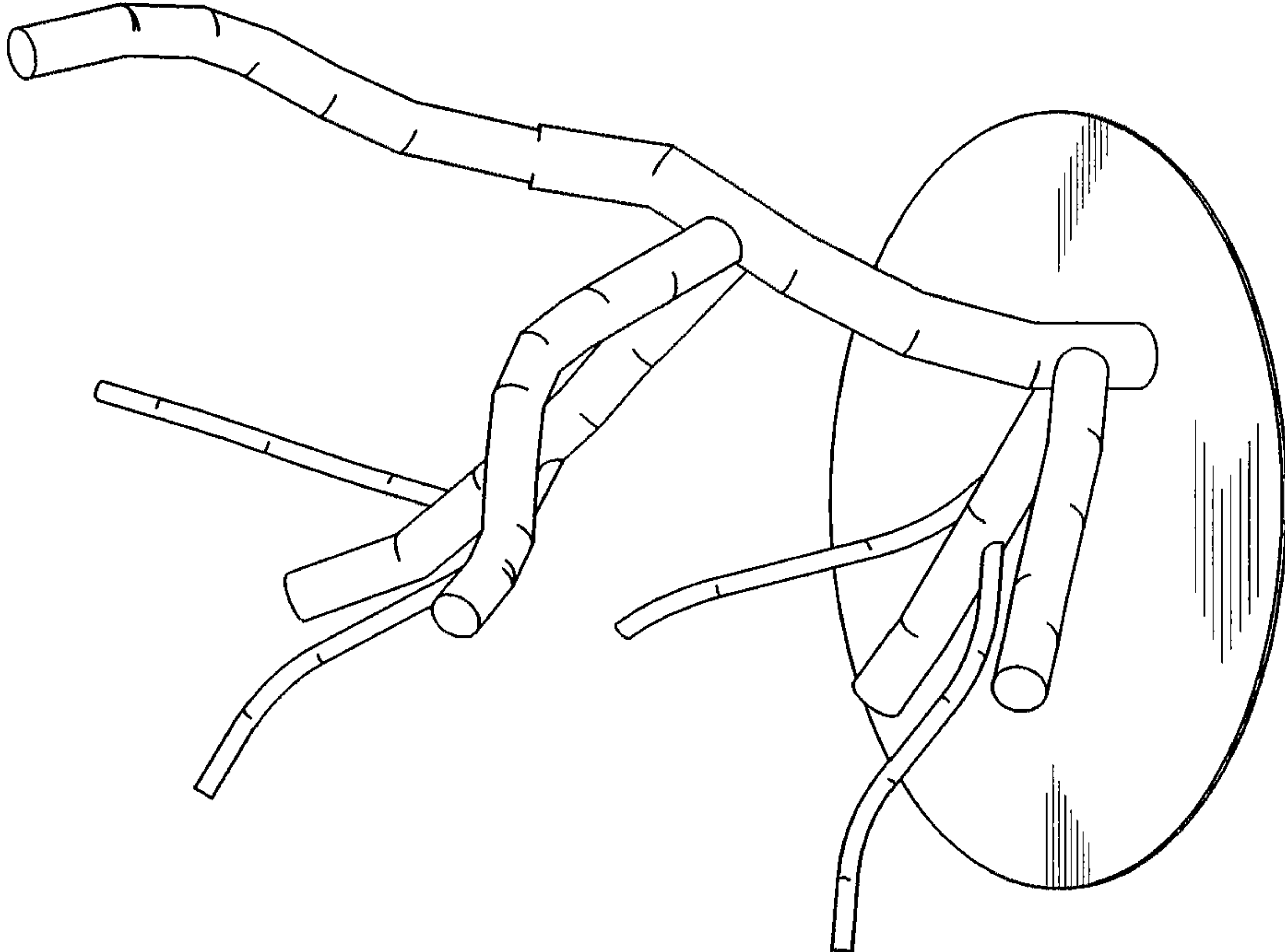

Figure 1

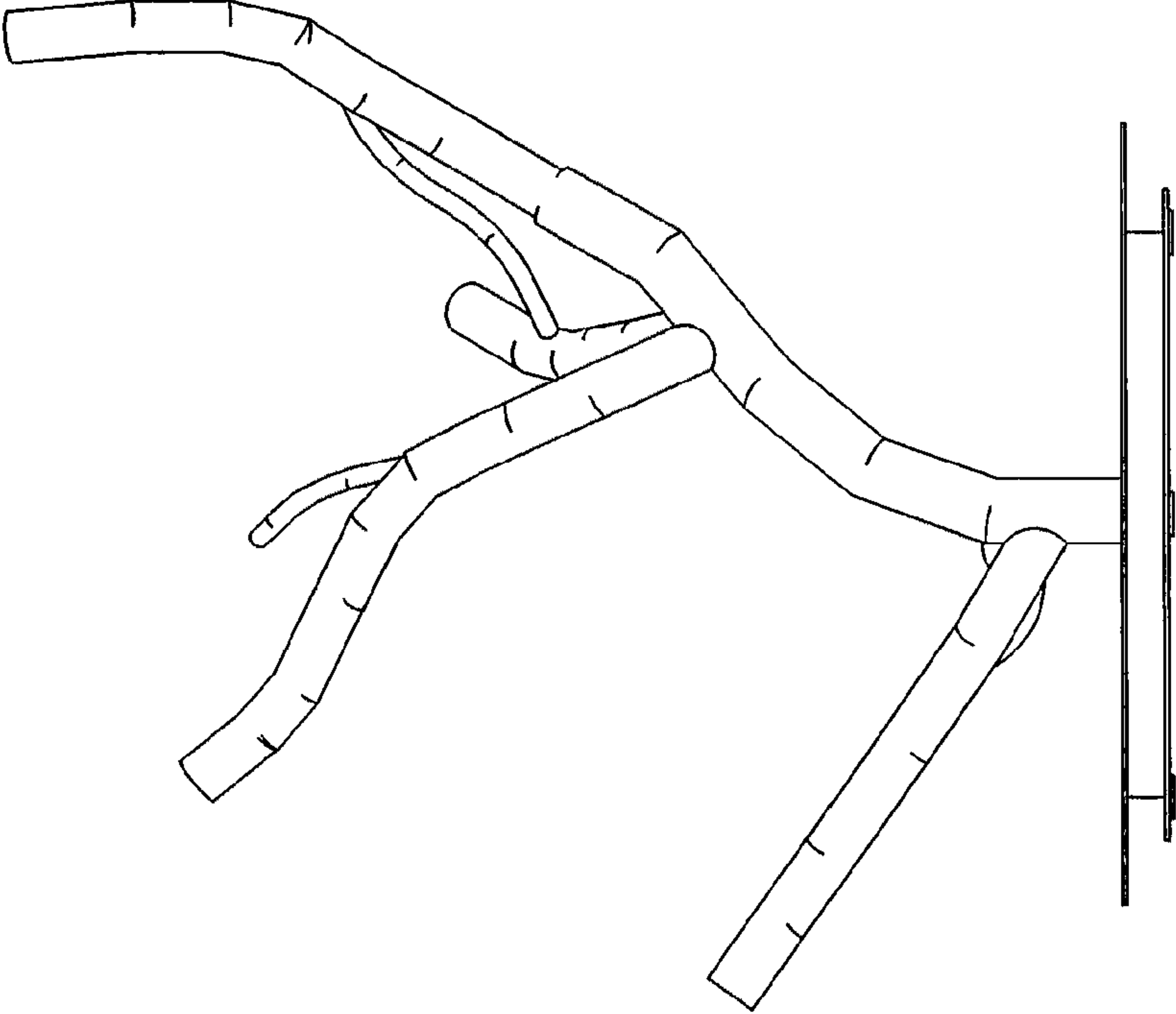

Figure 2

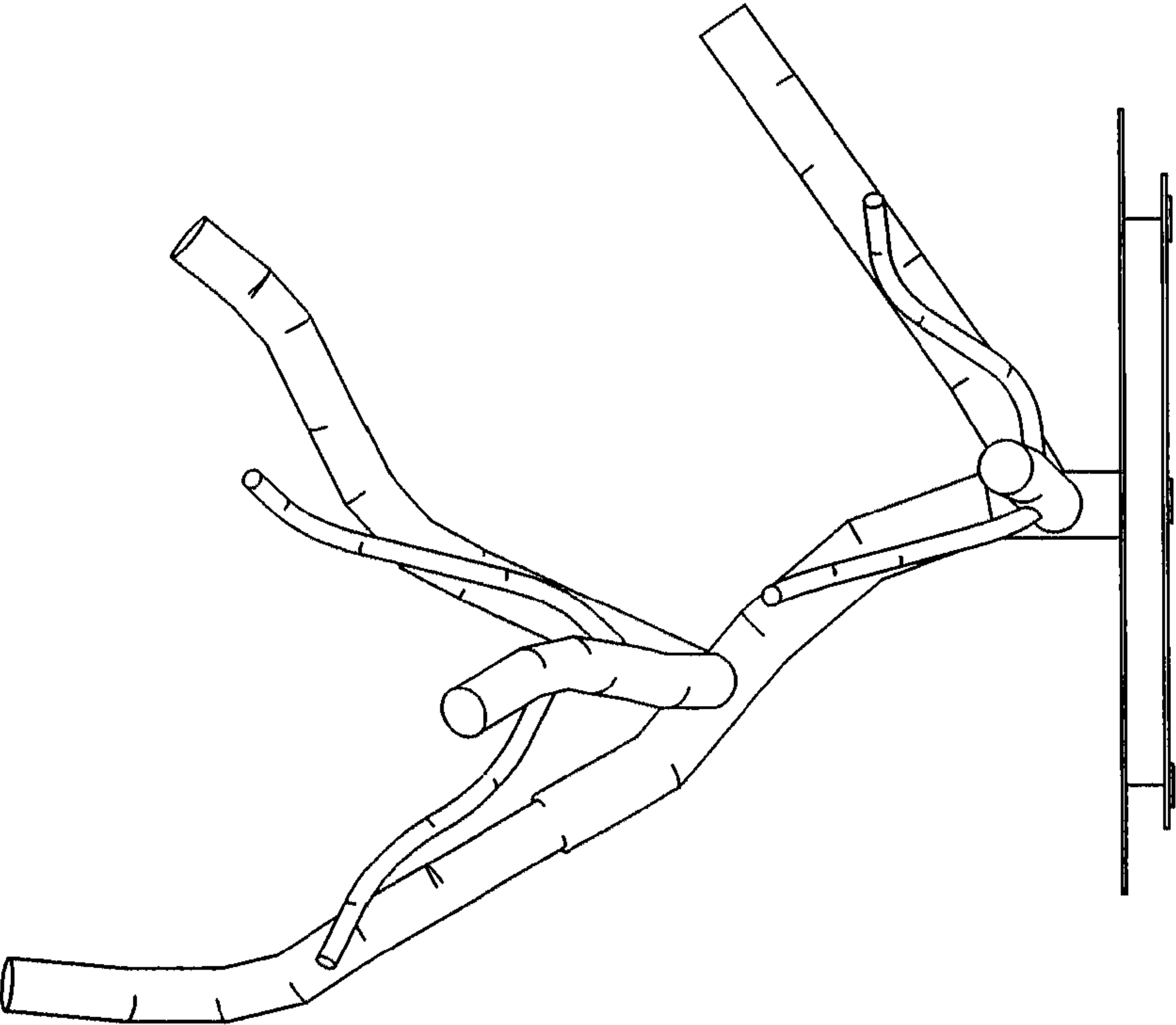

Figure 3

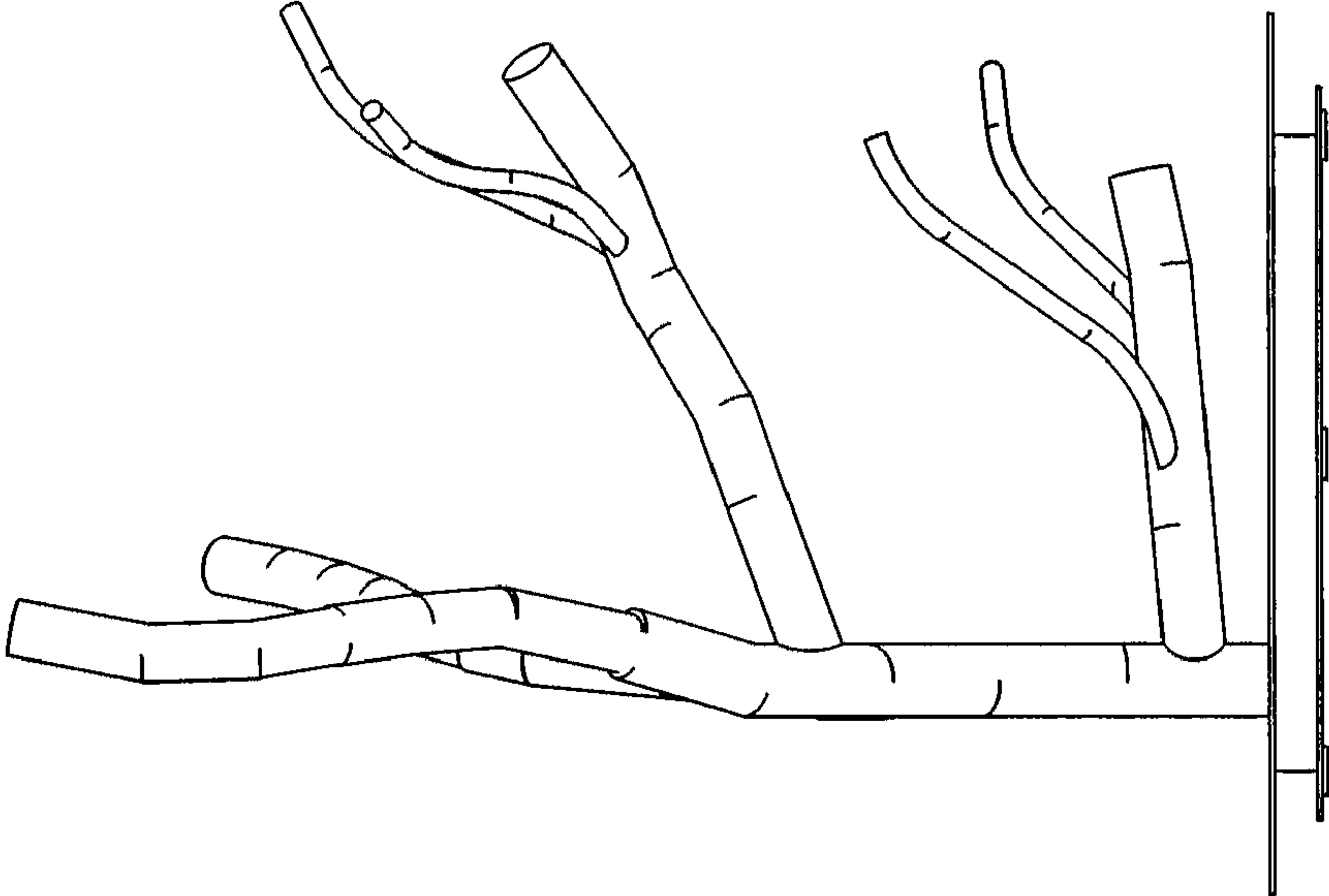

Figure 4

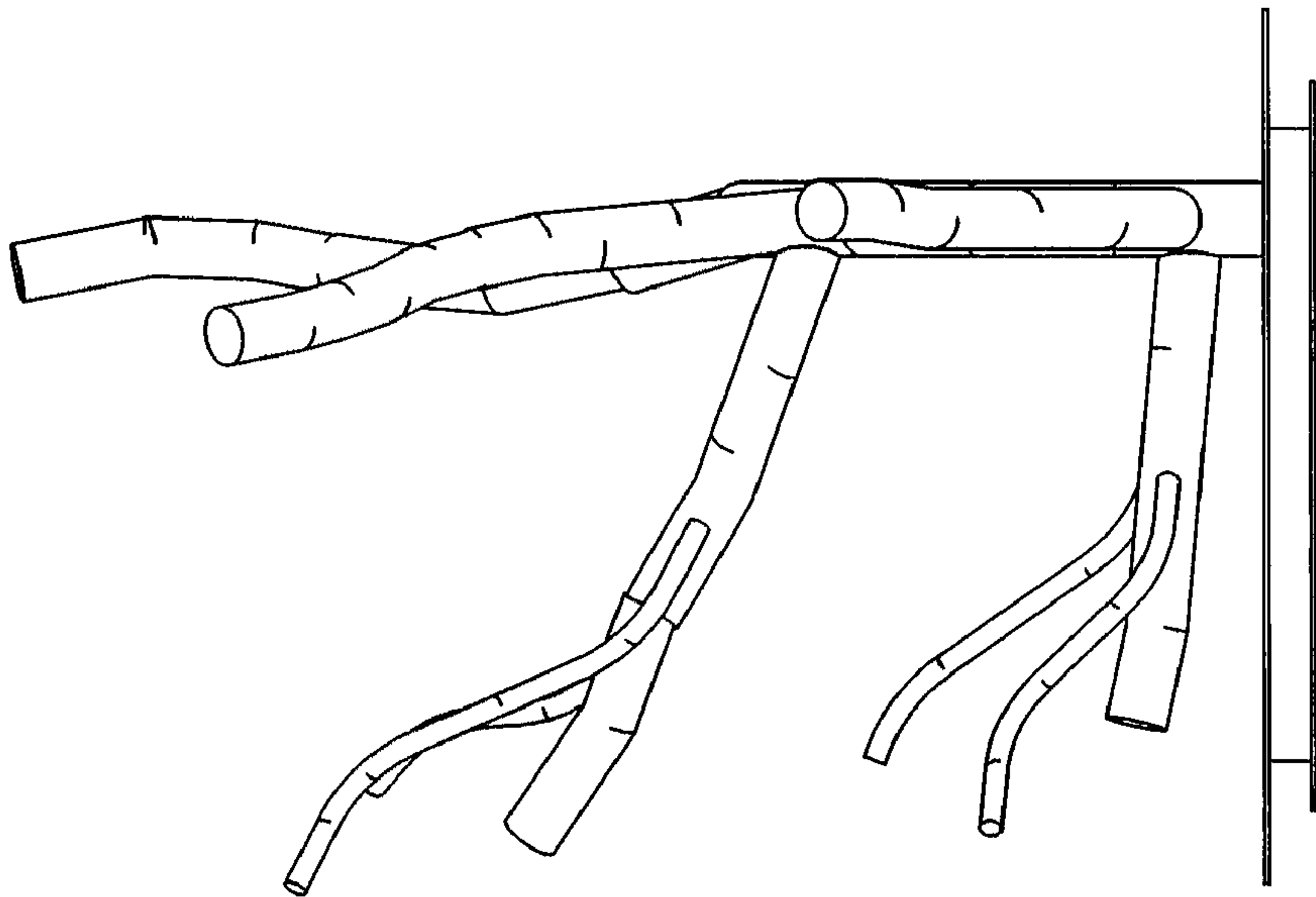

Figure 5

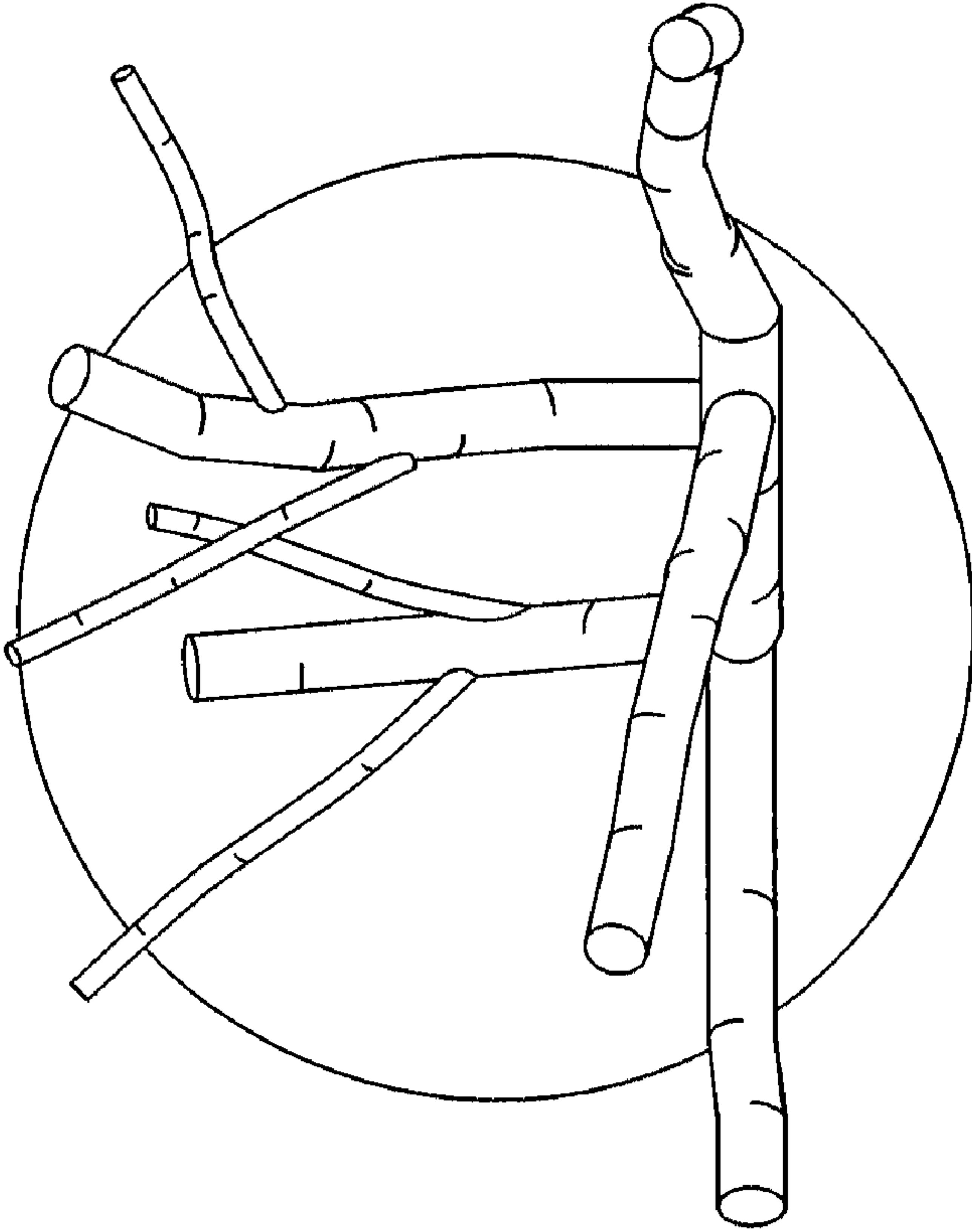

Figure 6

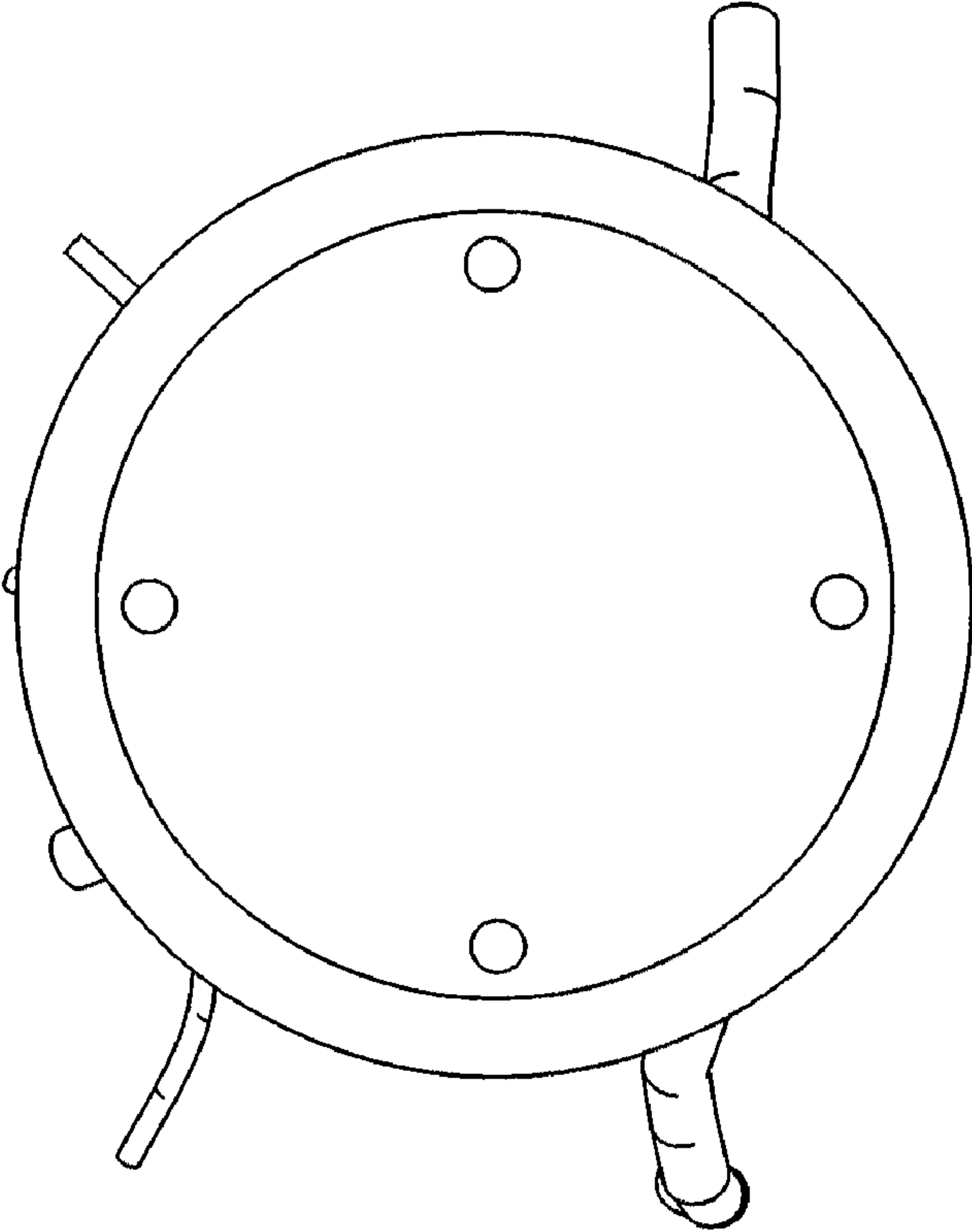

Figure 7