



US00D655866S

(12) **United States Design Patent**
Villarreal et al.

(10) **Patent No.:** **US D655,866 S**

(45) **Date of Patent:** **** *Mar. 13, 2012**

(54) **COSMETIC COMPACT**

(75) Inventors: **Armando Villarreal**, Santa Monica, CA (US); **Adrian C. Apodaca**, Santa Monica, CA (US); **Jenny Ling Chen Hsu**, Los Angeles, CA (US); **David Eberlein**, Santa Monica, CA (US); **Megan Rene Langdon**, Los Angeles, CA (US)

(73) Assignee: **HCT Asia Ltd.**, Central (HK)

(*) Notice: This patent is subject to a terminal disclaimer.

(**) Term: **14 Years**

(21) Appl. No.: **29/383,978**

(22) Filed: **Jan. 25, 2011**

(51) **LOC (9) Cl.** **28-03**

(52) **U.S. Cl.** **D28/83**

(58) **Field of Classification Search** D28/76–84;
132/286–288, 291, 293–307, 313–318; 206/823,
206/581

See application file for complete search history.

(56) **References Cited**

U.S. PATENT DOCUMENTS

| | | | | | | |
|-----------|----|---|---------|------------------|-------|---------|
| D422,120 | S | * | 3/2000 | Orsomando | | D28/83 |
| D434,875 | S | * | 12/2000 | Gavin | | D28/83 |
| D457,986 | S | * | 5/2002 | Rodriguez et al. | | D28/78 |
| D503,245 | S | * | 3/2005 | Vanoncini | | D28/78 |
| D507,078 | S | * | 7/2005 | Greenfield | | D28/82 |
| 7,240,402 | B2 | * | 7/2007 | Suzuki et al. | | 132/293 |
| D554,804 | S | * | 11/2007 | Bernard | | D28/83 |
| D576,354 | S | * | 9/2008 | Dominski et al. | | D28/83 |
| D576,770 | S | * | 9/2008 | Mascotte et al. | | D28/83 |
| D592,956 | S | * | 5/2009 | Thiellier | | D9/504 |

| | | | | | | |
|--------------|----|---|---------|----------|-------|---------|
| D595,900 | S | * | 7/2009 | Yamamoto | | D28/83 |
| 7,828,000 | B2 | * | 11/2010 | Lee | | 132/287 |
| 2009/0293902 | A1 | * | 12/2009 | Ramos | | 132/287 |
| 2010/0031971 | A1 | * | 2/2010 | Ha | | 132/293 |
| 2010/0307530 | A1 | * | 12/2010 | Bennett | | 132/307 |

OTHER PUBLICATIONS

Office action for U.S. Appl. No. 29/383,974, mailed on Aug. 8, 2011, Villarreal et al., "Cosmetic Compact," 6 pages.

* cited by examiner

Primary Examiner — Jennifer Rivard

(74) *Attorney, Agent, or Firm* — Lee & Hayes, PLLC

(57) **CLAIM**

The ornamental design for a cosmetic compact, as shown and described.

DESCRIPTION

FIG. 1 is a perspective view of a cosmetic compact;
FIG. 2 is a front elevation view of the cosmetic compact of FIG. 1;
FIG. 3 is a back elevation view of the cosmetic compact of FIG. 1;
FIG. 4 is a left-side elevation view of the cosmetic compact of FIG. 1;
FIG. 5 is a right-side elevation view of the cosmetic compact of FIG. 1;
FIG. 6 is a top plan view of the cosmetic compact of FIG. 1;
and,
FIG. 7 is a bottom plan view of the cosmetic compact of FIG. 1.

The broken lines shown in the drawings illustrate portions of the hinge and form no part of the claimed design.

The internal features of the cosmetic compact that would be visible through the transparent window in the top are not shown and do not form part of the claimed design.

1 Claim, 7 Drawing Sheets

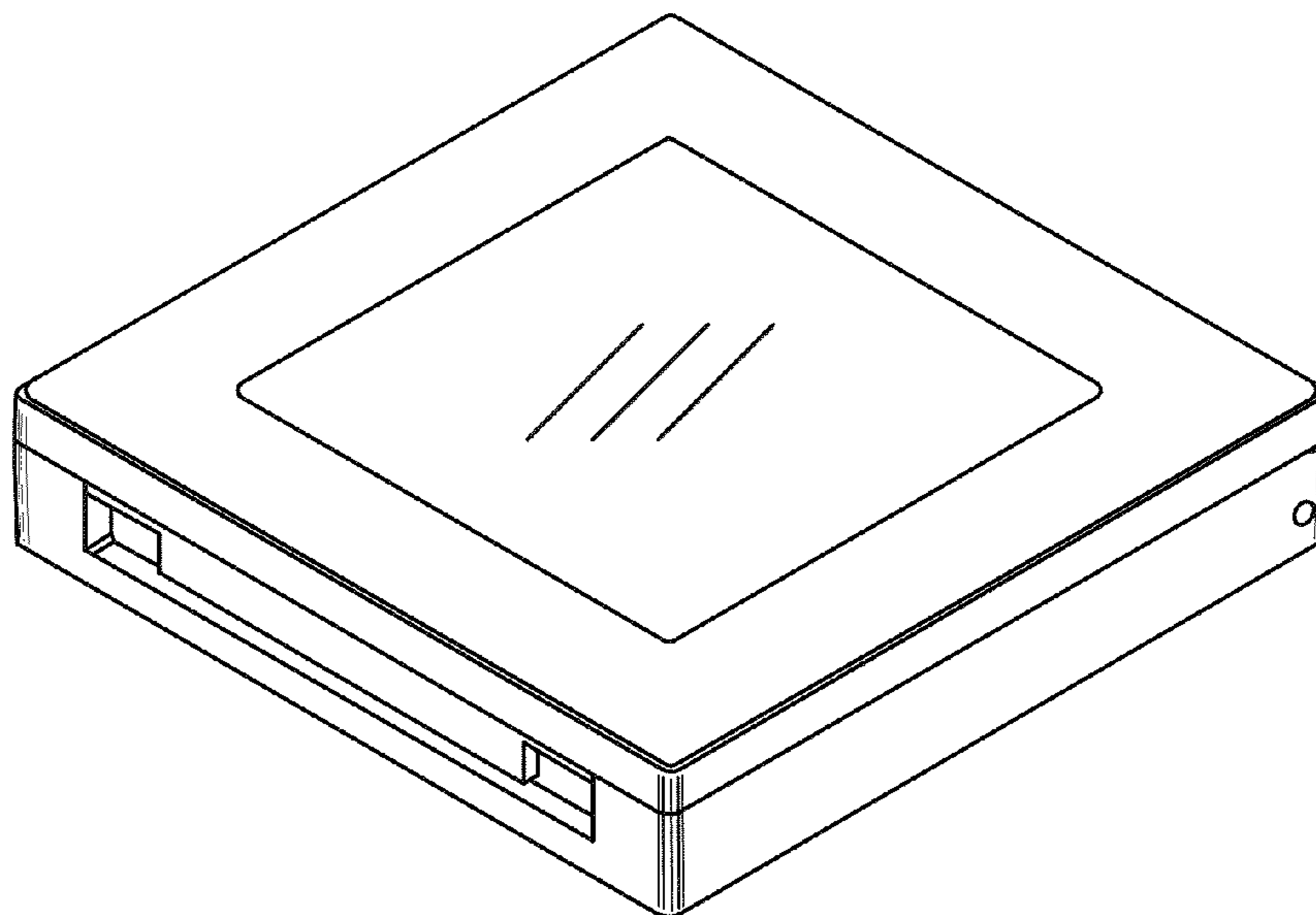

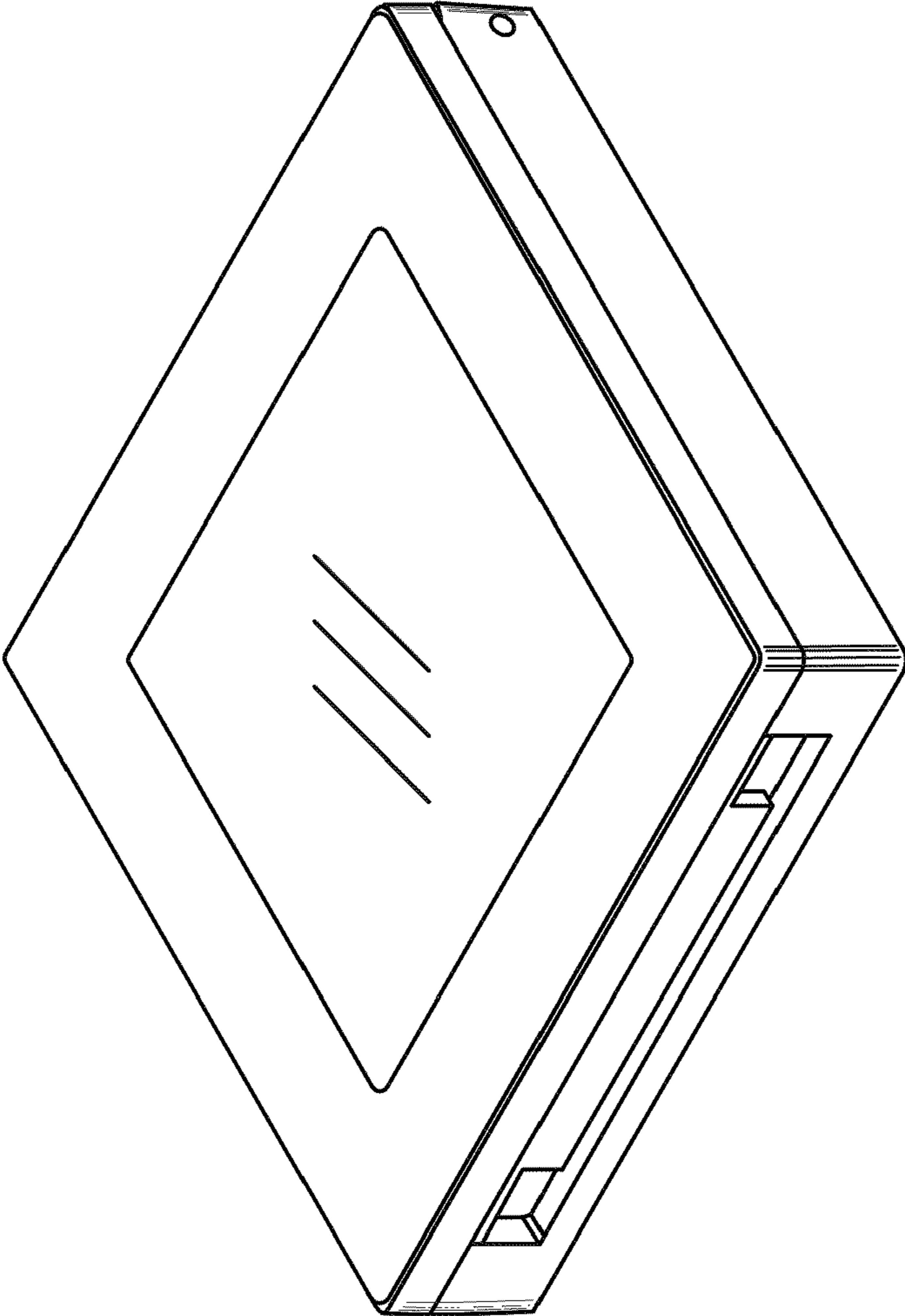

FIG. 1

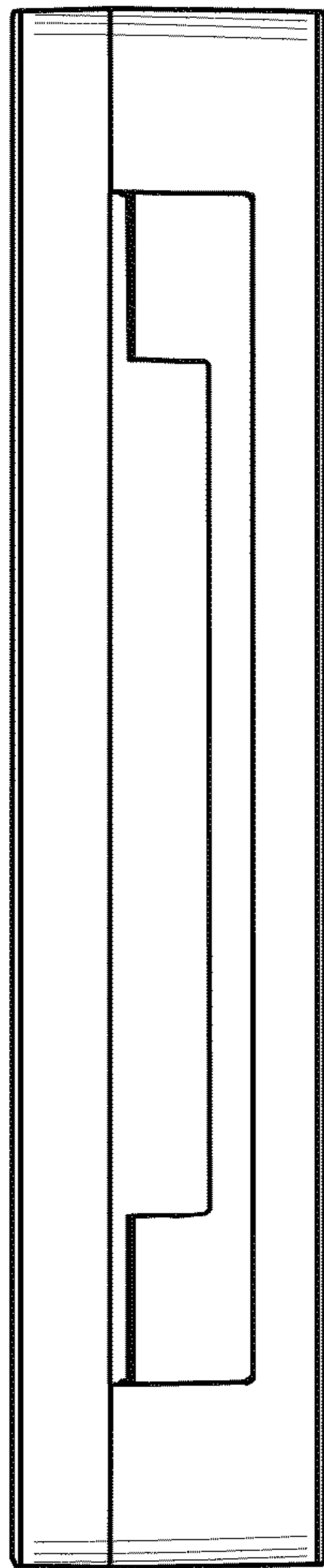

FIG. 2

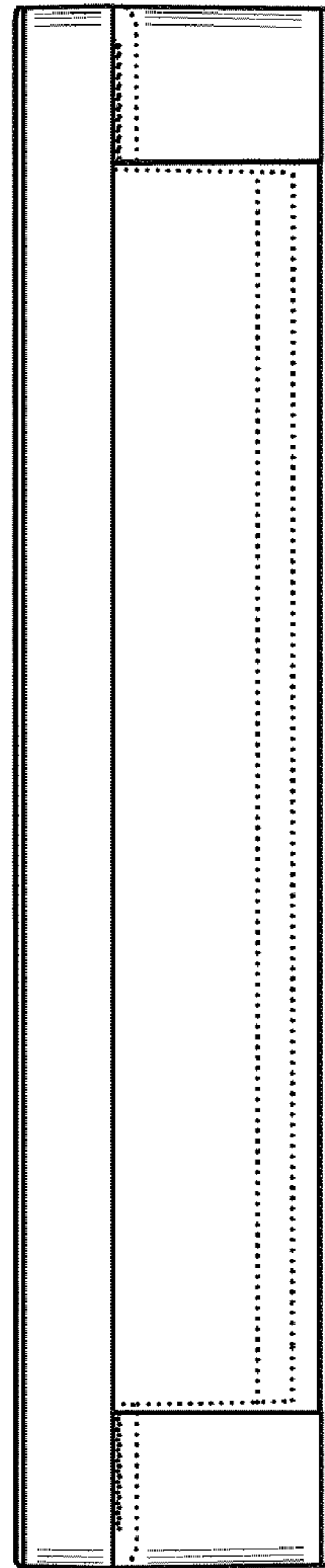

FIG. 3

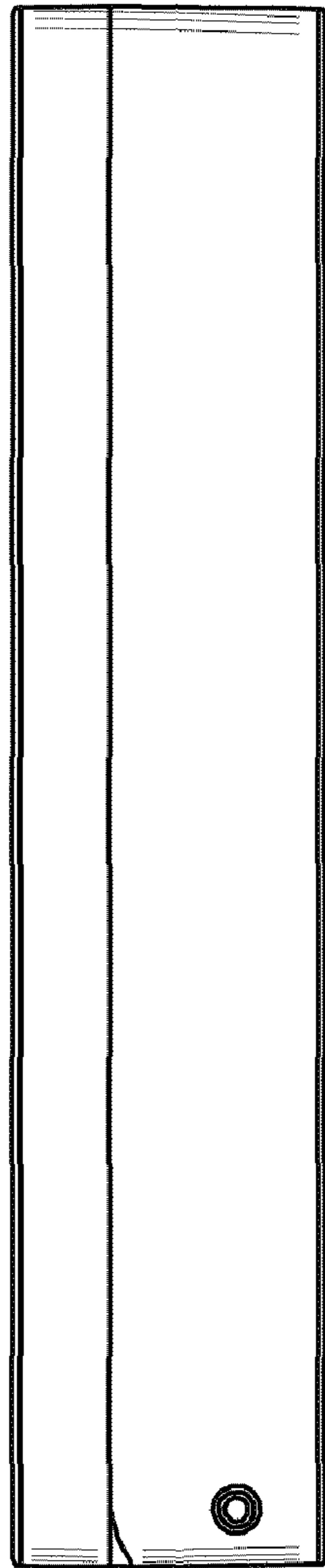

FIG. 4

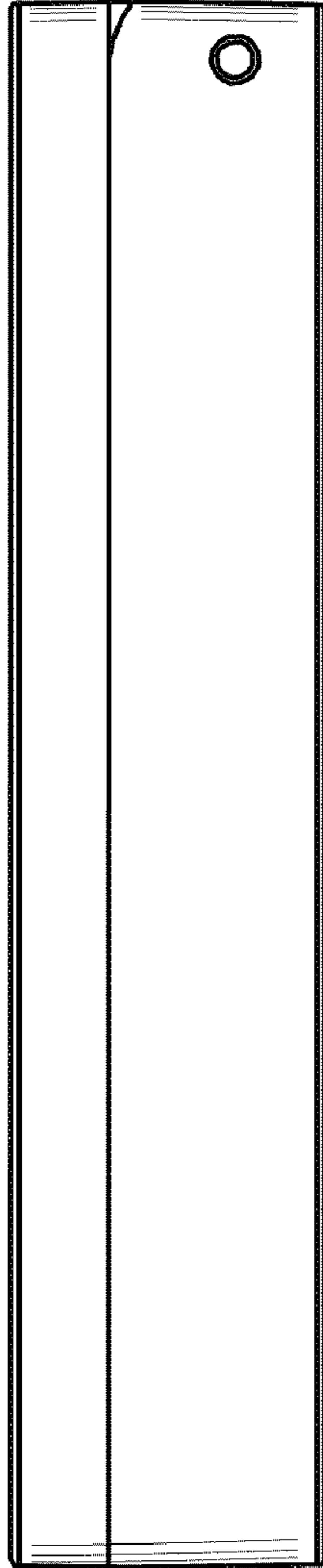

FIG. 5

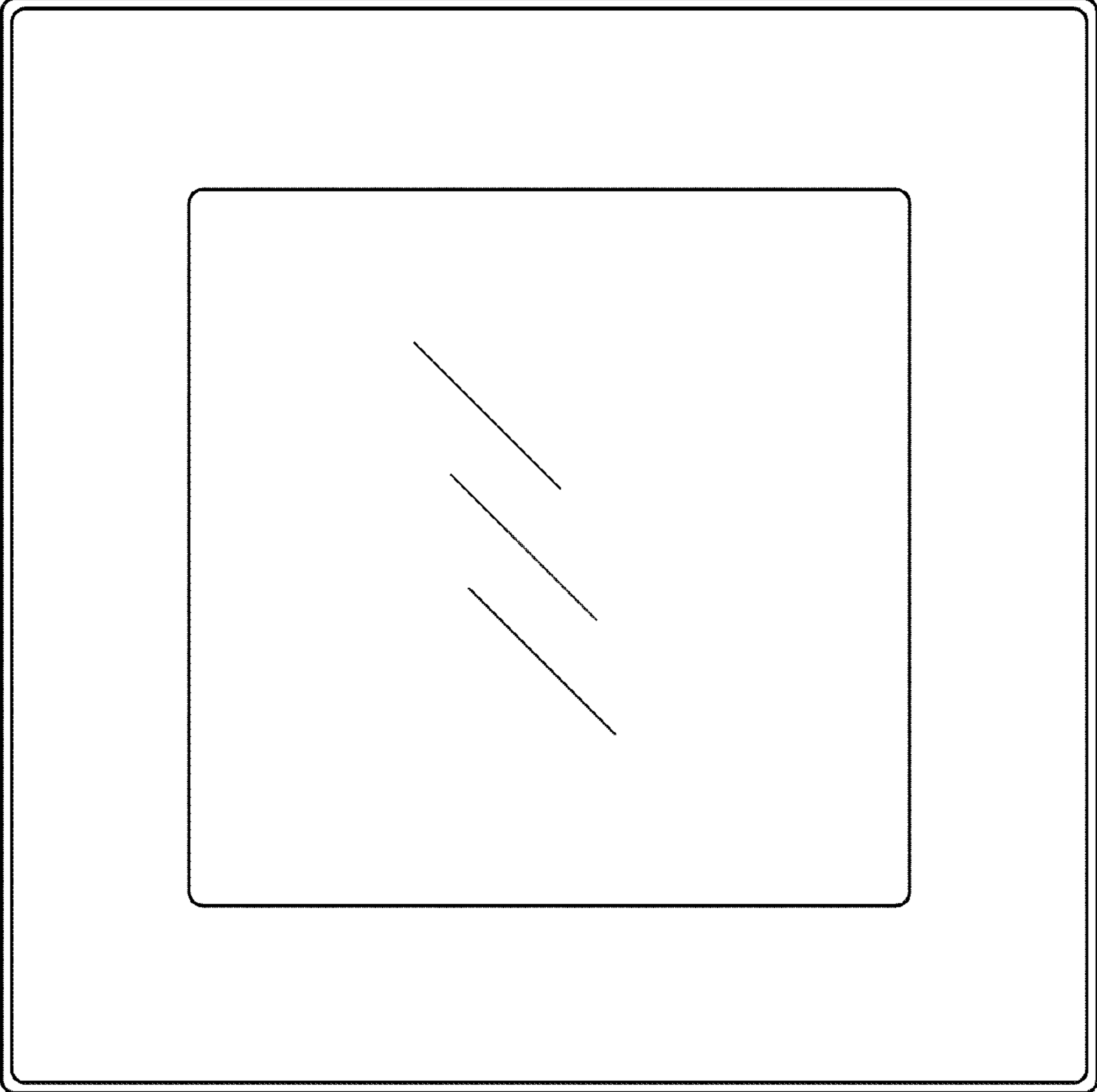

FIG. 6

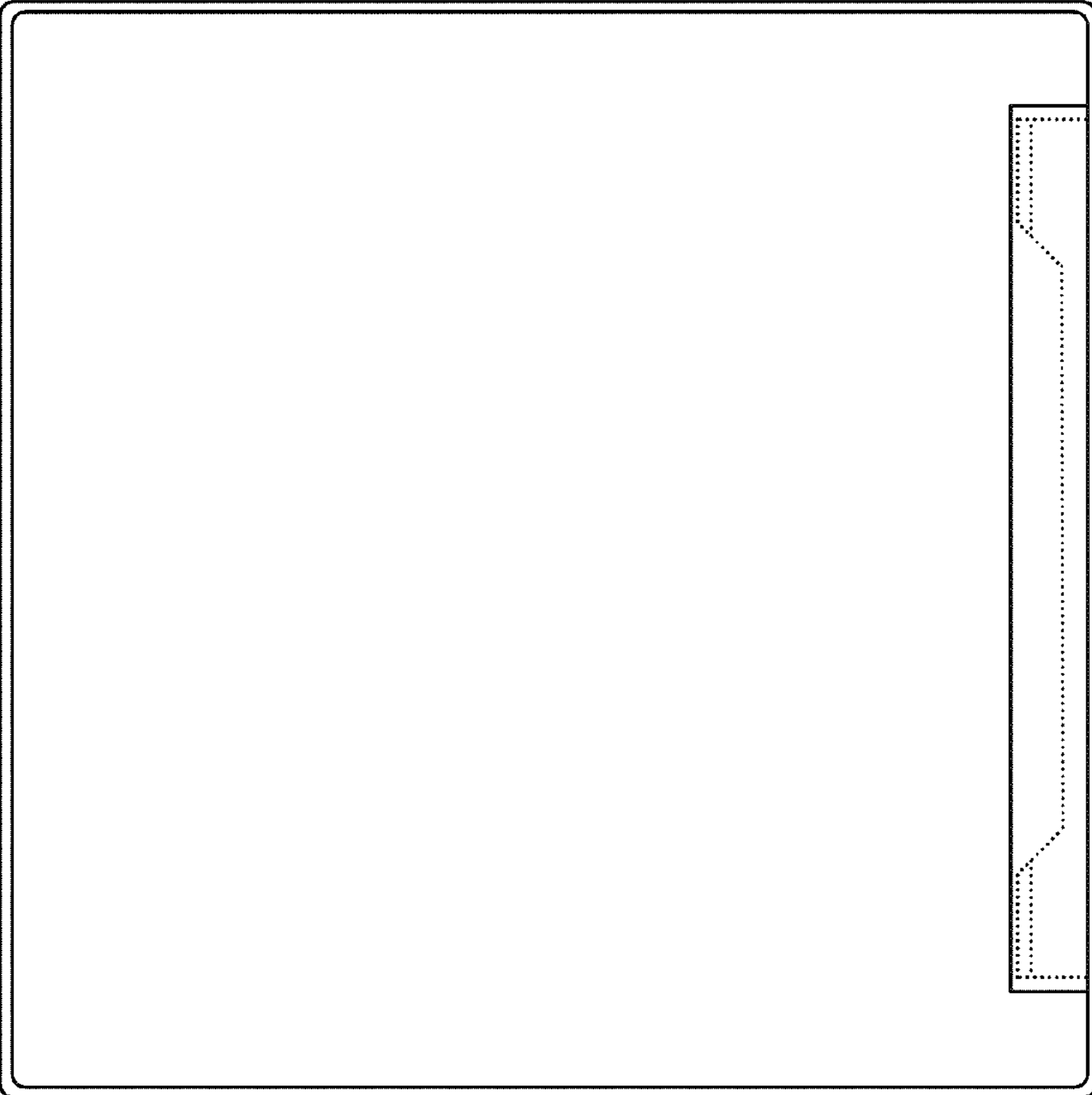

FIG. 7