

US00D655791S

(12) **United States Design Patent**  
**Kwok**

(10) **Patent No.:** **US D655,791 S**

(45) **Date of Patent:** **\*\* Mar. 13, 2012**

(54) **FAUCET BODY**

(75) Inventor: **Celine Kwok**, Carmel, IN (US)

(73) Assignee: **Masco Corporation of Indiana**,  
Indianapolis, IN (US)

(\*\*) Term: **14 Years**

(21) Appl. No.: **29/390,002**

(22) Filed: **Apr. 19, 2011**

(51) **LOC (9) Cl.** ..... **02-01**

(52) **U.S. Cl.** ..... **D23/257**

(58) **Field of Classification Search** ..... D23/255,  
D23/257, 238, 241-243; 4/676-678; 137/801  
See application file for complete search history.

(56) **References Cited**

U.S. PATENT DOCUMENTS

D424,663 S *	5/2000	Mark et al. ....	D23/238
D467,995 S *	12/2002	Lord .....	D23/238
D520,602 S *	5/2006	Koury et al. ....	D23/241

\* cited by examiner

*Primary Examiner* — Robert Delehanty

(74) *Attorney, Agent, or Firm* — Edgar A. Zarins; Nirav D. Parikh; Lora J. Graentzdoerffer

(57) **CLAIM**

The ornamental design for a faucet body, as shown and described.

**DESCRIPTION**

FIG. 1 is a perspective view of a faucet body showing my new design;

FIG. 2 is a front elevational view thereof;

FIG. 3 is a rear view thereof;

FIG. 4 is a left side view thereof, the opposite side being a mirror image of the side shown;

FIG. 5 is a top plan view thereof; and,

FIG. 6 is a bottom view thereof.

The broken line showing environment is included for the purpose of illustrating a portion of the faucet that forms no part of the claimed design.

**1 Claim, 2 Drawing Sheets**

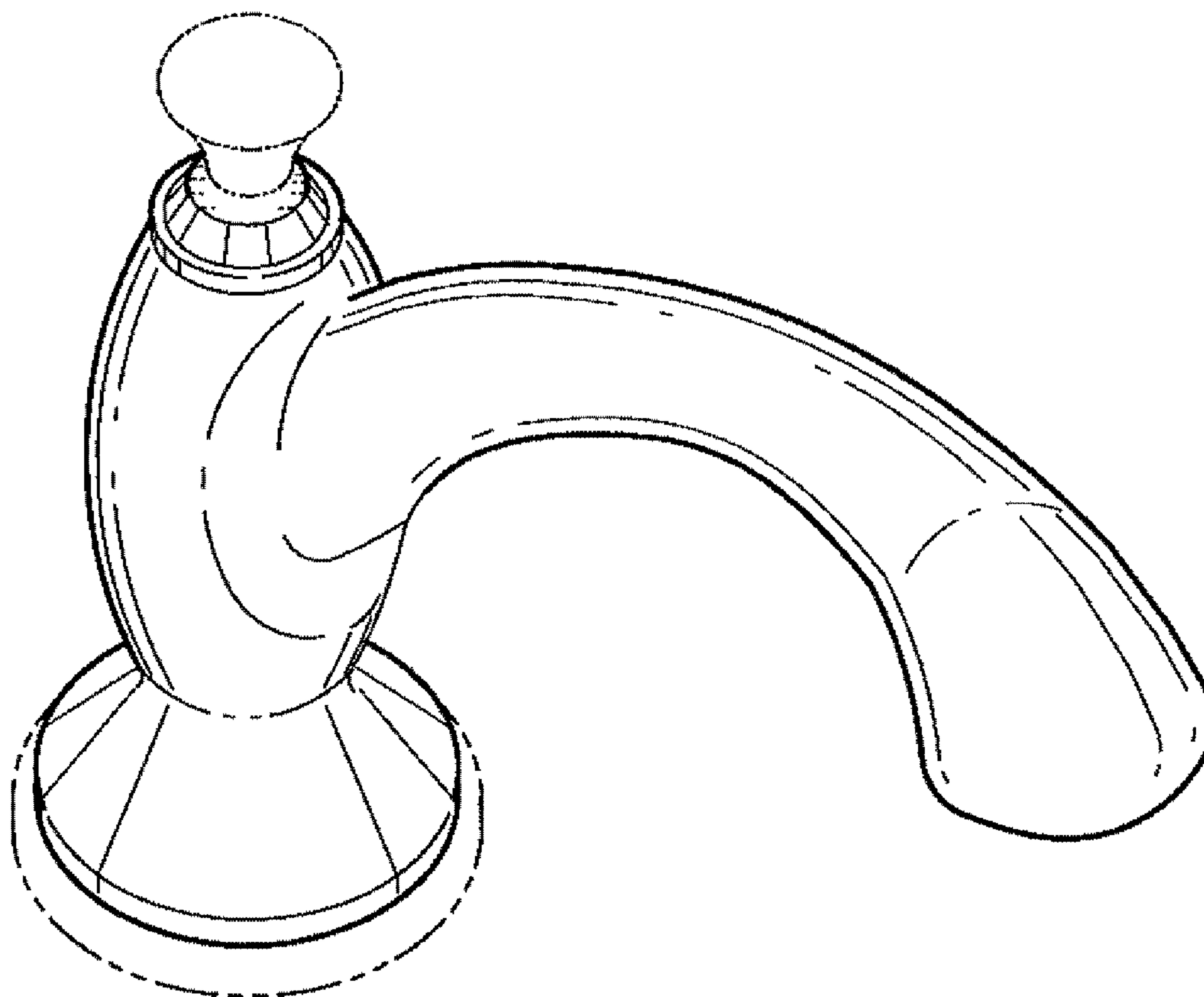

Fig-1

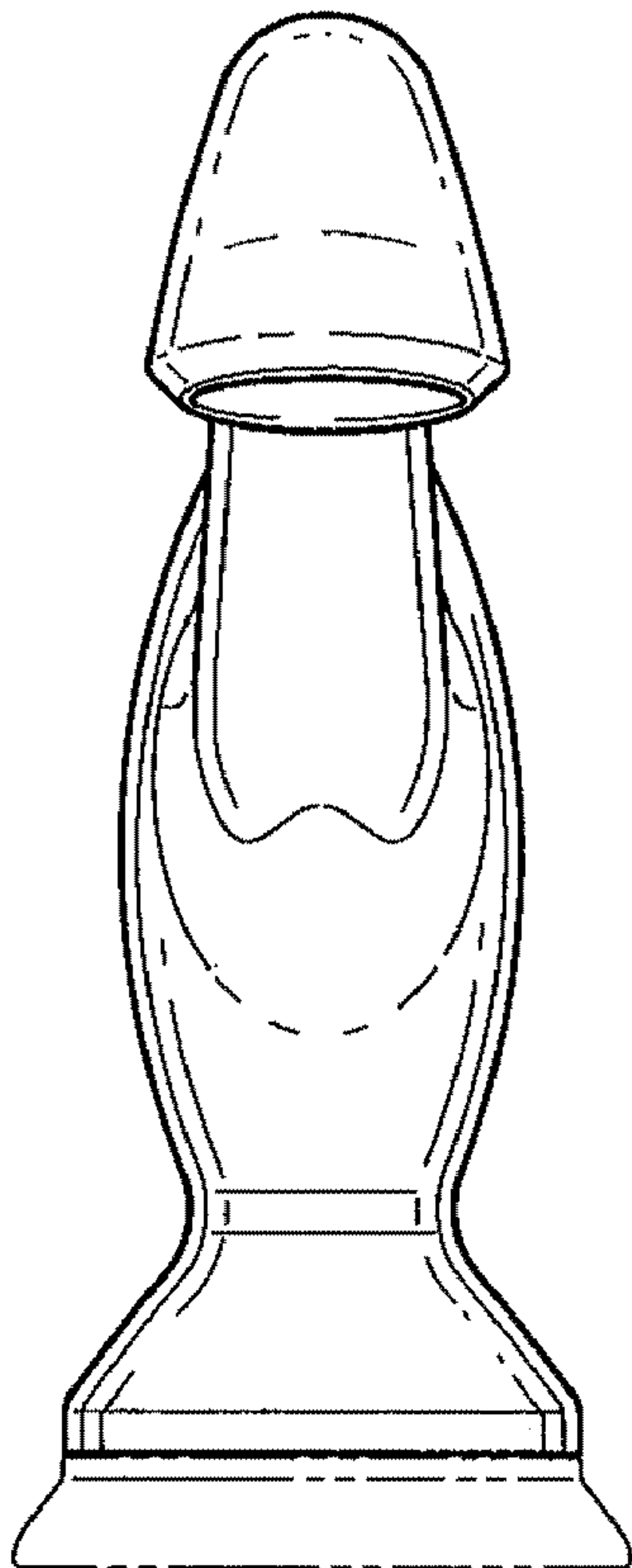
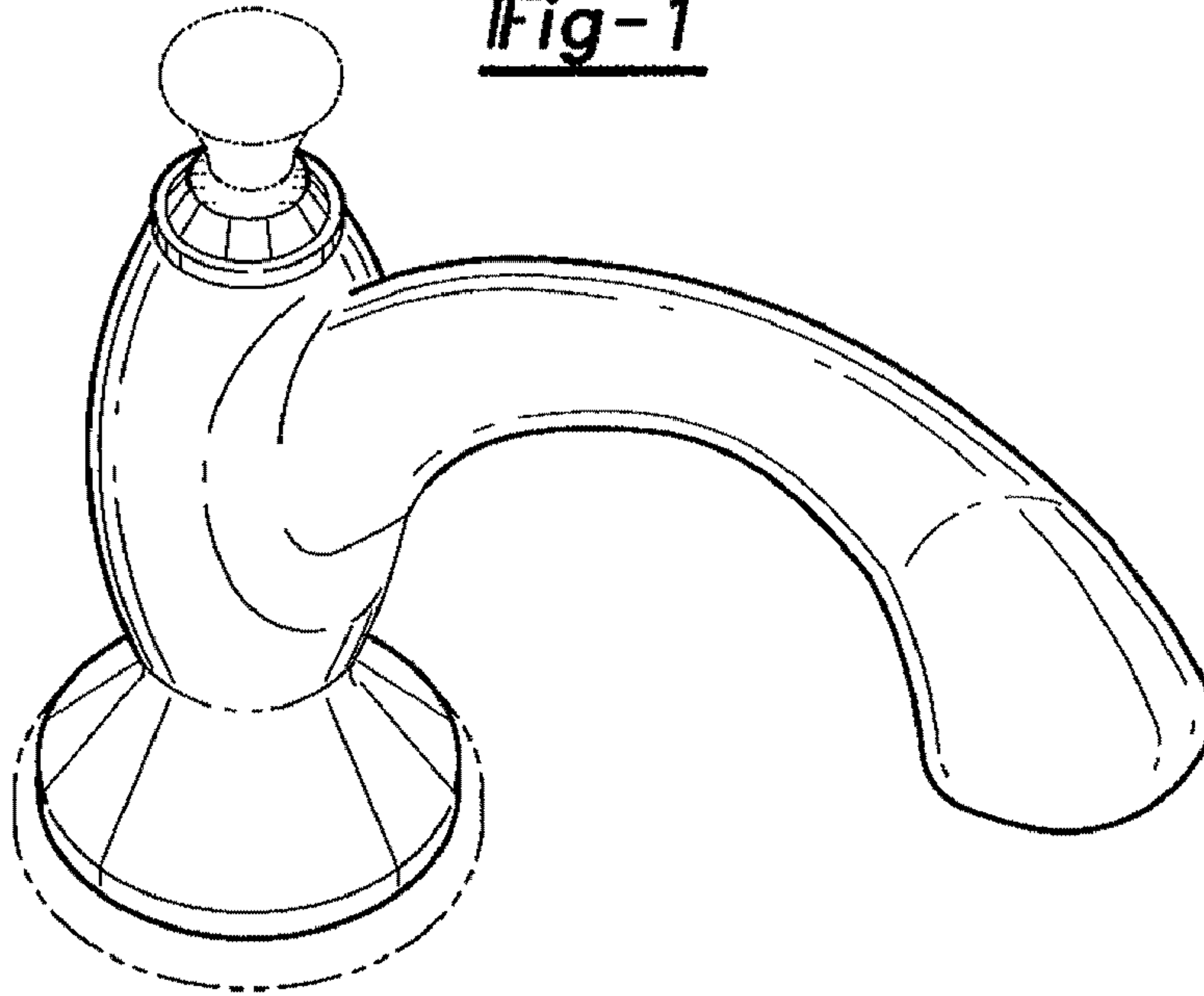

Fig-2

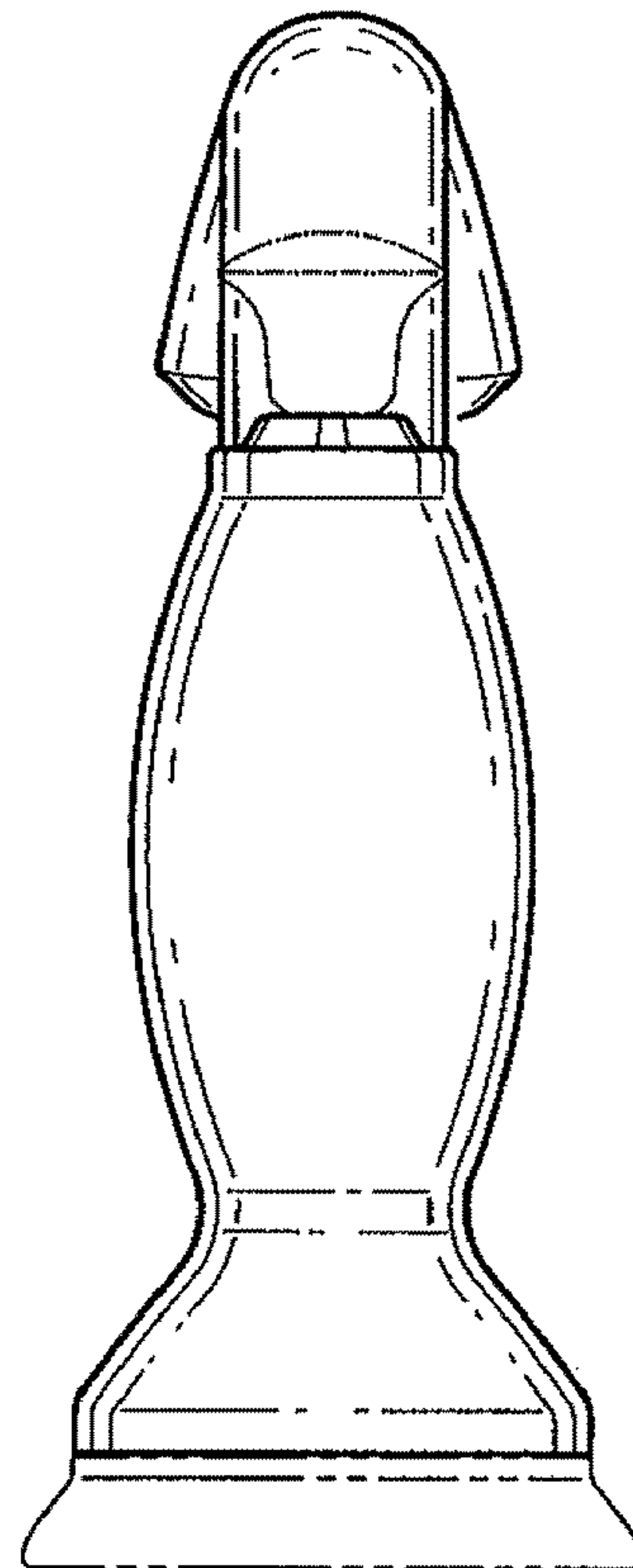

Fig-3

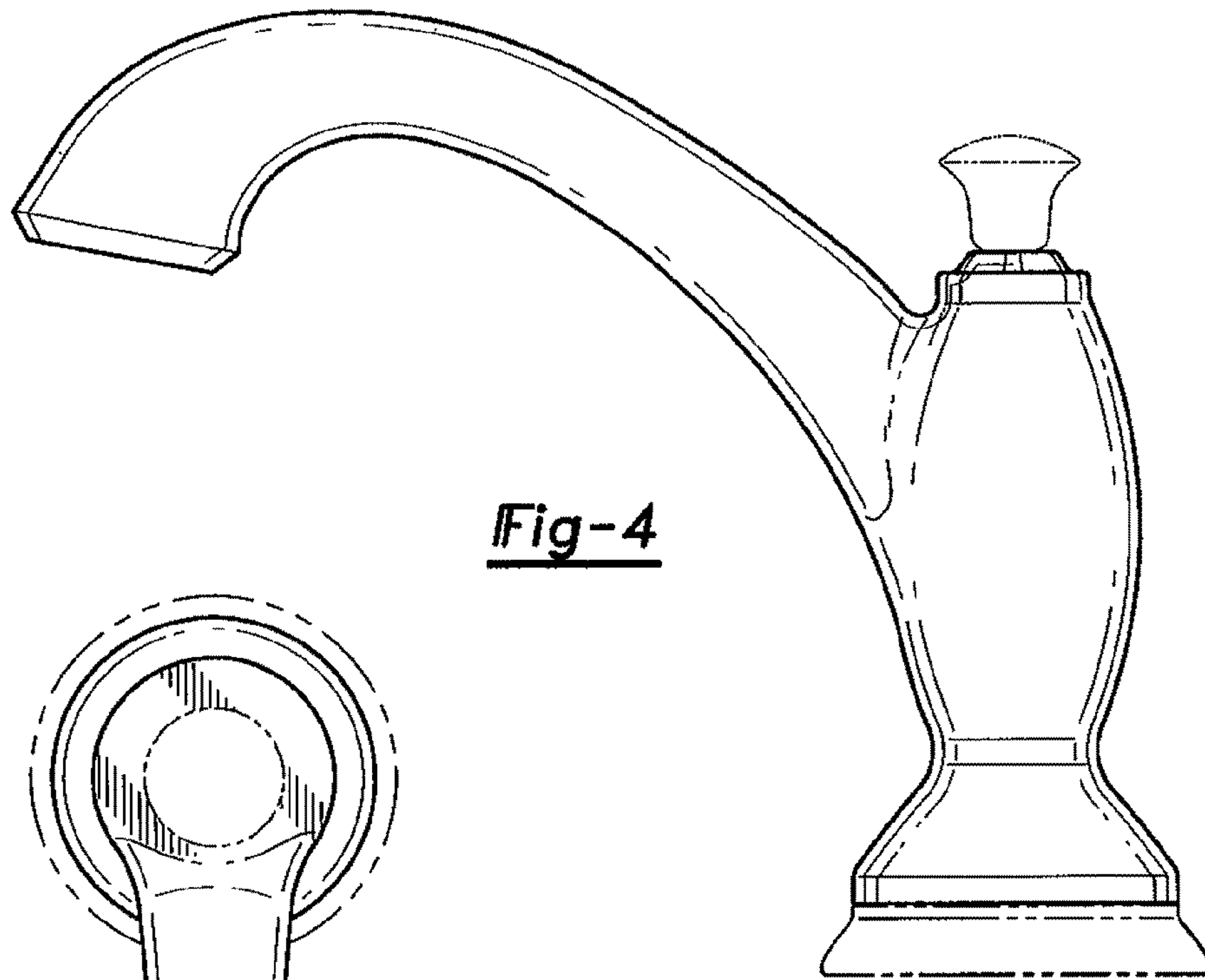

Fig-4

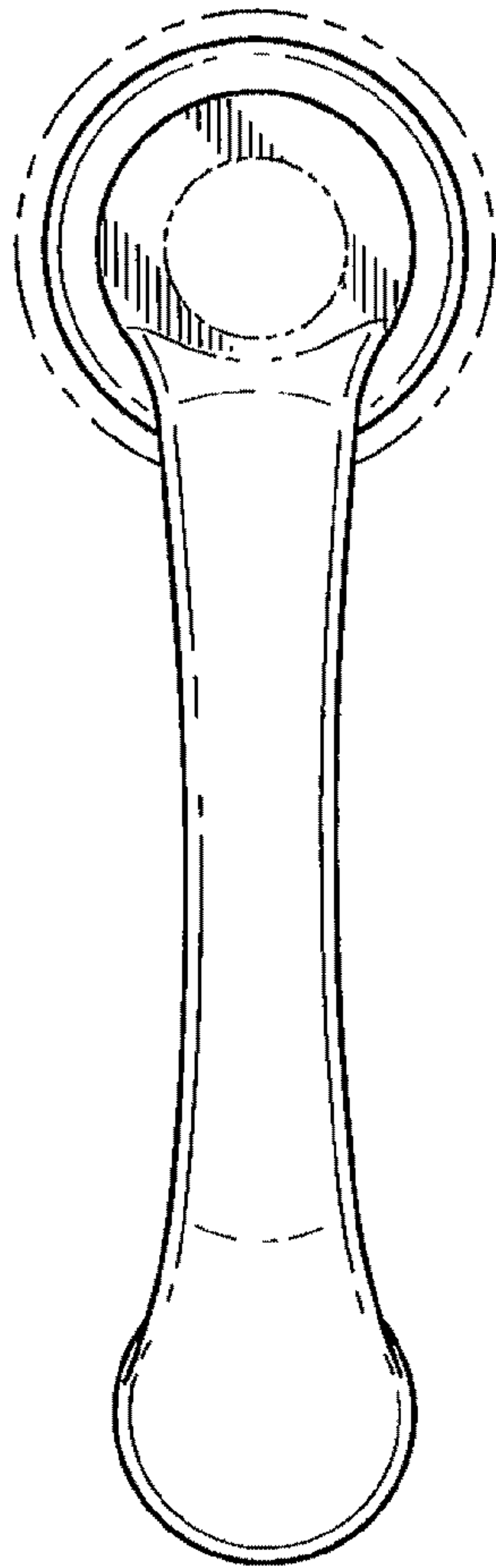

Fig-5

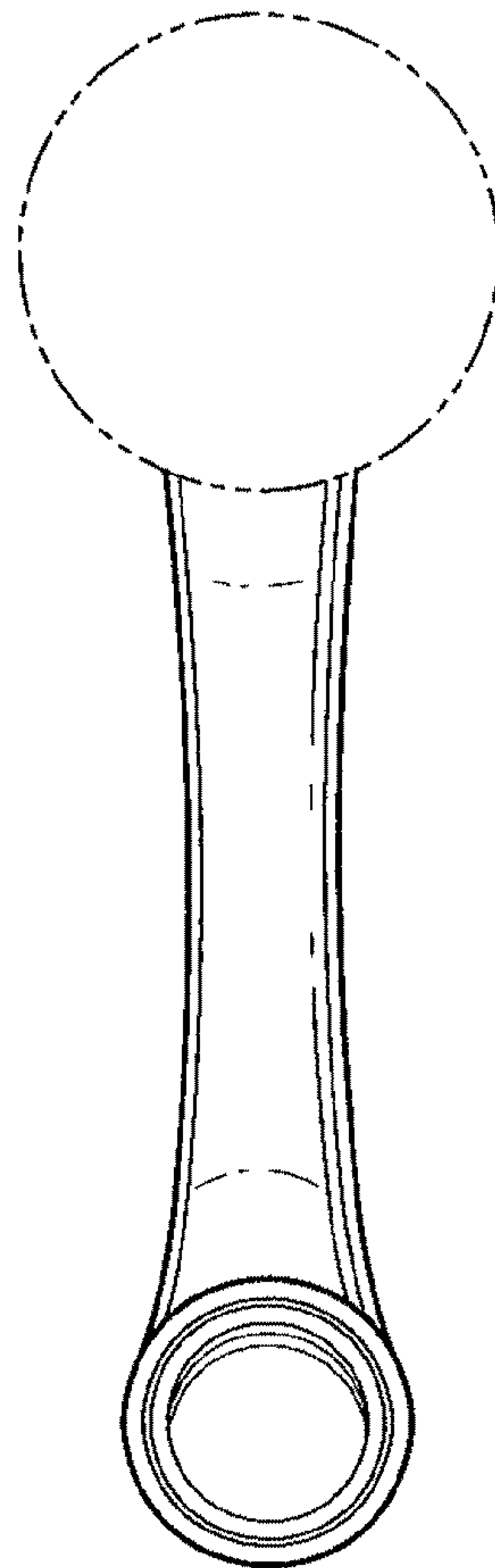

Fig-6