

US00D655775S

(12) **United States Design Patent**
Shaffer et al.

(10) **Patent No.:** **US D655,775 S**
(45) **Date of Patent:** **** Mar. 13, 2012**

(54) **CRANK HANDLE WITH CLUTCH**

(56) **References Cited**

(75) Inventors: **Michael J. Shaffer**, Mogadore, OH
(US); **Russell Beavers**, Mogadore, OH
(US); **Richard L. Bednar**, Munroe Falls,
OH (US); **Carl J. Maxfield**, Canton, OH
(US)

U.S. PATENT DOCUMENTS
D423,634 S * 4/2000 Tao et al. D22/140
6,364,229 B1 * 4/2002 Kang 242/283
D466,968 S * 12/2002 Hong D22/140
* cited by examiner

(73) Assignee: **Hunter's Manufacturing Company,**
Inc., Suffield, OH (US)

Primary Examiner — Michael Pratt
(74) *Attorney, Agent, or Firm* — Brouse McDowell; Stephen
J Pressoti

(**) Term: **14 Years**

(57) **CLAIM**
The ornamental design for a crank handle with clutch, as
shown and described.

(21) Appl. No.: **29/375,340**

DESCRIPTION

(22) Filed: **Sep. 21, 2010**

FIG. 1 is a front perspective view showing the new design;
FIG. 2 is a rear perspective view thereof;
FIG. 3 is a front elevational view thereof;
FIG. 4 is a rear elevational view thereof;
FIG. 5 is a top plan view thereof; the bottom being a mirror
image;
FIG. 6 is side elevational view taken from the right of FIG. 1;
and,
FIG. 7 is a side elevational view taken from the left of FIG. 1.

(51) **LOC (9) Cl.** **22-01**

(52) **U.S. Cl.** **D22/107**

(58) **Field of Classification Search** D22/107,
D22/199; 124/23.1, 25.6, 86, 88; 446/572;
D6/552; D8/44, 313, 342, 394; 473/583–586
See application file for complete search history.

1 Claim, 5 Drawing Sheets

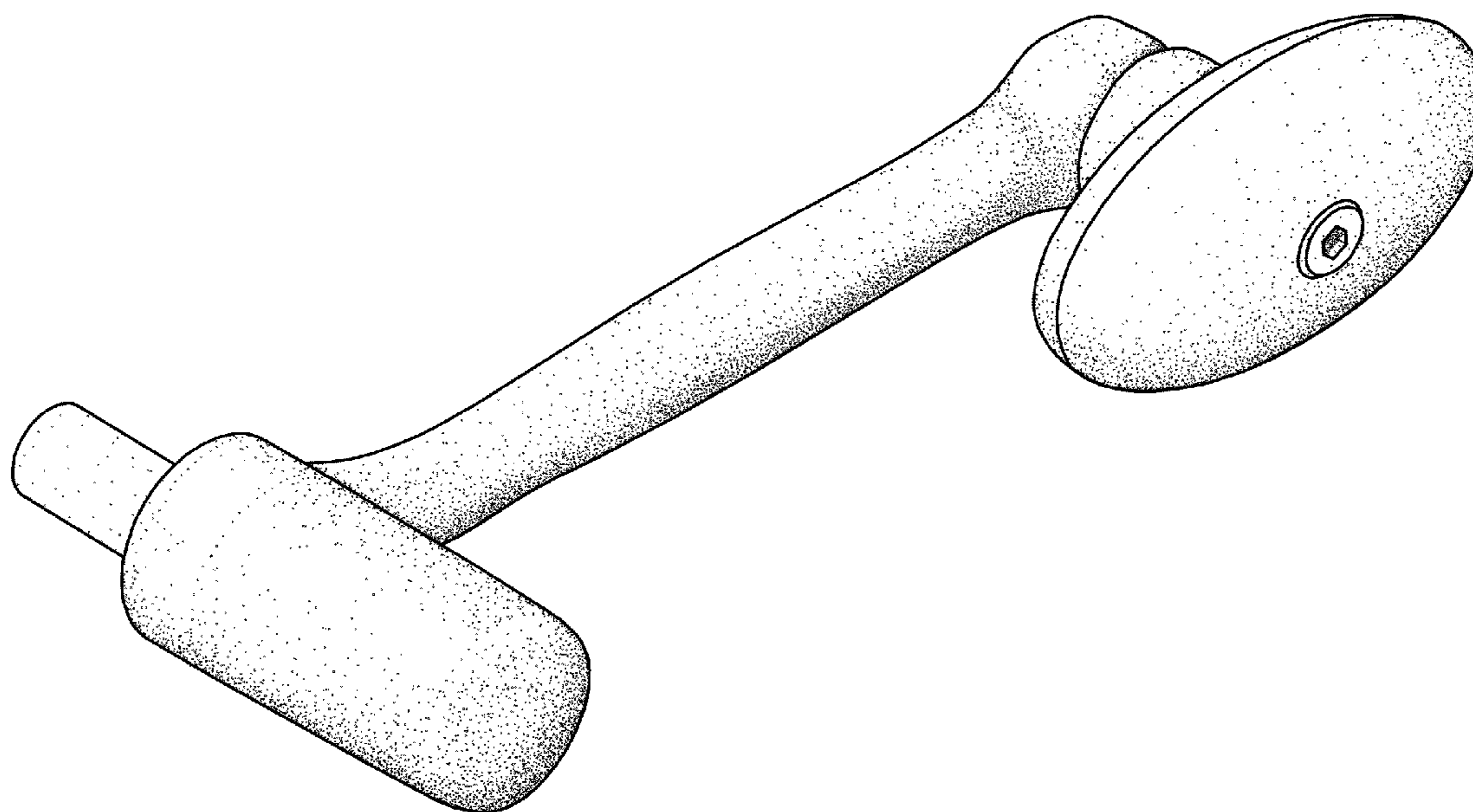

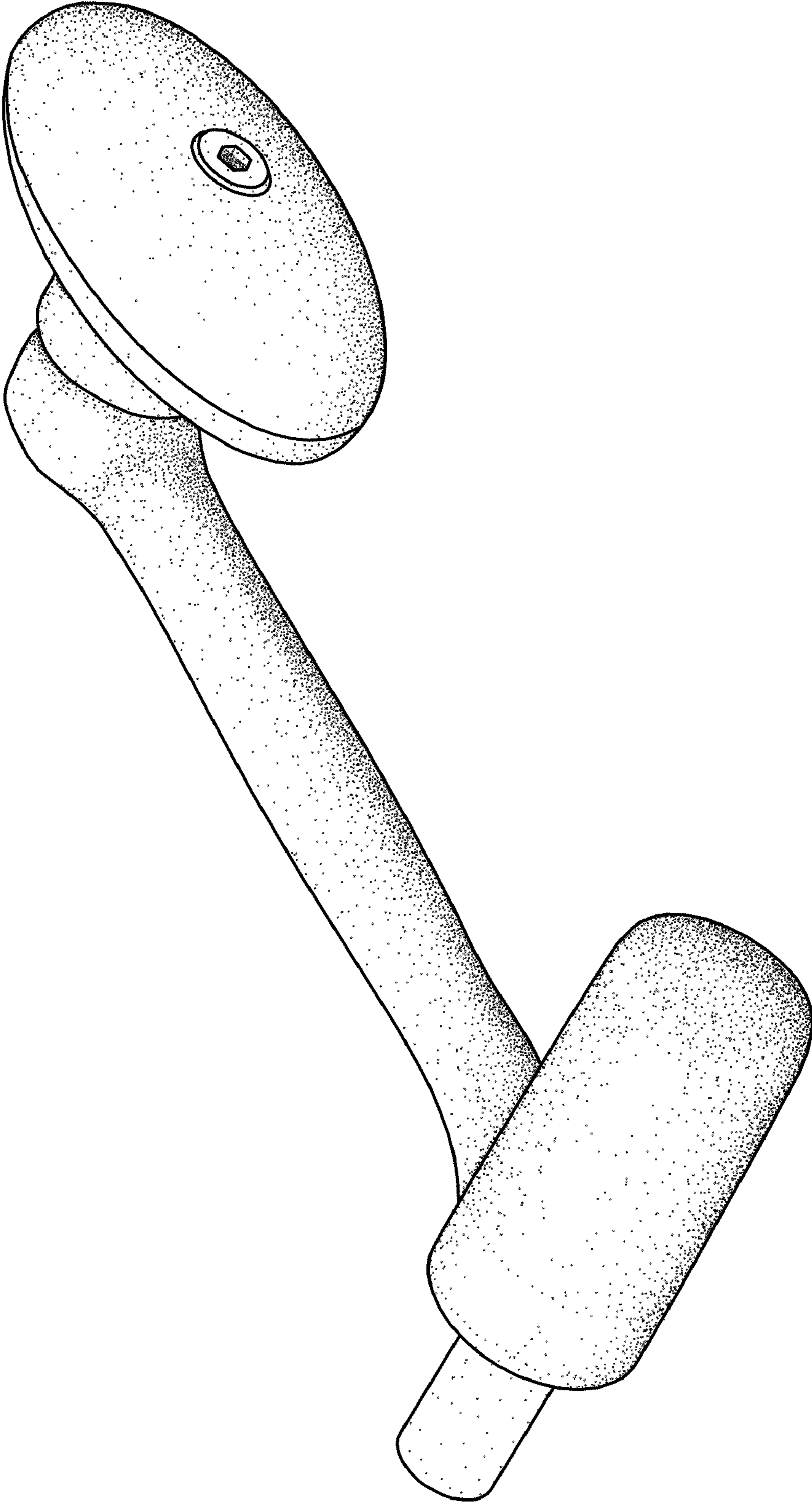

FIG.-1

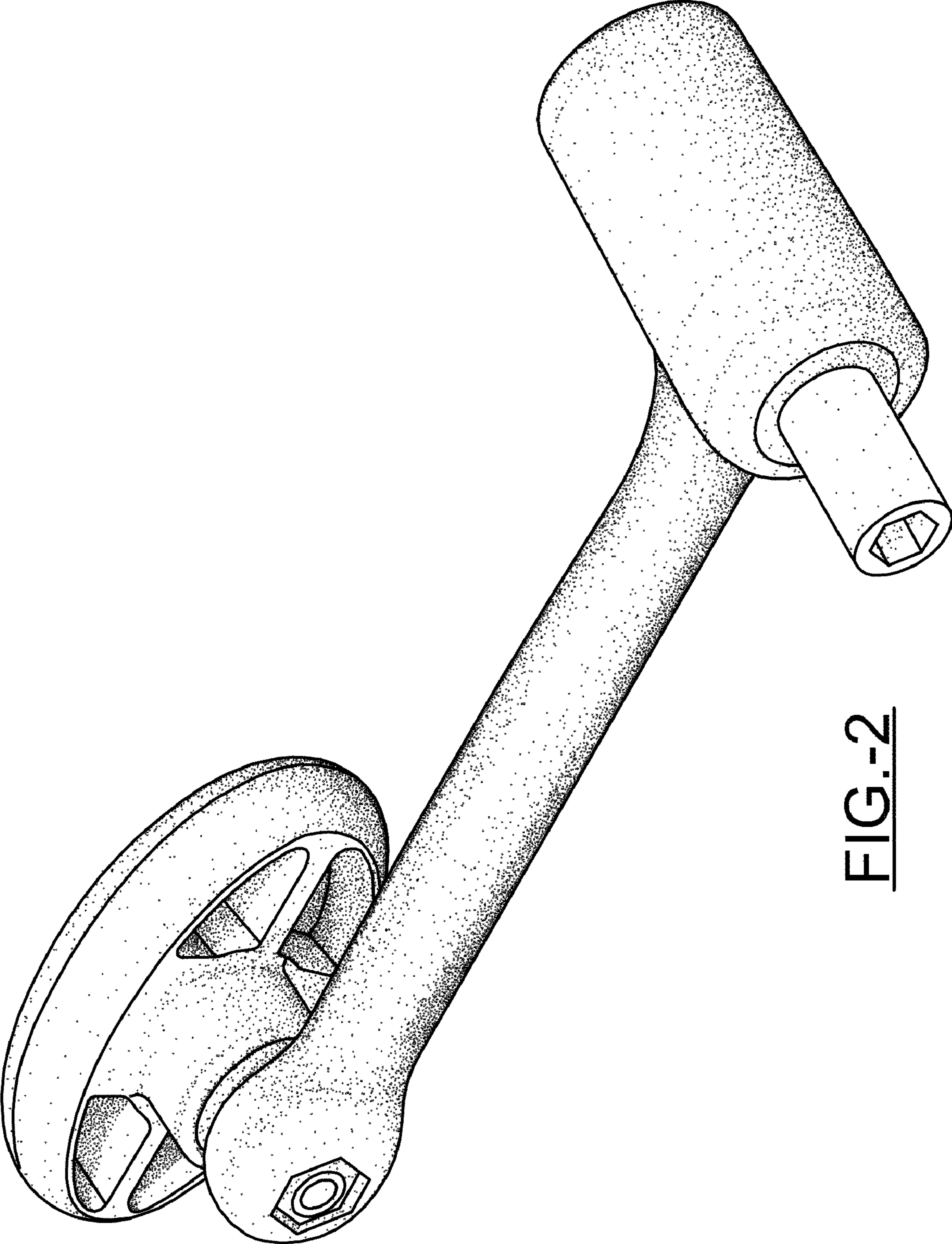

FIG.-2

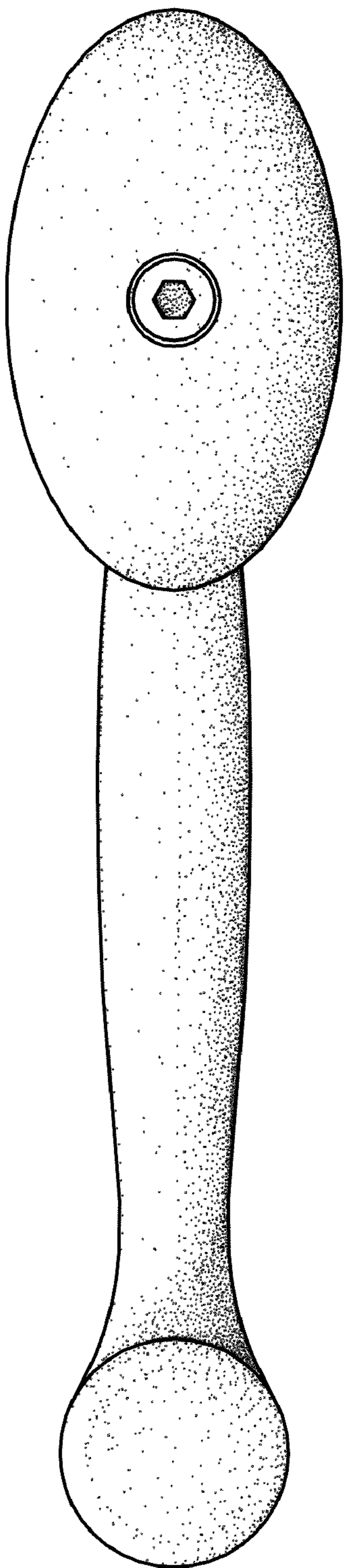

FIG.-3

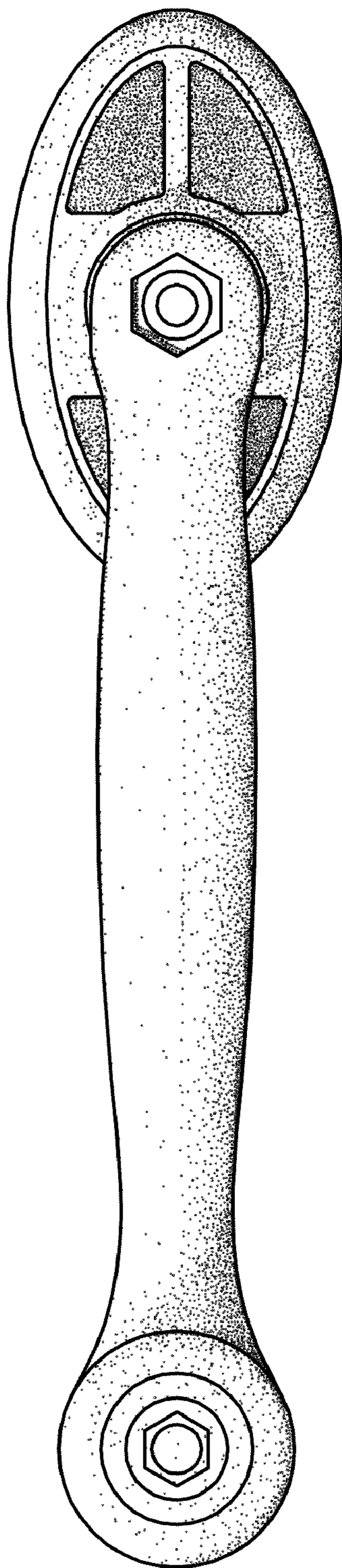

FIG.-4

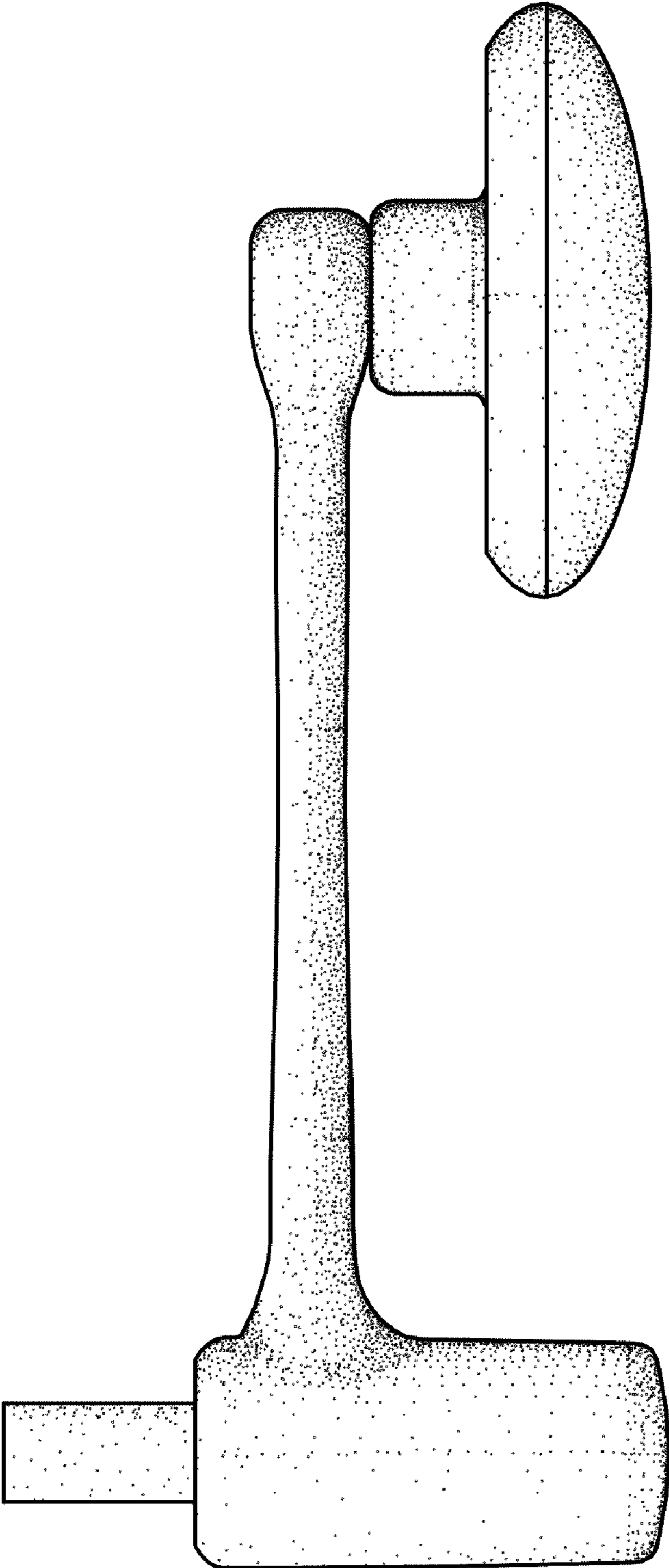

FIG.-5

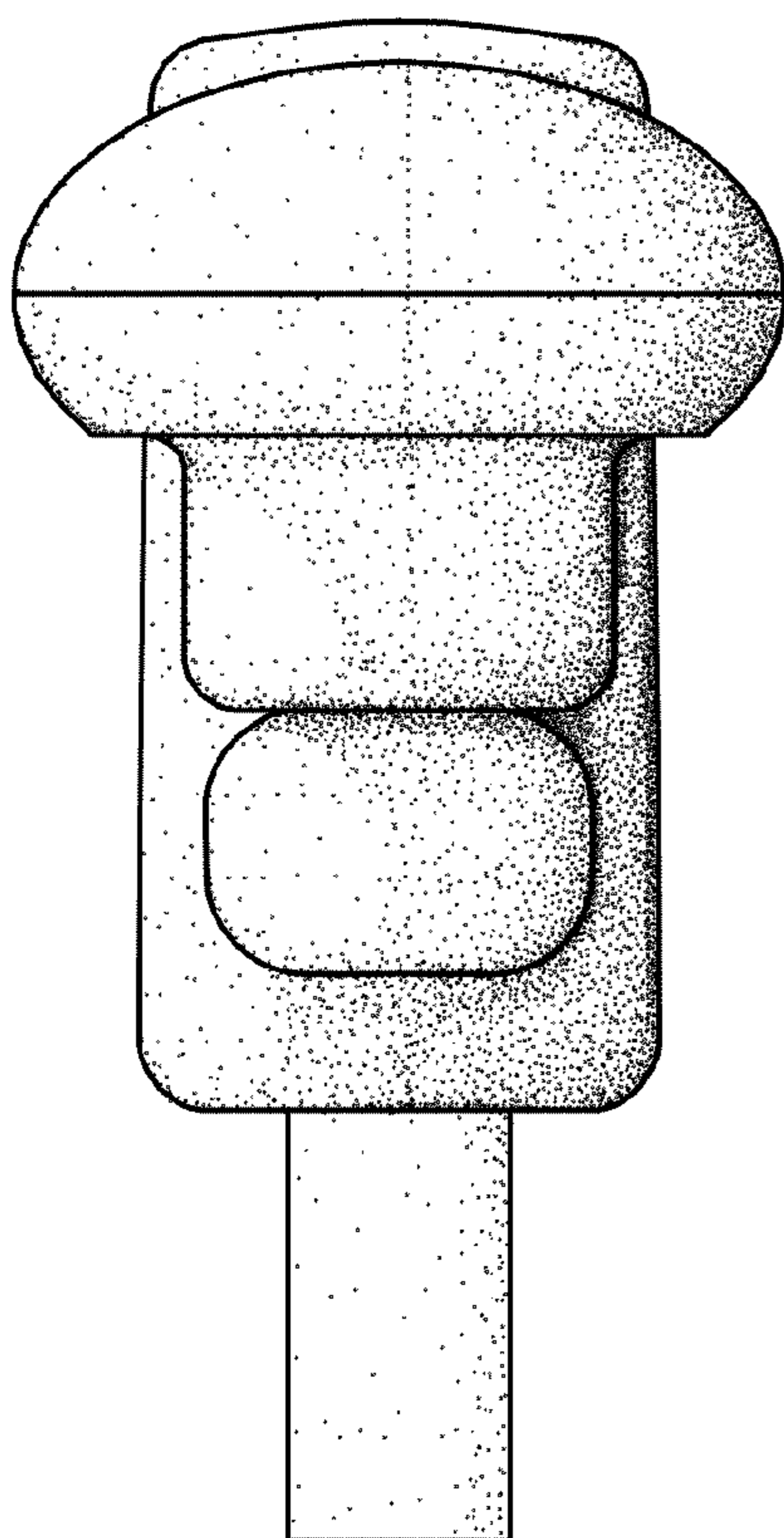

FIG.-6

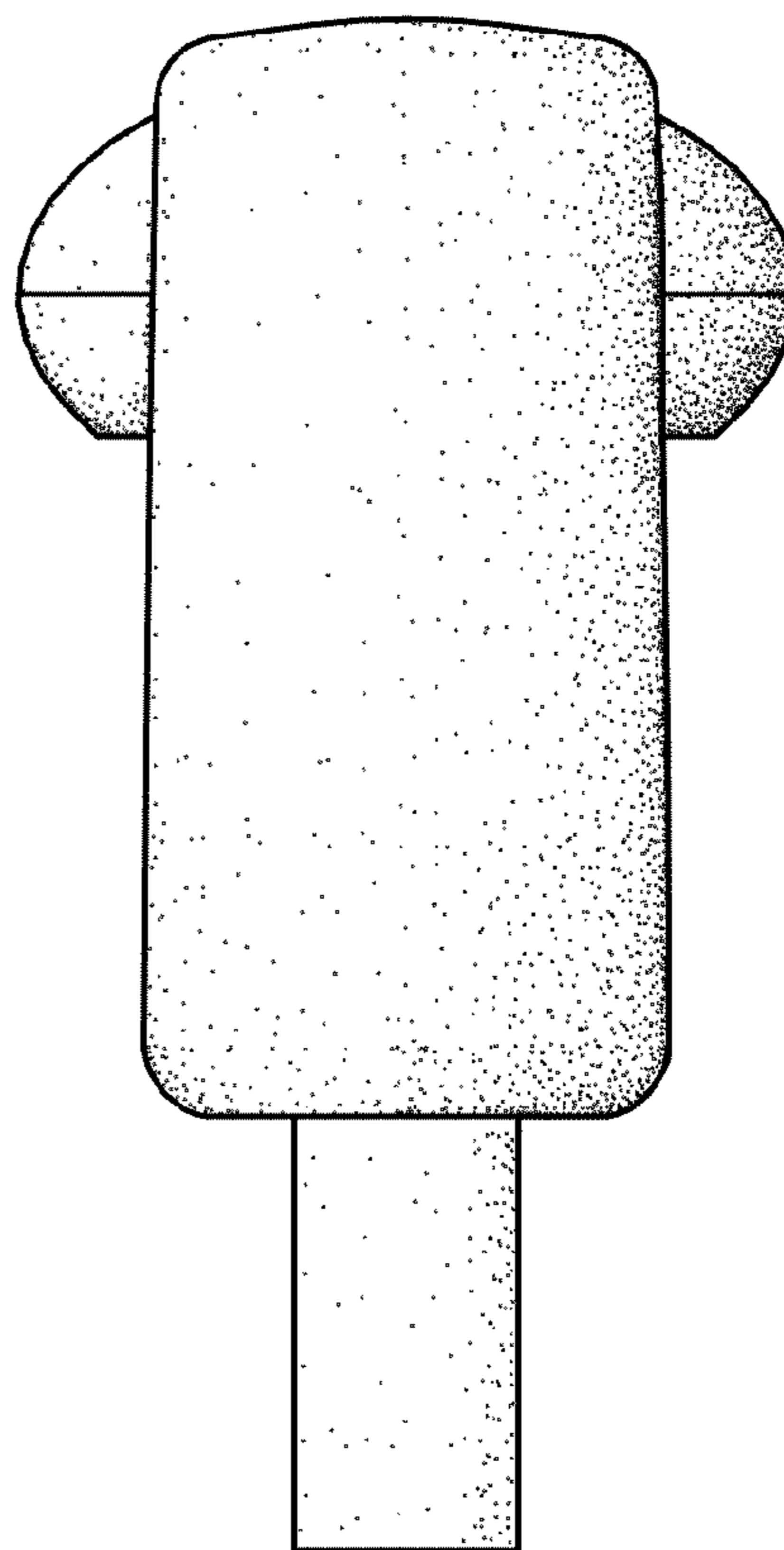

FIG.-7