



US00D655707S

(12) **United States Design Patent**
Miyauchi et al.

(10) **Patent No.:** **US D655,707 S**
(45) **Date of Patent:** **** Mar. 13, 2012**

(54) **INTERACTIVE PEN**

(75) Inventors: **Hiroto Miyauchi**, Matsumoto (JP);
Nobuyuki Otsuki, Matsumoto (JP)

(73) Assignee: **Seiko Epson Corporation**, Tokyo (JP)

(**) Term: **14 Years**

(21) Appl. No.: **29/405,320**

(22) Filed: **Nov. 1, 2011**

(30) **Foreign Application Priority Data**

Aug. 26, 2011 (JP) 2011-019388

(51) **LOC (9) Cl.** **14-02**

(52) **U.S. Cl.** **D14/411**

(58) **Field of Classification Search** D8/61;
D14/411; D19/35, 36, 41-51, 54-58; 401/55,
401/99, 100, 104-107, 196, 197, 202, 208,
401/209, 213, 192, 195, 243; 708/107; 345/179,
345/173; 178/19.01; 700/94

See application file for complete search history.

(56) **References Cited**

U.S. PATENT DOCUMENTS

- D200,732 S * 3/1965 Fischer D8/61
- D464,653 S * 10/2002 Nagai et al. D14/411
- D489,085 S * 4/2004 Willat et al. D19/36
- D499,447 S * 12/2004 Hui-Kuo D19/36
- D500,085 S * 12/2004 Cotter et al. D19/66
- D508,530 S * 8/2005 Qiu D19/51

- D527,050 S * 8/2006 Hirota D19/51
- D530,746 S * 10/2006 Gerules D19/45
- D533,590 S * 12/2006 Beyer D19/49
- D551,712 S * 9/2007 Bui et al. D19/51
- D565,653 S * 4/2008 Freed et al. D19/36
- D584,355 S * 1/2009 Hidaka et al. D19/51
- D600,357 S * 9/2009 Chaput D24/215
- D610,619 S * 2/2010 Fang D19/54
- D617,328 S * 6/2010 Nakata D14/411
- D623,187 S * 9/2010 Cacioppo et al. D14/411
- D623,225 S * 9/2010 Ryan D19/48
- D631,477 S * 1/2011 Cacioppo et al. D14/411
- D634,747 S * 3/2011 Wong et al. D14/411

* cited by examiner

Primary Examiner — Austin Murphy

(74) *Attorney, Agent, or Firm* — Oliff & Berridge, PLC

(57) **CLAIM**

The ornamental design for an interactive pen, as shown and described.

DESCRIPTION

FIG. 1 is a top, front, left-side perspective view of an interactive pen;
 FIG. 2 is a top, rear, right-side perspective view thereof;
 FIG. 3 is front view thereof;
 FIG. 4 is a rear view thereof;
 FIG. 5 is a left-side view thereof;
 FIG. 6 is a right-side view thereof;
 FIG. 7 is a top view thereof; and,
 FIG. 8 is a bottom view thereof.

1 Claim, 3 Drawing Sheets

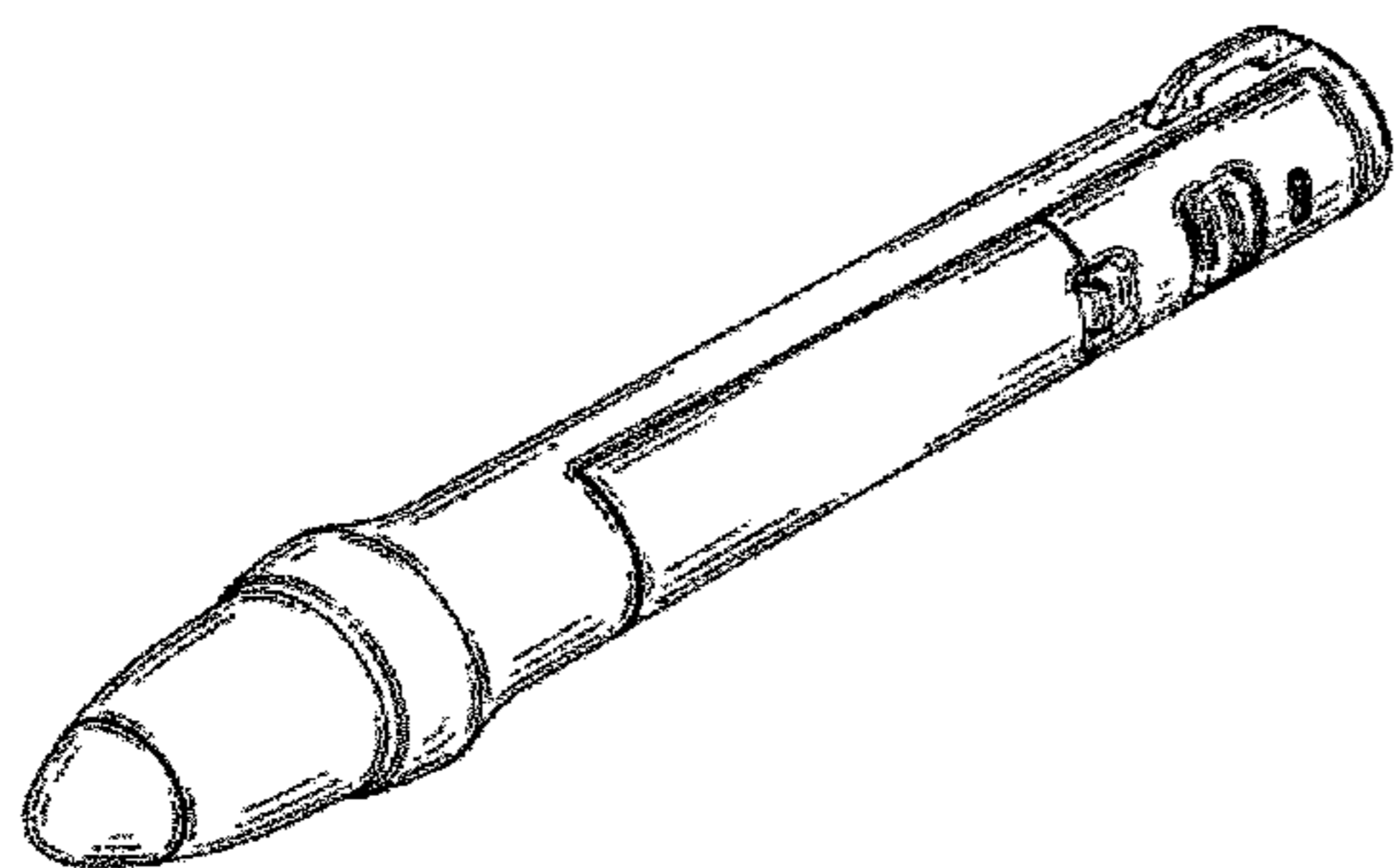

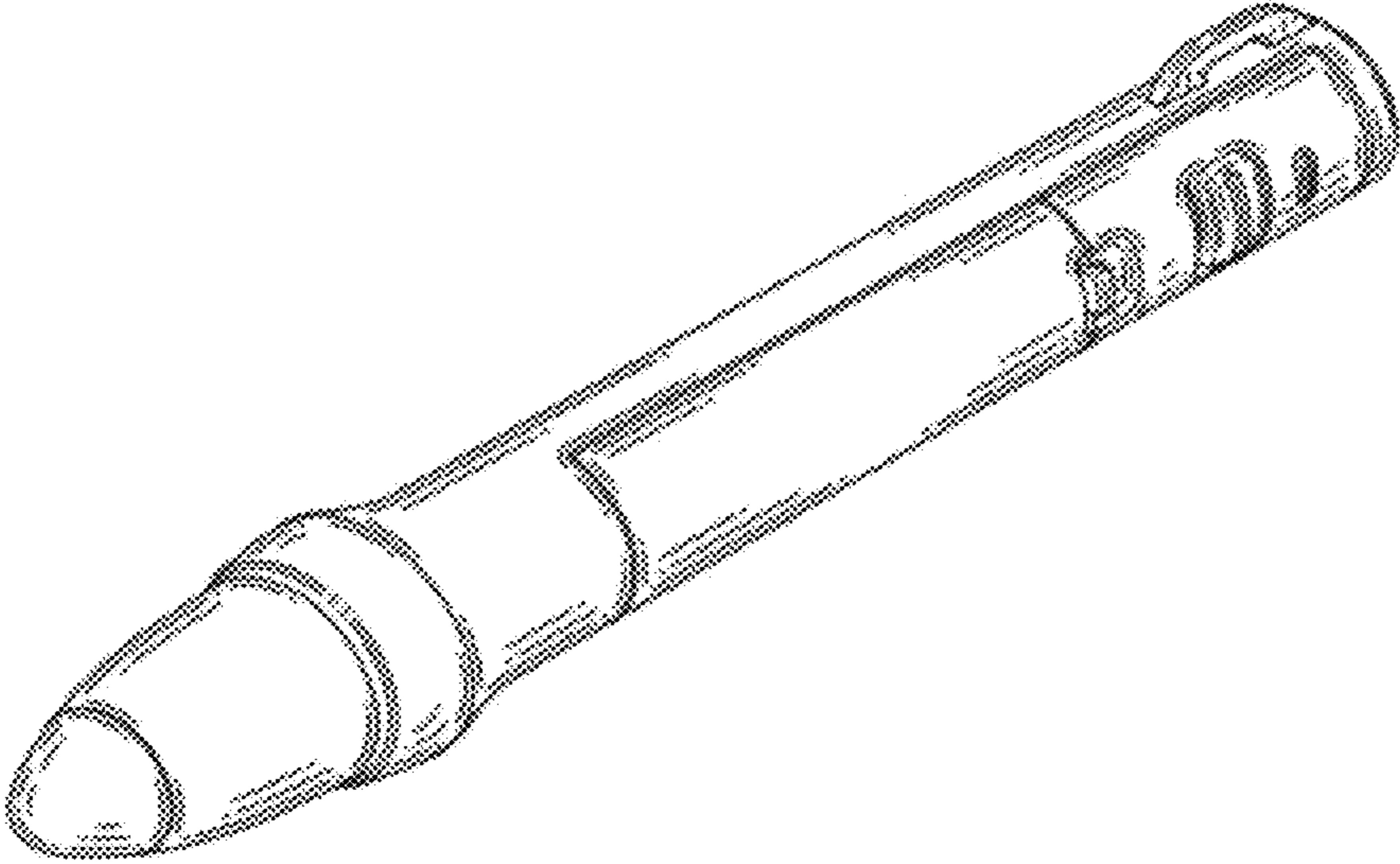

FIG. 1

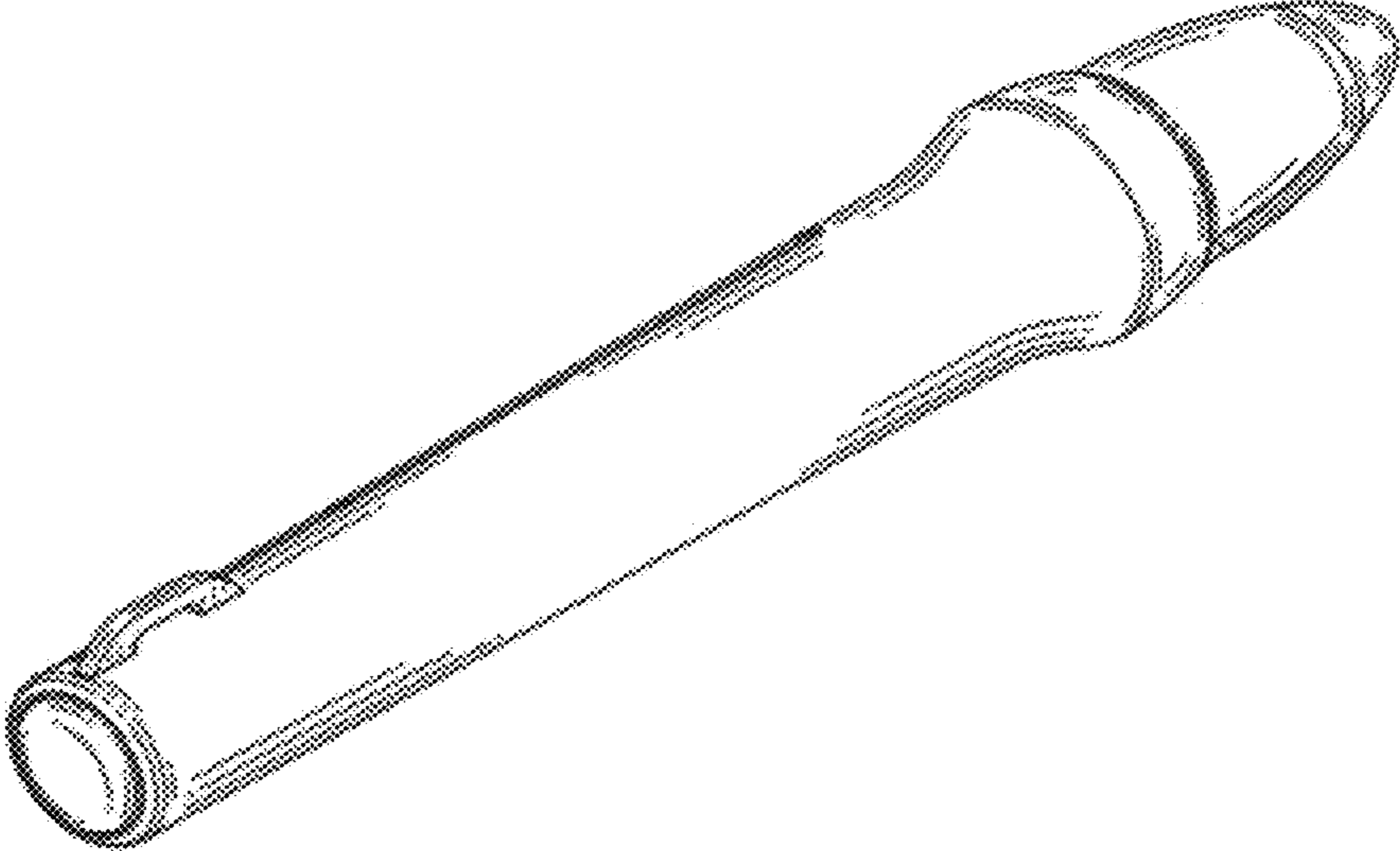

FIG. 2

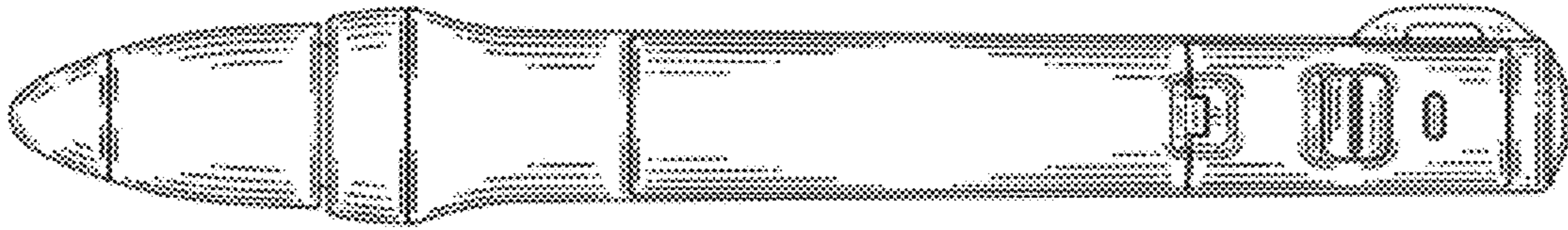

FIG. 3

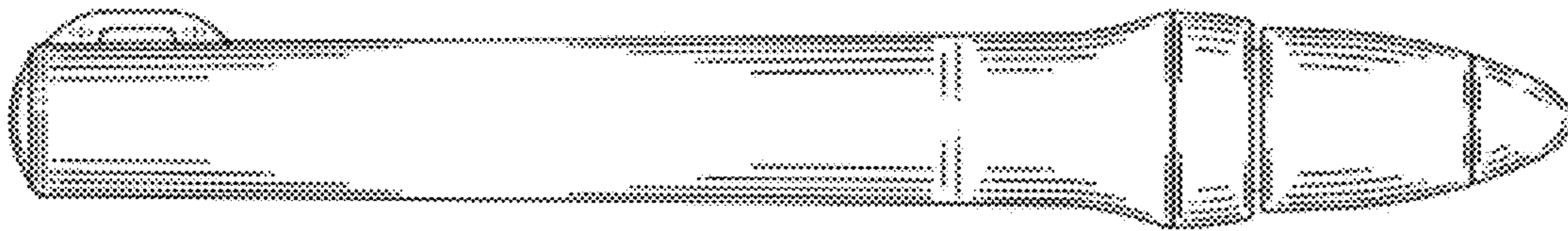

FIG. 4

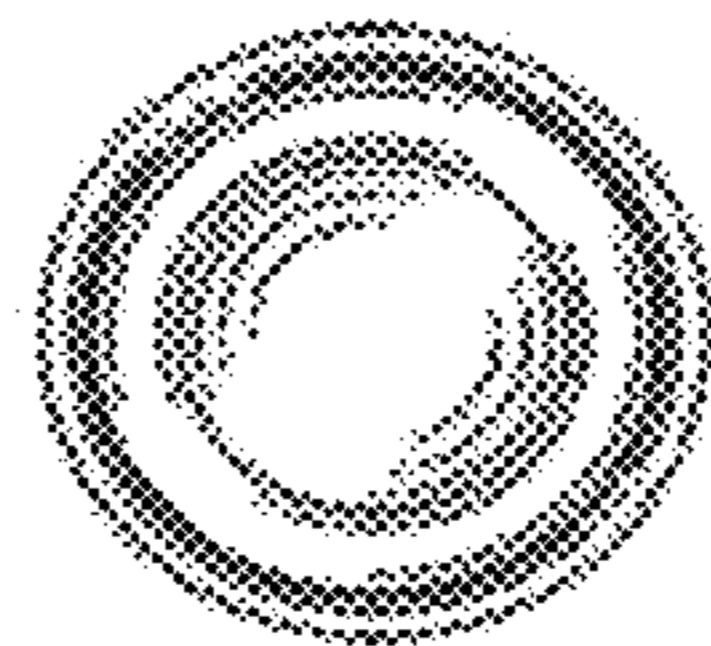

FIG. 5

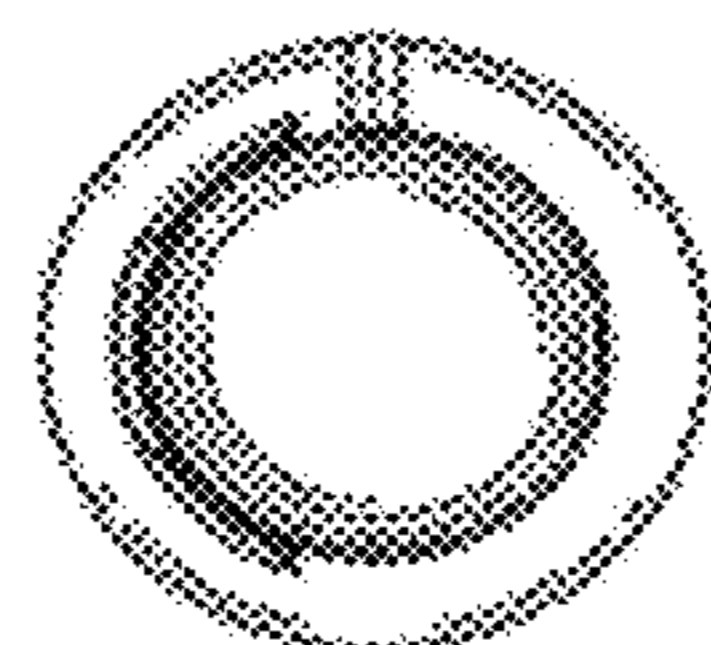

FIG. 6

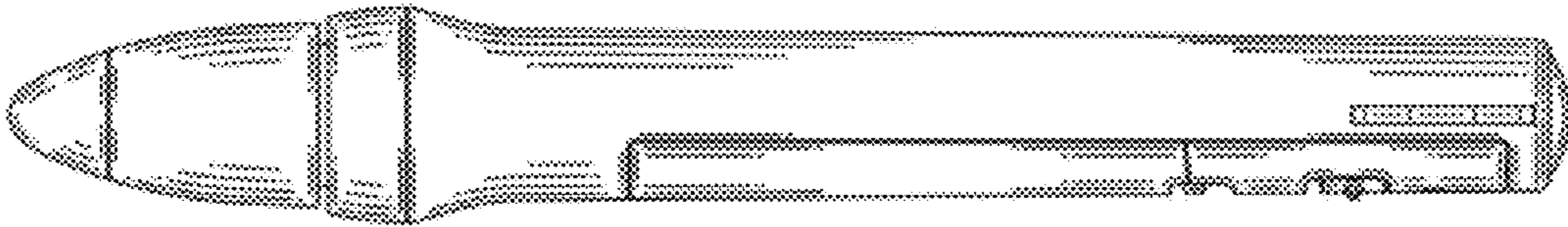

FIG. 7

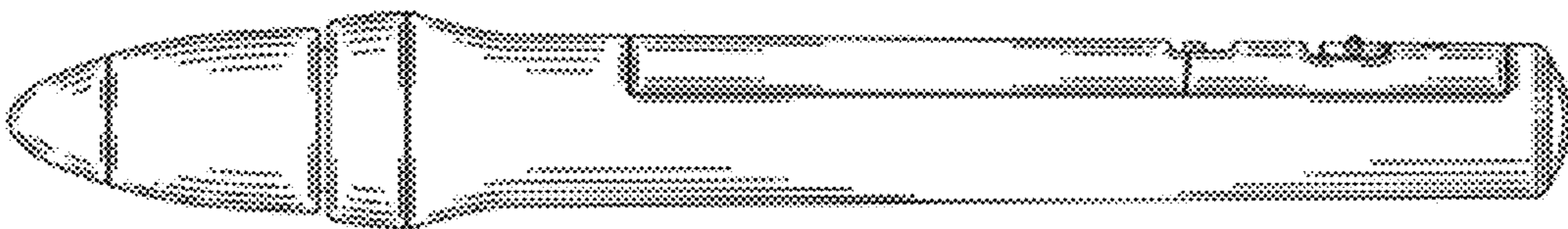

FIG. 8