



US00D655619S

(12) **United States Design Patent**
Soliman

(10) **Patent No.:** **US D655,619 S**
(45) **Date of Patent:** **** Mar. 13, 2012**

- (54) **PLASTIC AEROSOL CONTAINER**
- (76) Inventor: **Atef Gabr Soliman**, Cairo (EG)
- (**) Term: **14 Years**
- (21) Appl. No.: **29/387,508**
- (22) Filed: **Mar. 14, 2011**

- D519,384 S 4/2006 Voss et al.
- D543,462 S 5/2007 Pedmo et al.
- D565,961 S 4/2008 Dellevigne
- D574,252 S 8/2008 Ryan et al.
- 7,540,397 B2 6/2009 Muderlak et al.
- 2004/0050874 A1 3/2004 Blanchester
- 2007/0245538 A1 10/2007 Salameh
- 2009/0176683 A1 7/2009 Choe et al.
- 2011/0017701 A1 1/2011 Soliman

Related U.S. Application Data

- (63) Continuation-in-part of application No. 29/349,353, filed on Mar. 25, 2010, now abandoned.
 - (51) **LOC (9) Cl.** **09-01**
 - (52) **U.S. Cl.** **D9/690**
 - (58) **Field of Classification Search** D9/682-694, D9/500-505, 516-575, 435, 436, 447-450; 215/370-385; 220/600, 604-609, 669-675; 222/129, 135, 153.01, 153.03, 153.04, 153.09, 222/153.11-153.14, 182, 183, 631, 635, 222/209-213, 215, 321.7-321.9, 372, 373, 222/378, 379, 383.1, 384-386, 398, 400.7, 222/400.8, 401, 402.1-402.25
- See application file for complete search history.

FOREIGN PATENT DOCUMENTS

EG 20060120655 12/2006

OTHER PUBLICATIONS

British Standard, "Specification for Non-refillable plastics aerosol dispensers up to 1000 mL capacity," BS 5597:1991.

* cited by examiner

Primary Examiner — Catherine Tuttle
(74) *Attorney, Agent, or Firm* — Ballard Spahr LLP

(57) **CLAIM**

I claim the ornamental design for a plastic aerosol container, as shown and described.

DESCRIPTION

FIG. 1 is a front view of the body portion of my new design for a plastic aerosol container shown separated from the dispenser cap for a clear disclosure of the appearance of the rim; FIG. 2 is a right side view thereof; FIG. 3 is a bottom view thereof; FIG. 4 is a bottom perspective view thereof; FIG. 5 is a front view of the assembled design; FIG. 6 is a rear view thereof; FIG. 7 is a right side view thereof; and, FIG. 8 is a perspective view thereof.

1 Claim, 8 Drawing Sheets

(56) **References Cited**

U.S. PATENT DOCUMENTS

- 3,272,390 A * 9/1966 Horwitt 222/153.11
- 3,306,497 A * 2/1967 Kenney et al. 222/182
- D208,886 S 10/1967 Vuilleminot et al.
- D228,547 S 10/1973 Grothoff
- 4,065,036 A * 12/1977 Kirk, Jr. 222/153.13
- D255,012 S 5/1980 Ostrowsky
- 5,454,481 A 10/1995 Hsu
- 5,906,286 A 5/1999 Matsuno et al.
- D482,623 S 11/2003 Martin
- D510,031 S 9/2005 Slat et al.

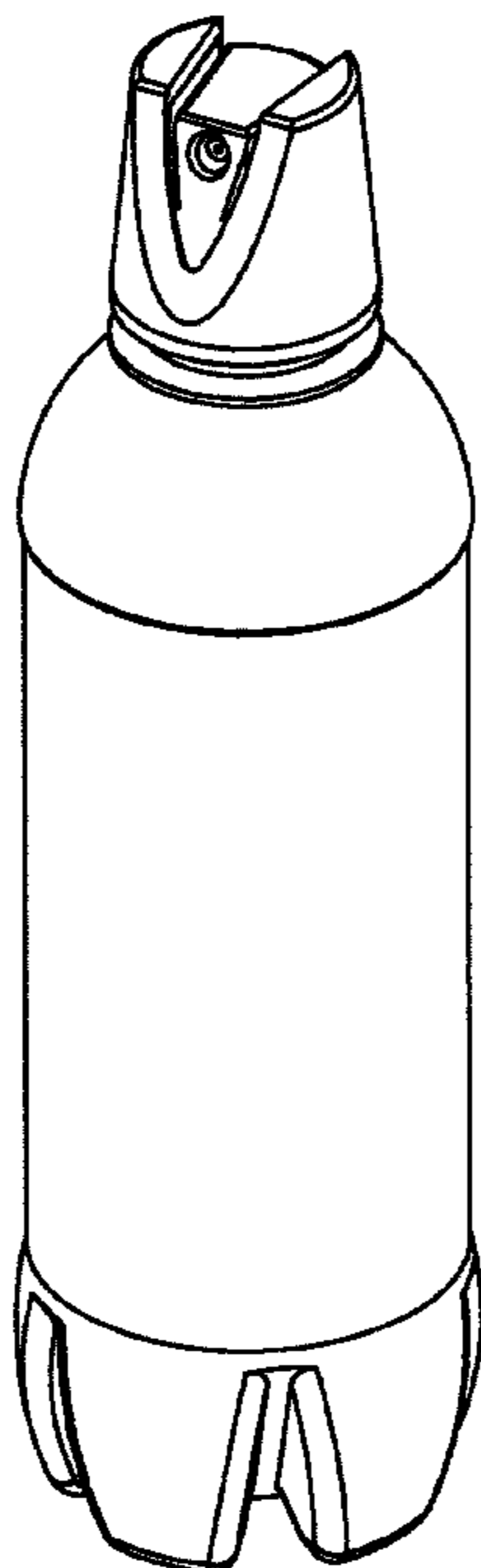

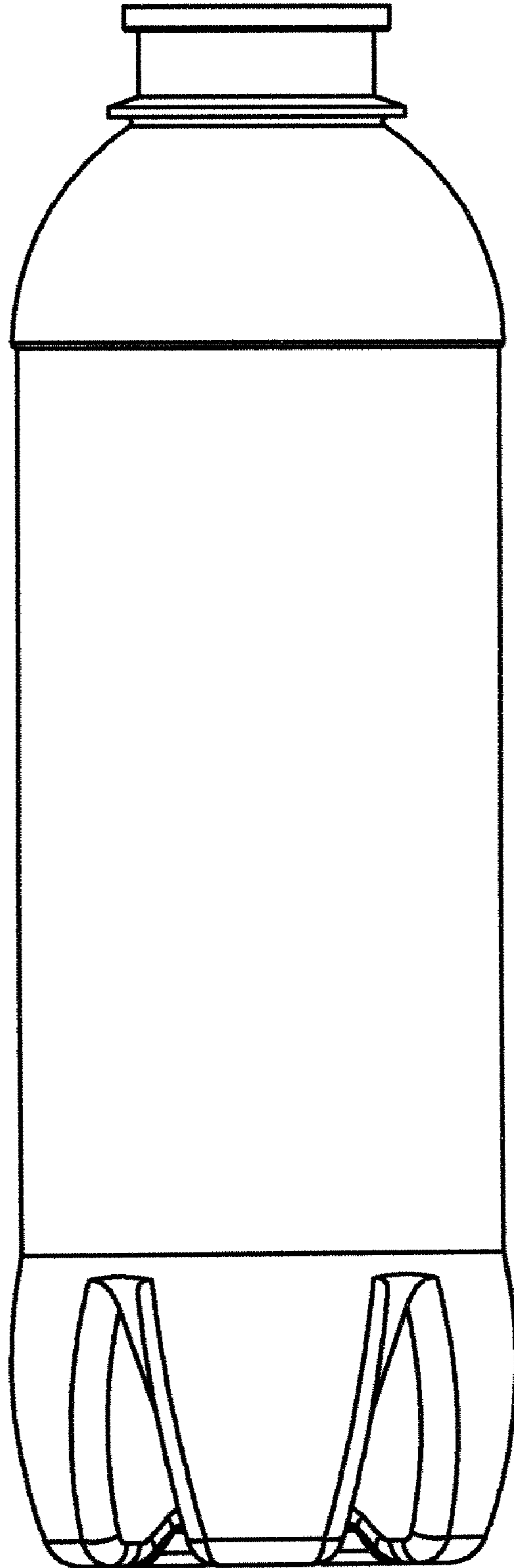

FIG. 1

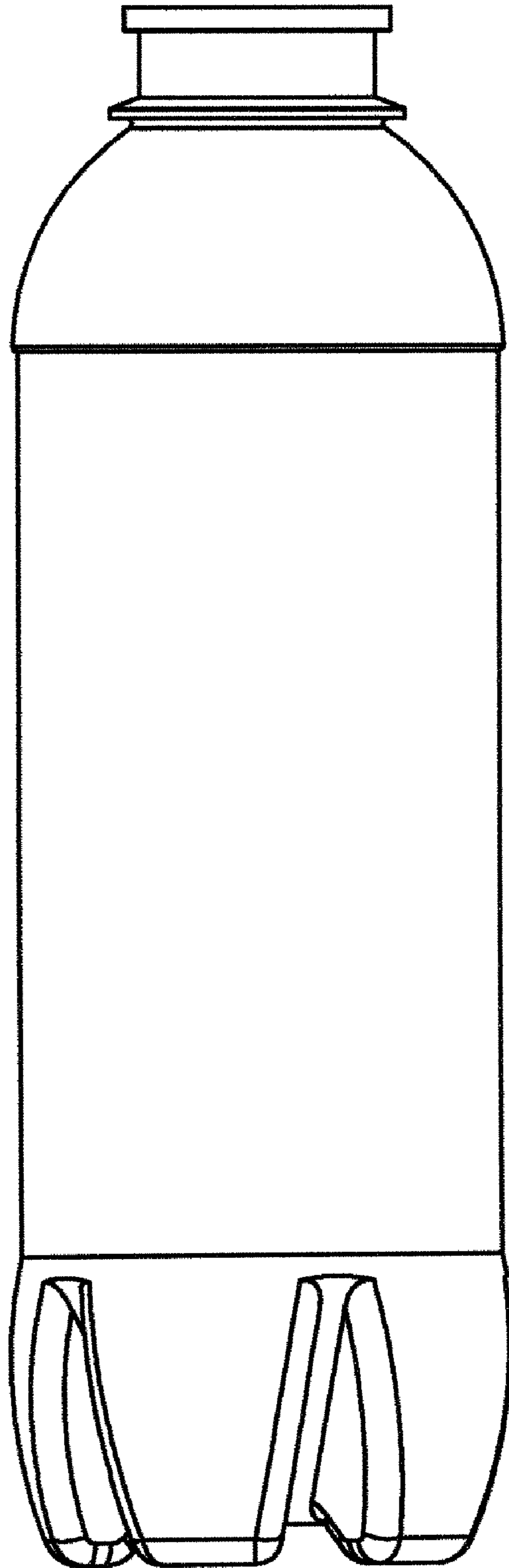

FIG. 2

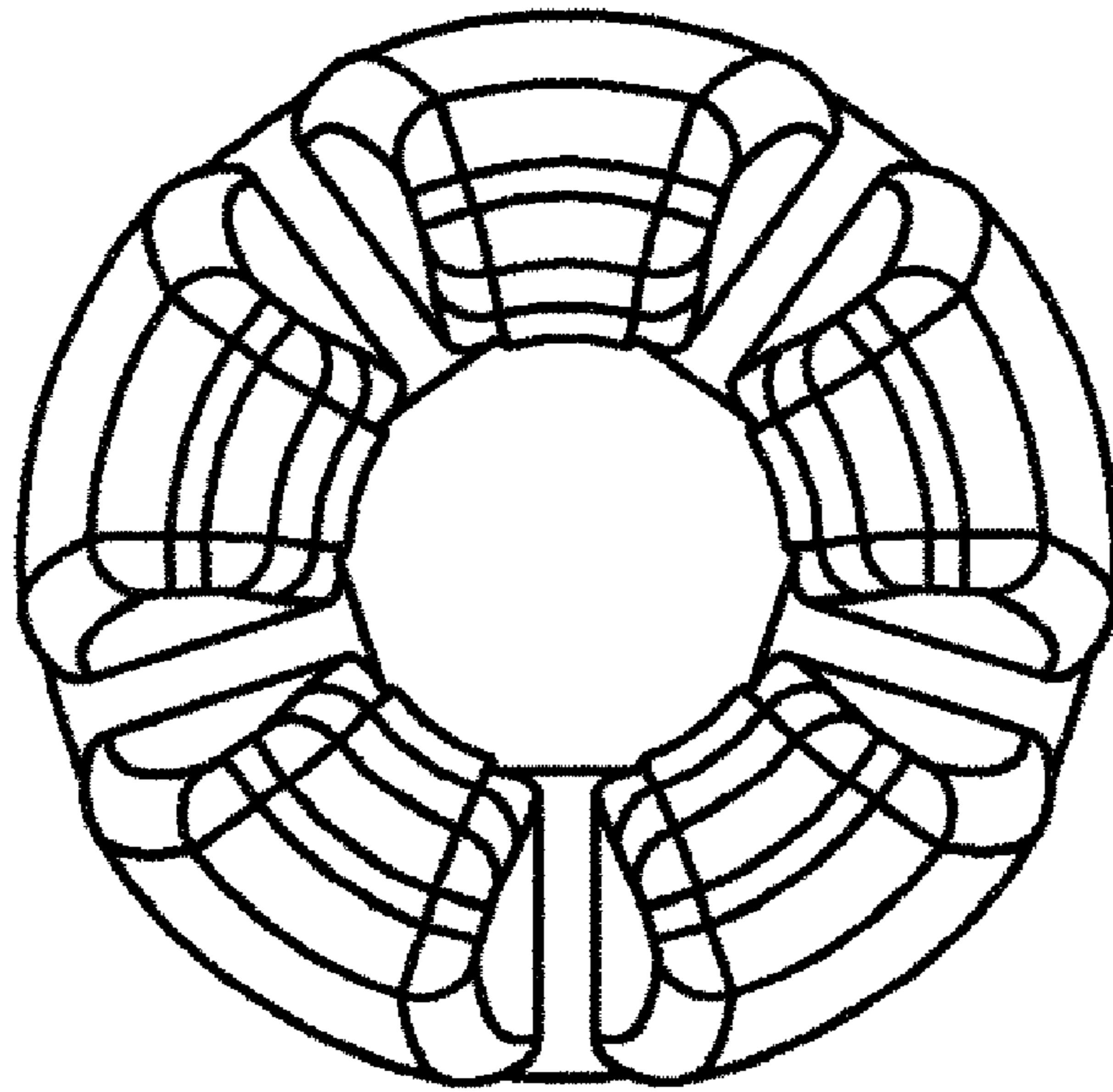

FIG. 3

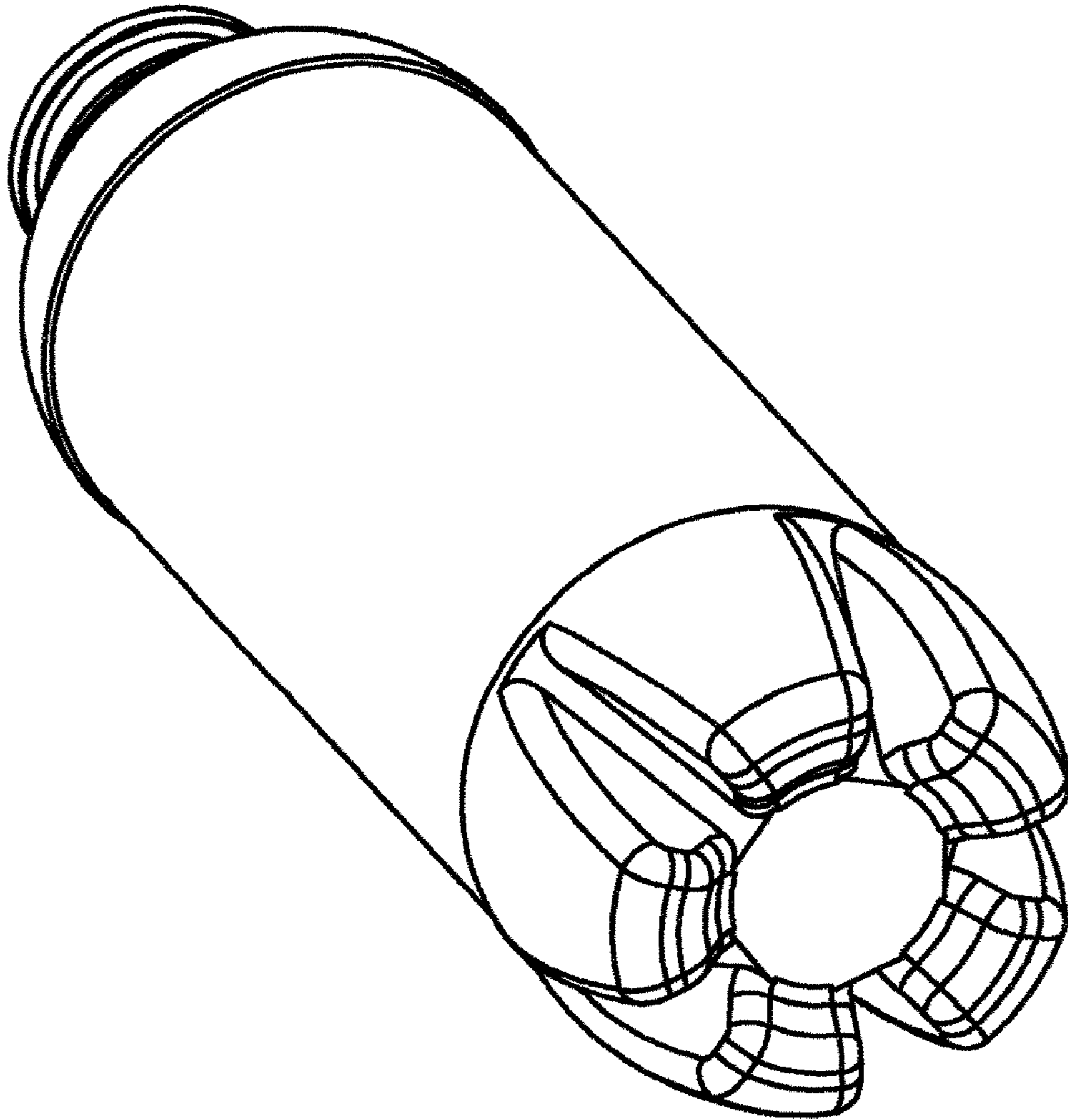

FIG. 4

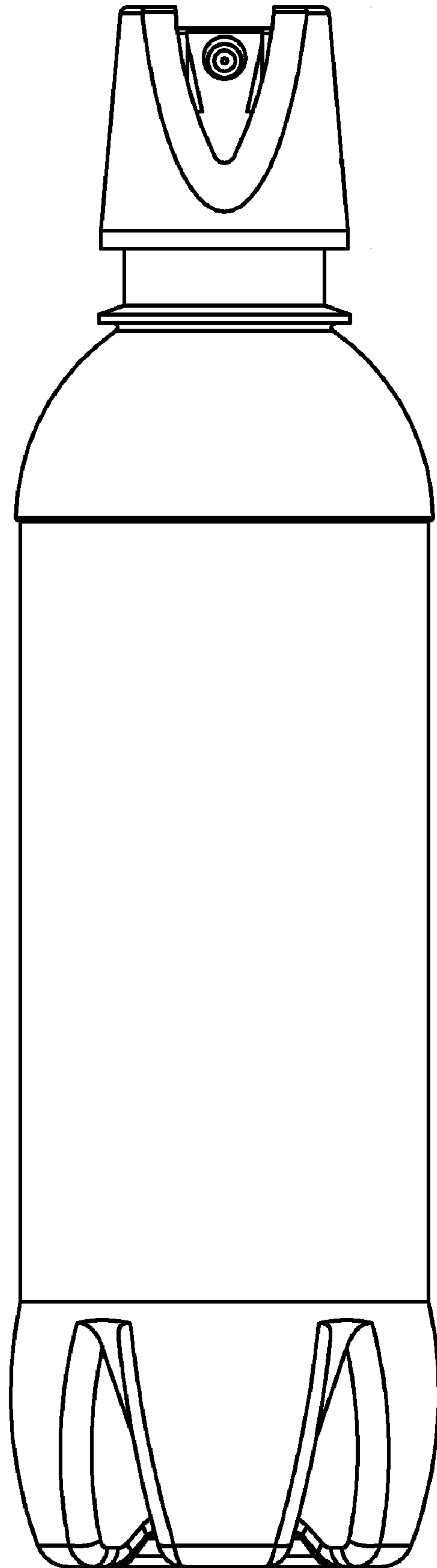

FIG. 5

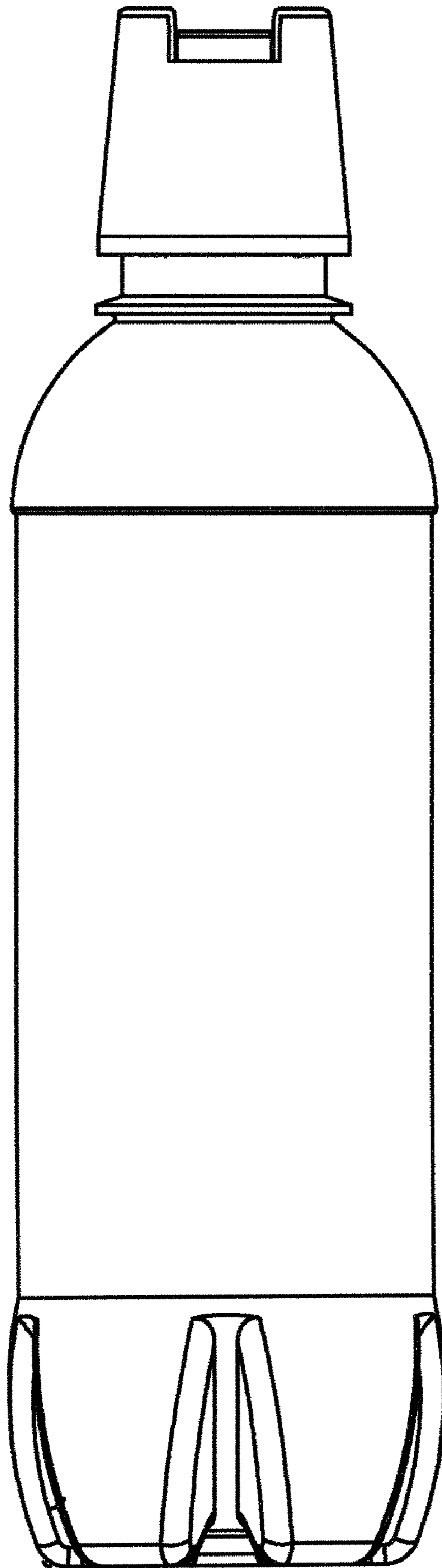

FIG. 6

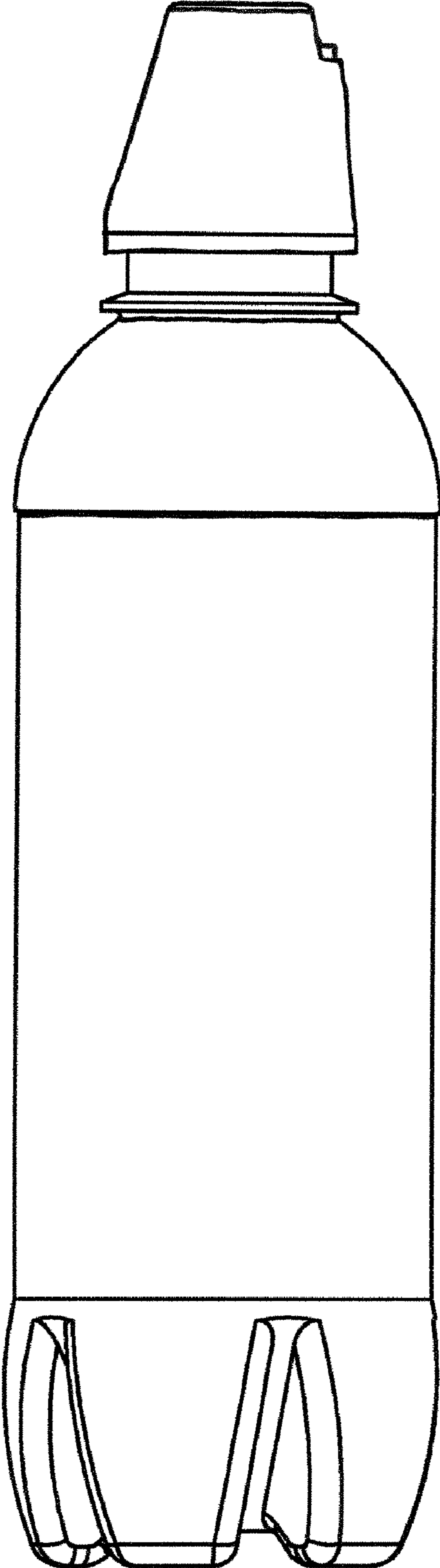

FIG. 7

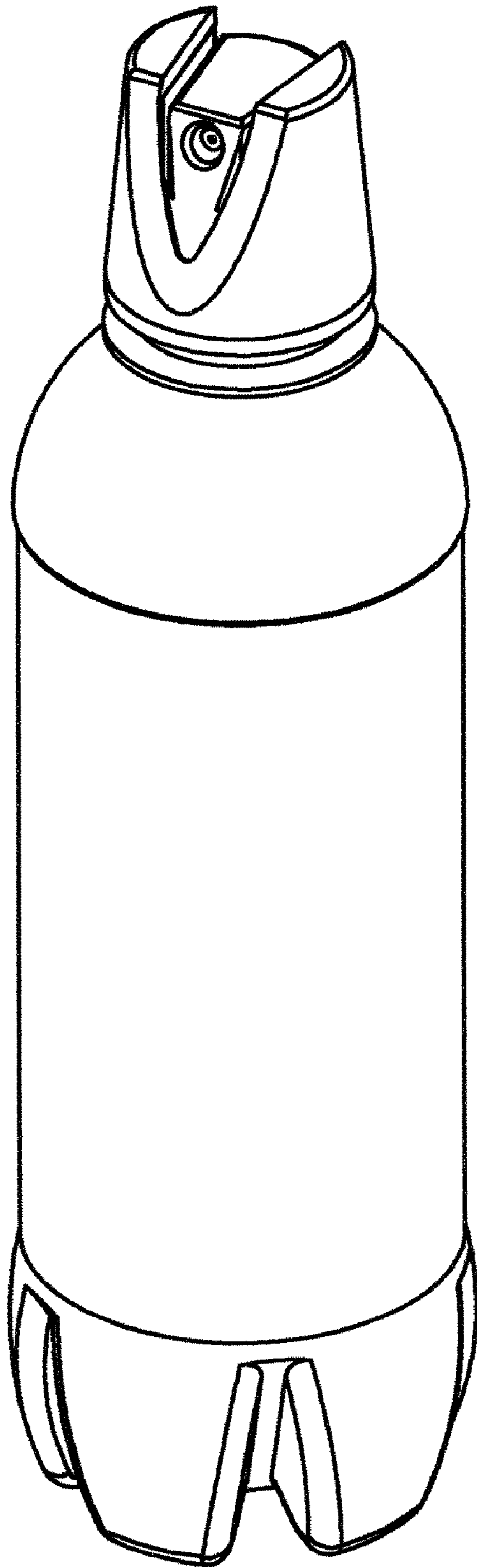

FIG. 8