



US00D655571S

(12) **United States Design Patent**  
**Tuttle**

(10) **Patent No.:** **US D655,571 S**  
(45) **Date of Patent:** **\*\* Mar. 13, 2012**

(54) **REUSABLE BOTTLE**

(76) Inventor: **Christopher Tuttle**, Portland, OR (US)

(\*\*) Term: **14 Years**

(21) Appl. No.: **29/401,482**

(22) Filed: **Sep. 12, 2011**

(51) **LOC (9) Cl.** ..... **07-01**

(52) **U.S. Cl.** ..... **D7/510**

(58) **Field of Classification Search** ..... D7/510,  
D7/511, 500, 532, 900, 507; 215/121, 382,  
215/388, 387; 220/674, 715, 713, 718, 592.16,  
220/592.17, 709, 708; D9/529, 500, 539  
See application file for complete search history.

(56) **References Cited**

**U.S. PATENT DOCUMENTS**

D240,018 S *	5/1976	Reynolds	.....	D9/500
5,178,816 A *	1/1993	Suzuki et al.	.....	264/530
D434,323 S *	11/2000	Pattison	.....	D9/772
D451,807 S *	12/2001	Goettner	.....	D9/504
D556,576 S *	12/2007	Webb	.....	D9/500
D605,517 S *	12/2009	Caldwell	.....	D9/500

D608,202 S \* 1/2010 Caroen et al. .... D9/500  
\* cited by examiner

*Primary Examiner* — Cynthia Underwood  
(74) *Attorney, Agent, or Firm* — Alleman Hall McCoy  
Russell & Tuttle LLP

(57) **CLAIM**

The ornamental design for a reusable bottle, as shown and described.

**DESCRIPTION**

FIG. 1. is a front view of a reusable bottle according to the present invention.

FIG. 2 is a top view of the reusable bottle of FIG. 1.

FIG. 3 is a bottom view of the reusable bottle of FIG. 1.

FIG. 4 is a front view of the reusable bottle of FIG. 1.

FIG. 5 is a right side view of the reusable bottle of FIG. 1.

FIG. 6 is a back view of the reusable bottle of FIG. 1; and,

FIG. 7 is a left side view of the reusable bottle of FIG. 1.

The broken lines in the figures are for environmental purposes only and form no part of the claimed design.

**1 Claim, 3 Drawing Sheets**

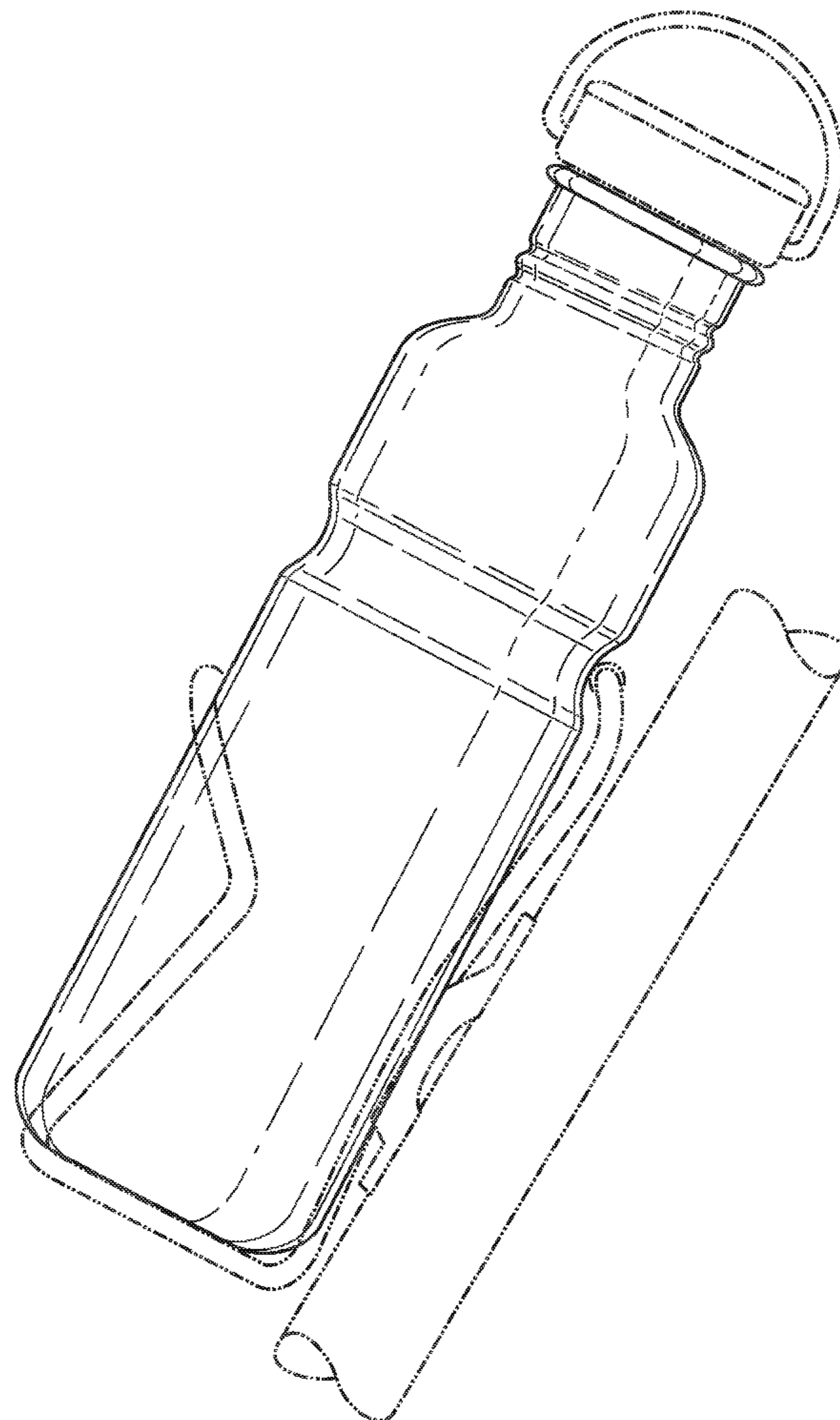

Fig. 2

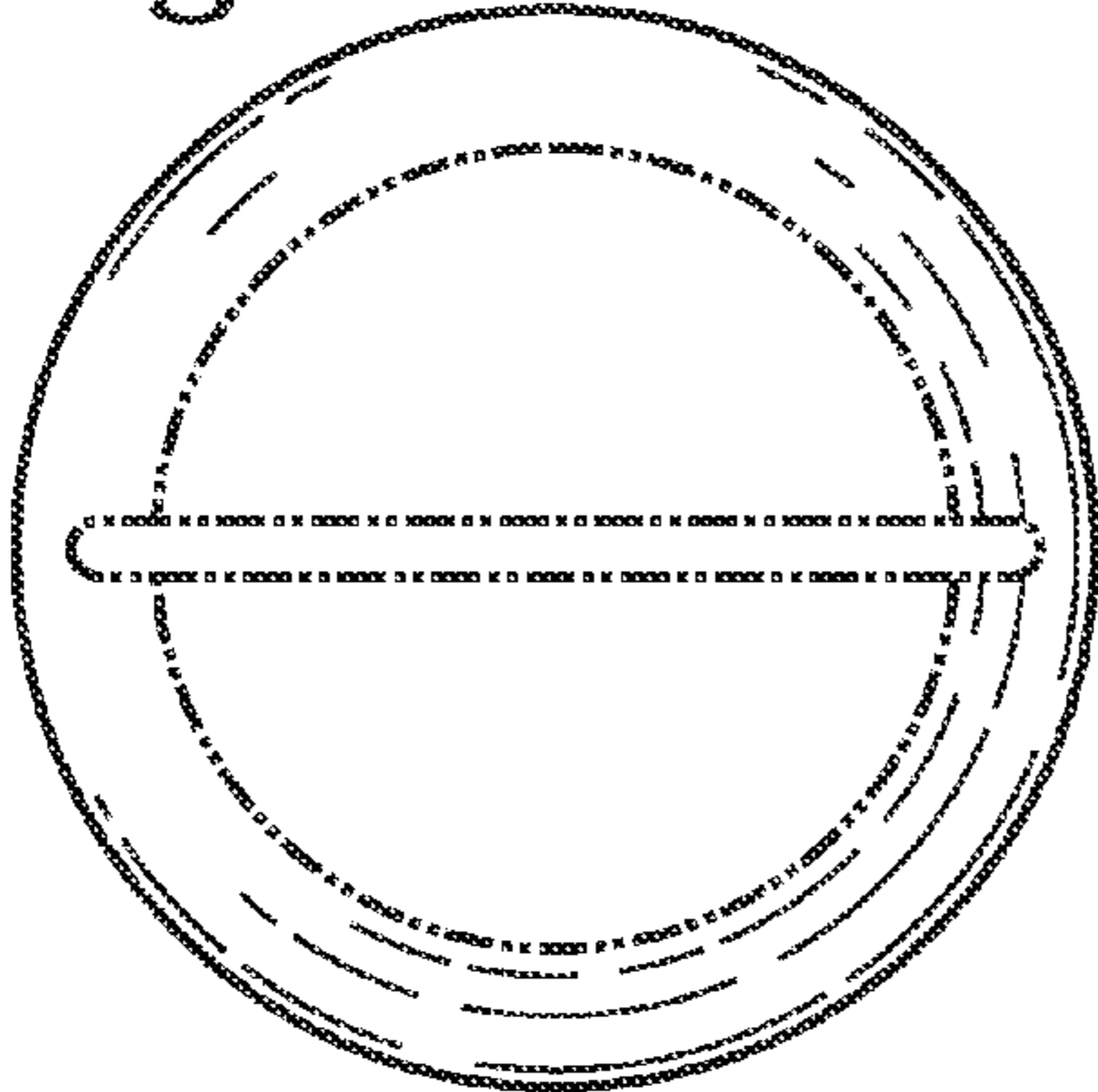

Fig. 1

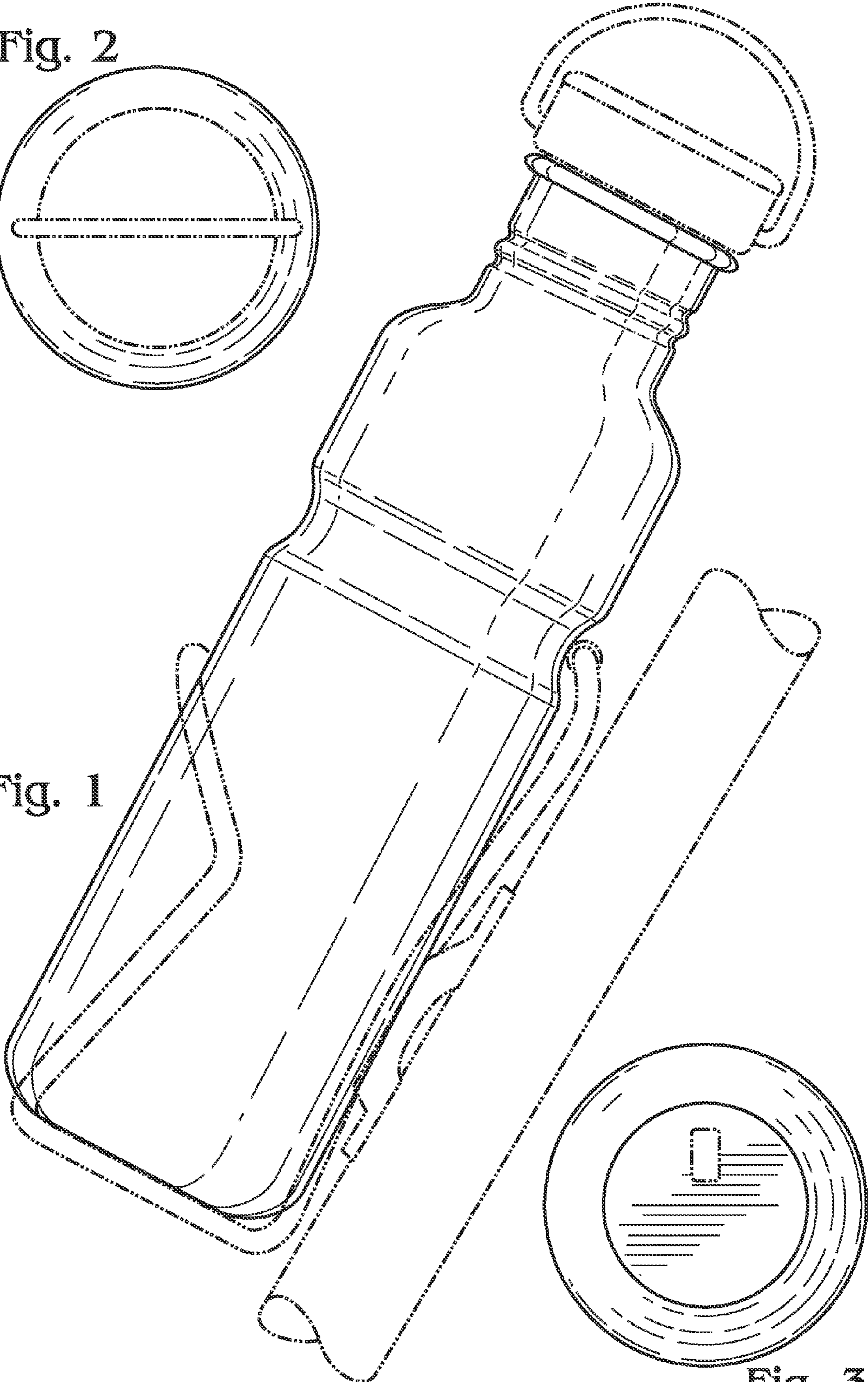

Fig. 3

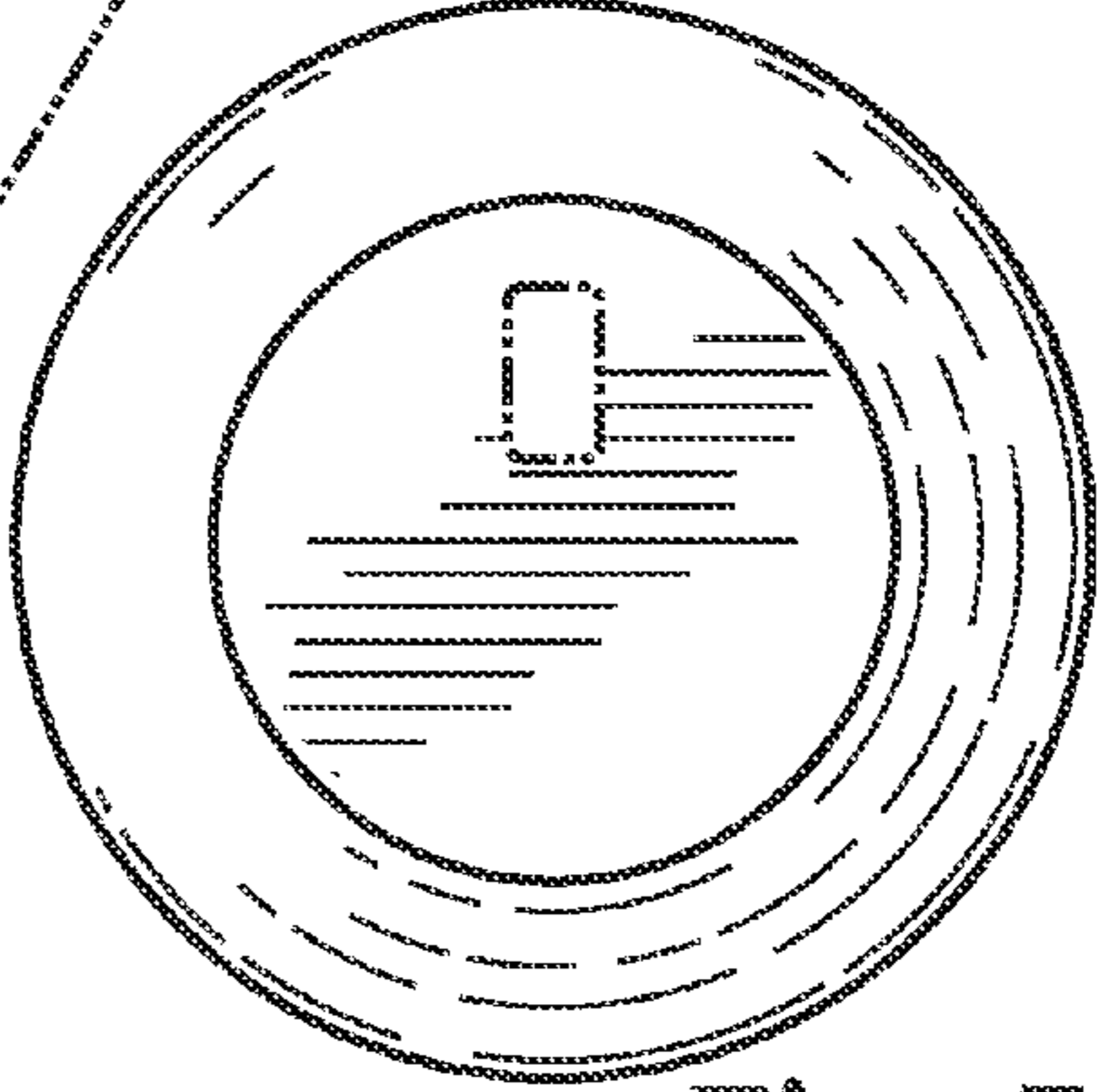

Fig. 4

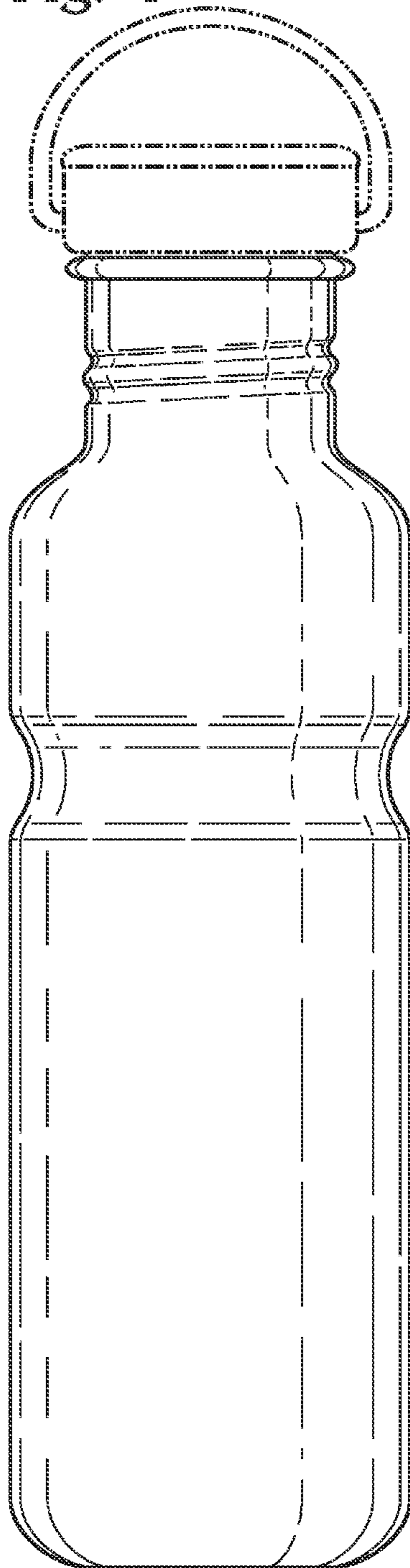

Fig. 5

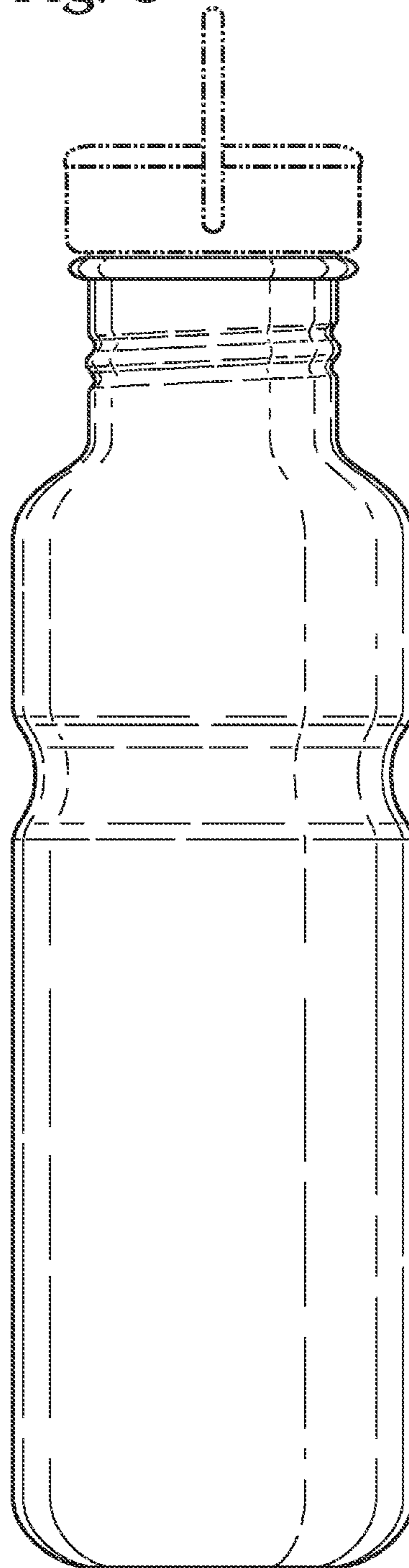



Fig. 6

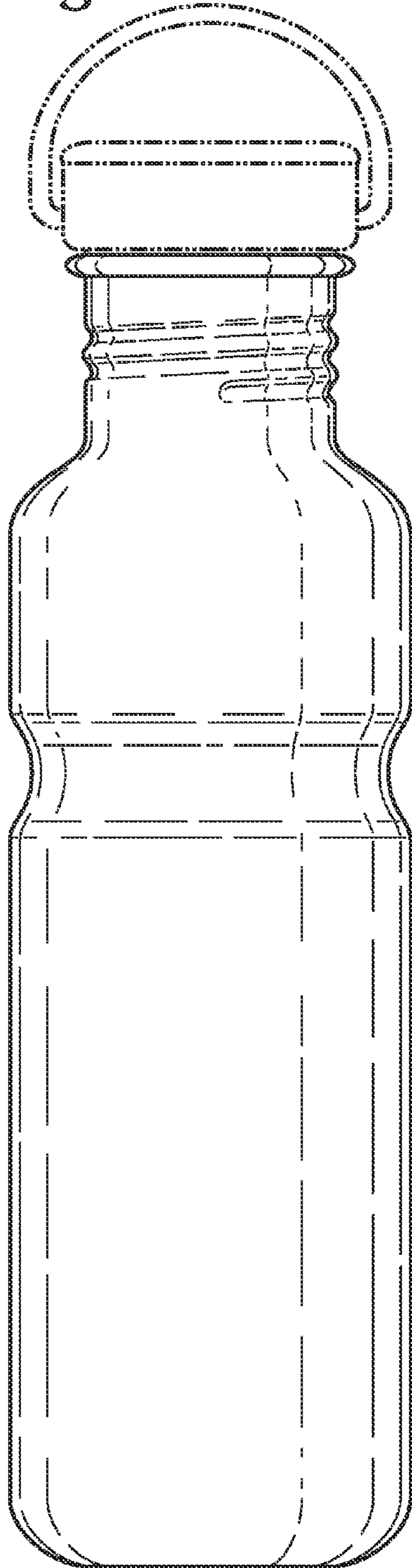

Fig. 7

