



US00D655530S

(12) **United States Design Patent**  
**Denby**

(10) **Patent No.:** **US D655,530 S**  
(45) **Date of Patent:** **\*\* Mar. 13, 2012**

- (54) **MERCHANDISE DISPLAY RACK**
- (75) Inventor: **Scott Denby**, Minneapolis, MN (US)
- (73) Assignee: **Target Brands, Inc.**, Minneapolis, MN (US)
- (\*\*) Term: **14 Years**
- (21) Appl. No.: **29/393,742**
- (22) Filed: **Jun. 8, 2011**
- (51) **LOC (9) Cl.** ..... **06-04**
- (52) **U.S. Cl.** ..... **D6/411**
- (58) **Field of Classification Search** ..... D6/411,  
D6/415, 332, 429, 449, 396, 397, 428, 416,  
D6/418, 462, 467, 455, 458, 410, 491, 495;  
211/47, 94.03, 200; 248/354.5, 165, 170,  
248/167, 188.06, 188.1; D34/17  
See application file for complete search history.

- D459,106 S \* 6/2002 Walter ..... D6/411
- D534,012 S 12/2006 Lee, Sr.
- D563,694 S 3/2008 Mitchell
- D592,420 S \* 5/2009 Nankervis ..... D6/411

\* cited by examiner

*Primary Examiner* — Philip S Hyder  
*Assistant Examiner* — Sydney Buffalow  
(74) *Attorney, Agent, or Firm* — Griffiths & Seaton PLLC

(57) **CLAIM**

The ornamental design for a merchandise display rack, as shown and described.

**DESCRIPTION**

FIG. 1 is a front, perspective view of a merchandise display rack showing our new design;  
FIG. 2 is a bottom, perspective view thereof;  
FIG. 3 is a front view thereof, the rear view being a mirror image of the front view;  
FIG. 4 is a left side view thereof;  
FIG. 5 is a right side view thereof;  
FIG. 6 is a top view thereof; and,  
FIG. 7 is a bottom view thereof.

The features shown in broken lines depict environmental subject matter only and form no part of the claimed design. The unshaded bottom surface depicted in FIGS. 2 and 7, which is bounded by broken lines illustrated in the figures, also is not part of the claimed design.

**1 Claim, 5 Drawing Sheets**

(56) **References Cited**

U.S. PATENT DOCUMENTS

- D186,517 S \* 11/1959 Francis ..... D6/411
- 2,957,669 A \* 10/1960 Berlin ..... 248/121
- 3,224,722 A \* 12/1965 Flick ..... 248/353
- D339,009 S \* 9/1993 Evenson ..... D6/411
- D358,506 S \* 5/1995 Lara ..... D6/411
- D414,053 S \* 9/1999 Ordelman ..... D6/416
- D448,201 S \* 9/2001 Walter ..... D6/411
- D458,770 S \* 6/2002 Walter ..... D6/411

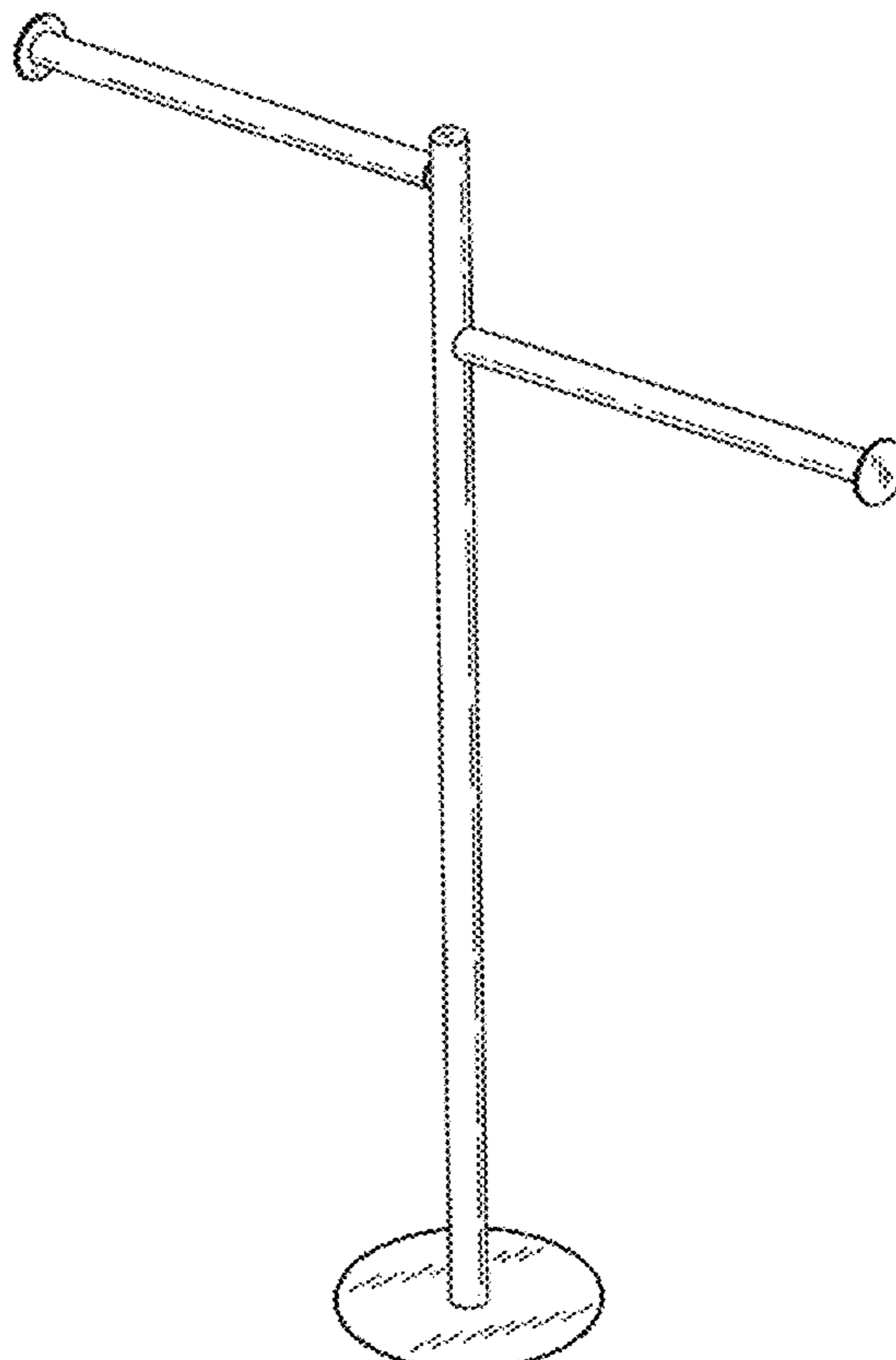

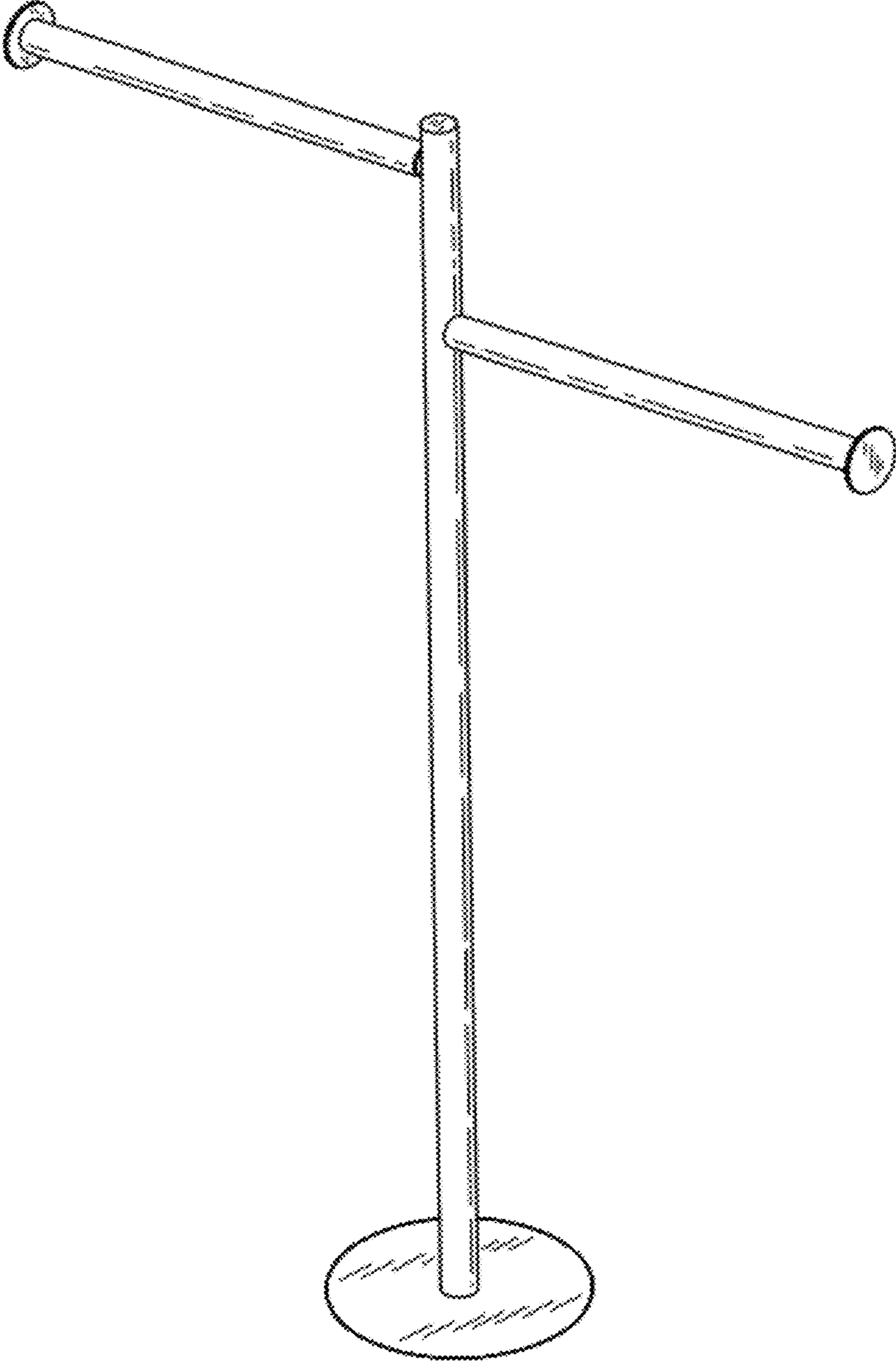

FIG. 1

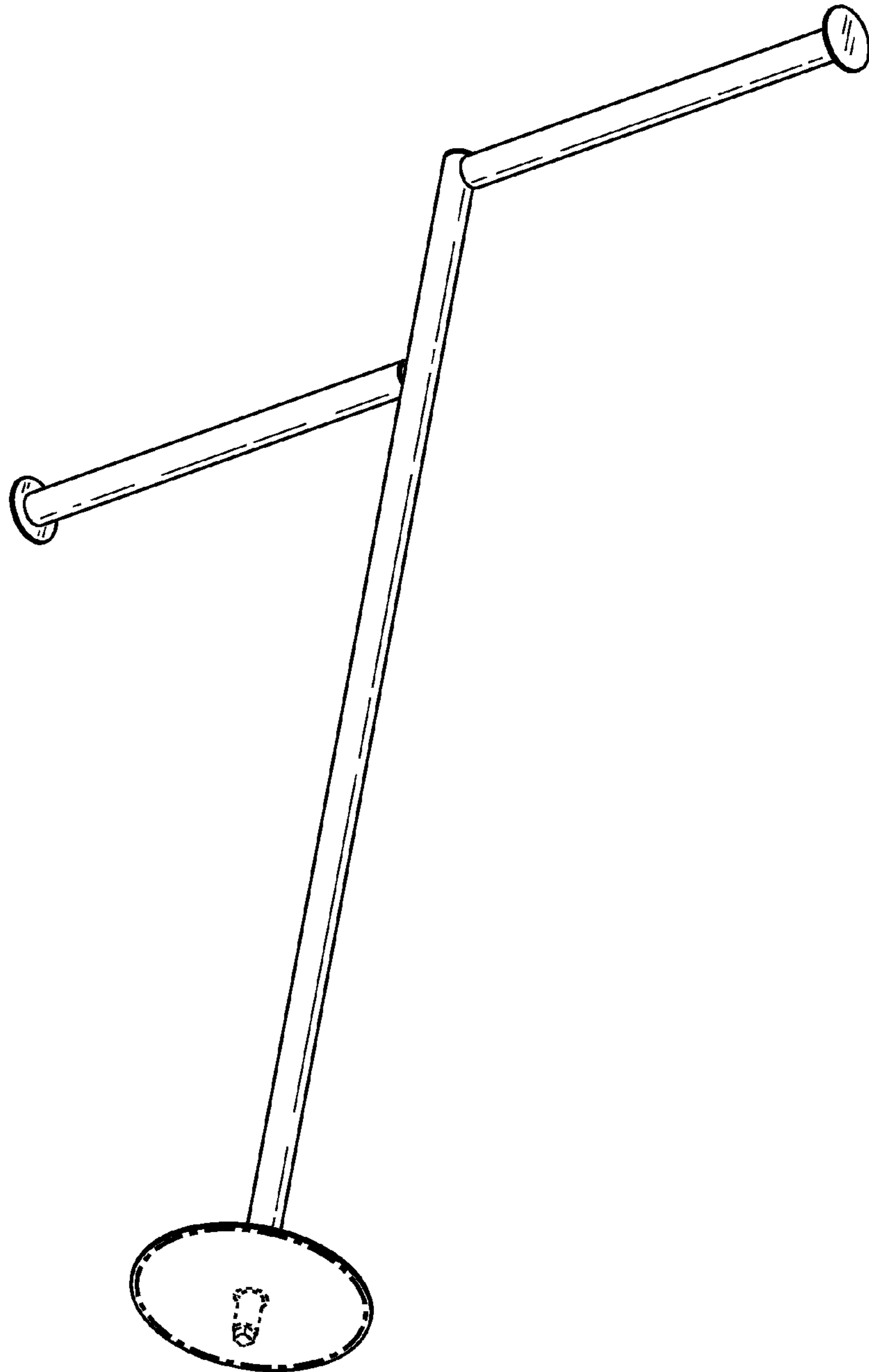

FIG. 2

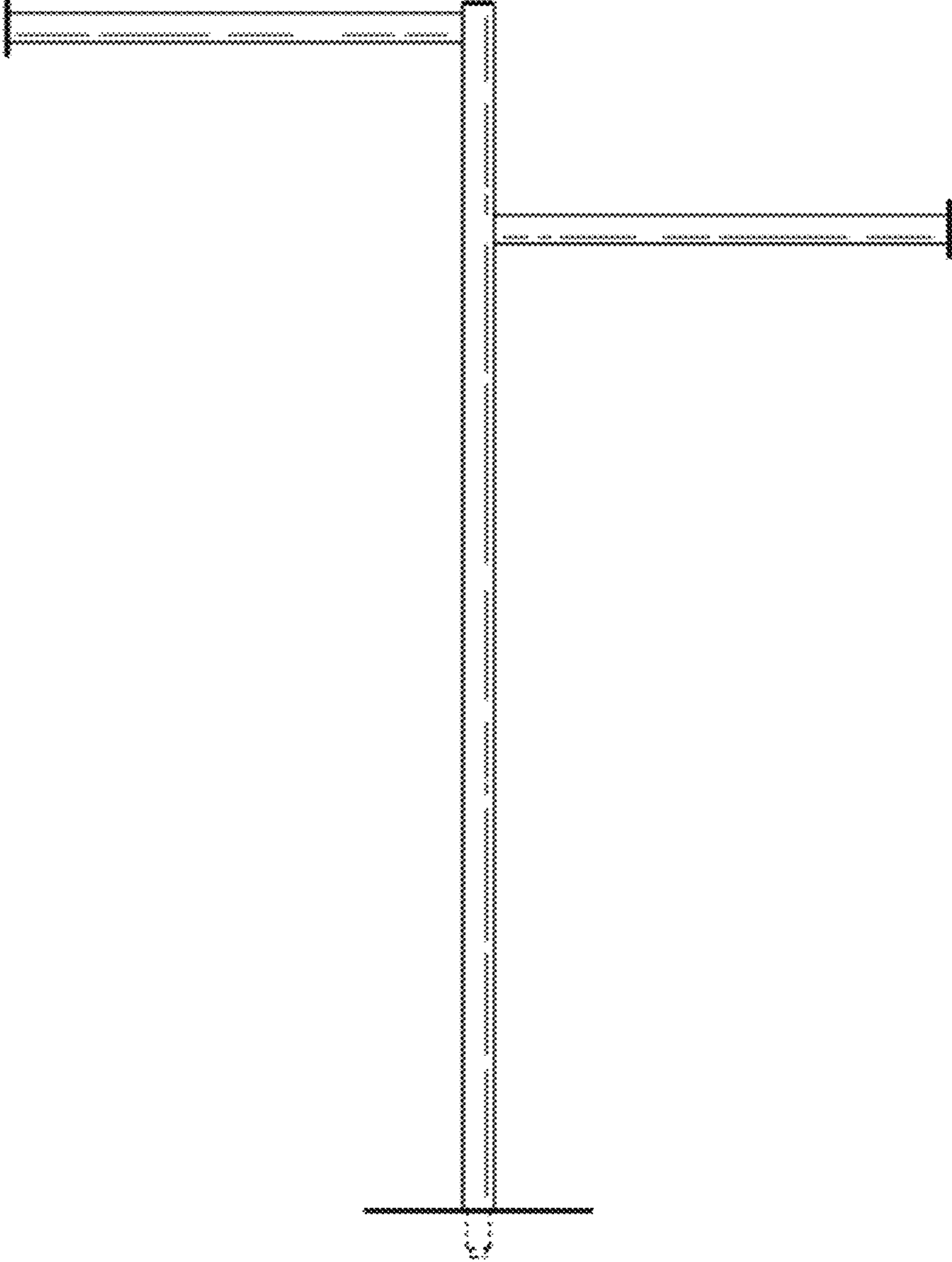

FIG. 3

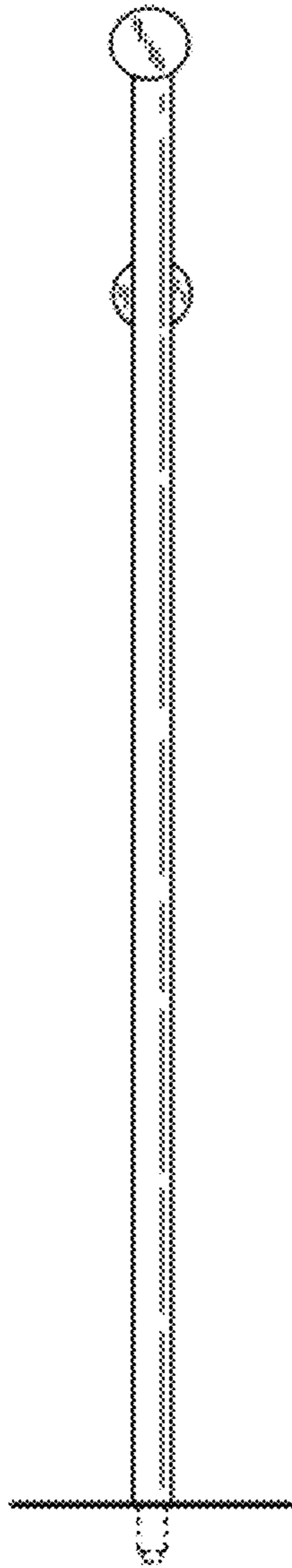

FIG. 4

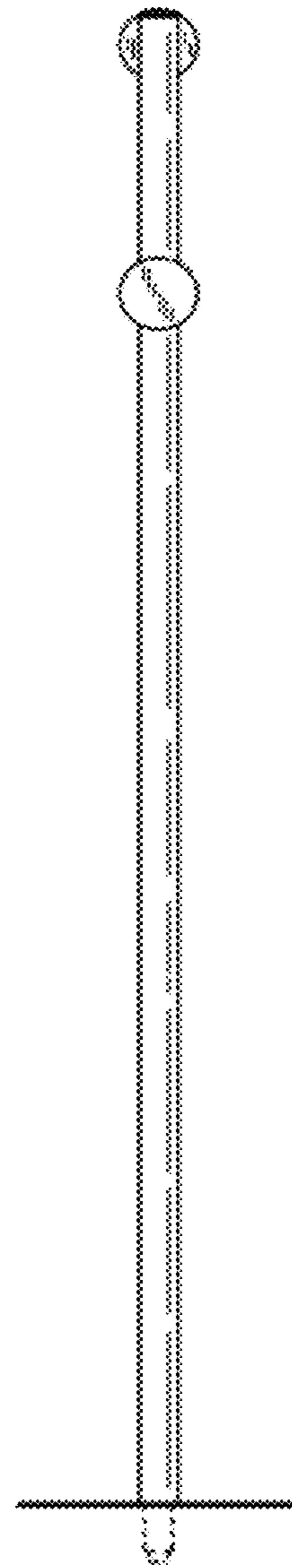

FIG. 5

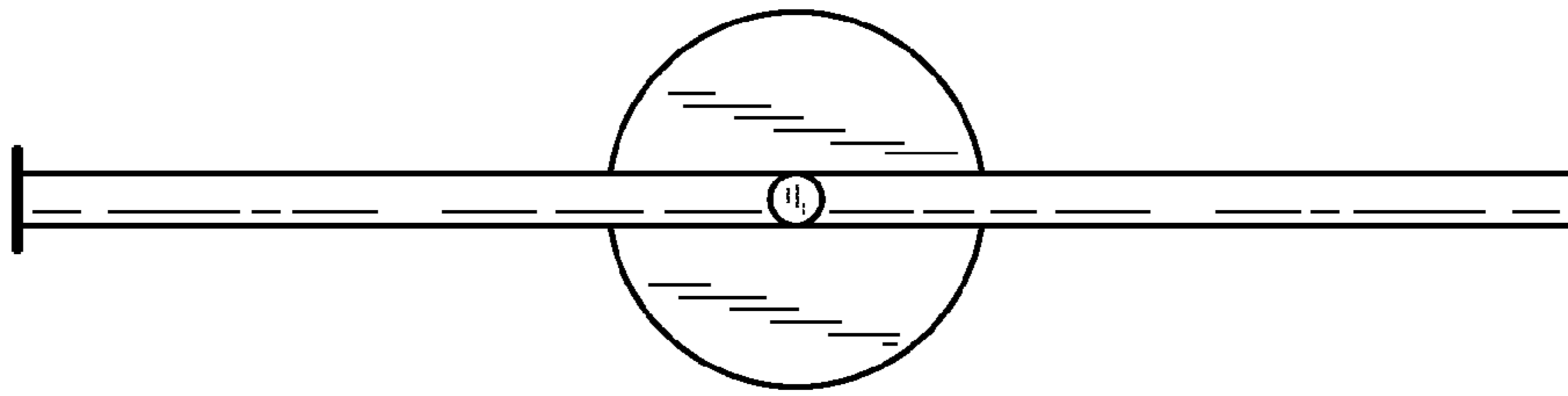

FIG. 6

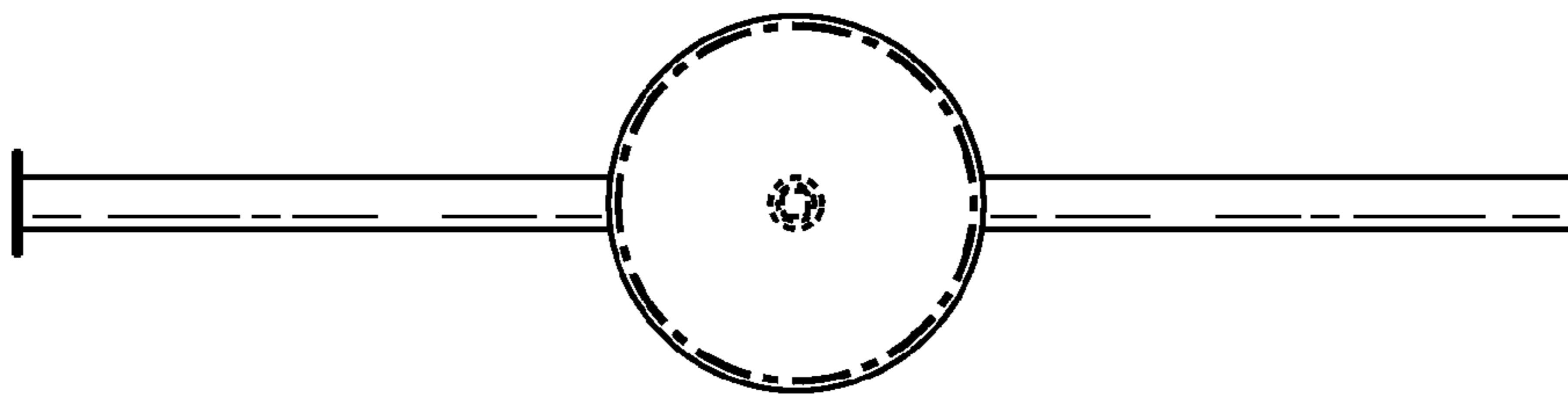

FIG. 7