



US00D655493S

(12) **United States Design Patent**  
**Kelley et al.**

(10) **Patent No.:** **US D655,493 S**  
(45) **Date of Patent:** **\*\* Mar. 13, 2012**

(54) **INTERCHANGEABLE FASTENER DEVICE  
AND DECORATION FOR SANDALS**

*Primary Examiner* — Dominic Simone  
(74) *Attorney, Agent, or Firm* — Clifford Kraft

(76) Inventors: **Sharyn P. Kelley**, Palm Harbor, FL  
(US); **Denis C. Kelley**, Palm Harbor, FL  
(US)

(57) **CLAIM**  
The ornamental design for an interchangeable fastener device  
and decoration for sandals, as shown and described.

(\*\*) Term: **14 Years**

**DESCRIPTION**

(21) Appl. No.: **29/363,669**

(22) Filed: **Jun. 11, 2010**

(51) **LOC (9) Cl.** ..... **02-99**

(52) **U.S. Cl.** ..... **D2/976; D2/946; D2/978**

(58) **Field of Classification Search** ..... D2/896,  
D2/902, 906–908, 943, 944, 946, 976, 978;  
36/45–49, 50.1, 77 M, 77 R, 83, 88, 113,  
36/114, 126–131, 136–139; D11/201, 218,  
D11/220, 229

See application file for complete search history.

FIGS. 1-6 show a first embodiment of the invention. FIGS. 7-9 show a second embodiment of the invention. FIG. 1 is a front-perspective view of the first embodiment of the present invention, showing environmental features. FIG. 2 is a front-perspective view of the first embodiment of the present invention, without environmental features. FIG. 3 is a top view thereof. The top and bottom are symmetrical. FIG. 4 is a side view thereof. The left and right sides are symmetrical. FIG. 5 is a front view thereof. The front and rear are symmetrical. FIG. 6 is the same as the view of FIG. 1 with the magnet shown removed. FIG. 7 is a side view of the second embodiment of the present invention. The left and right sides are symmetrical. FIG. 8 is a front view thereof. The front and rear are symmetrical; and, FIG. 9 is a top view thereof. The top and bottom are symmetrical. The portions shown in broken lines are for illustrative purposes only, and form no part of the claimed design.

(56) **References Cited**

**U.S. PATENT DOCUMENTS**

D20,461 S *	1/1891	Kraetzer	.....	D11/220
D25,117 S *	2/1896	Raymond	.....	D11/220
D25,819 S *	7/1896	Foster	.....	D11/220
D30,315 S *	3/1899	Richardson	.....	D11/220
D56,687 S *	11/1920	Baum	.....	D11/220
3,100,608 A *	8/1963	Goldfarb	.....	D11/201
3,156,962 A *	11/1964	Henson	.....	D11/220
D477,246 S *	7/2003	Takeda	.....	D11/220
D539,698 S *	4/2007	Choi	.....	D11/220
D579,194 S *	10/2008	Caylor	.....	D2/976

\* cited by examiner

**1 Claim, 7 Drawing Sheets**

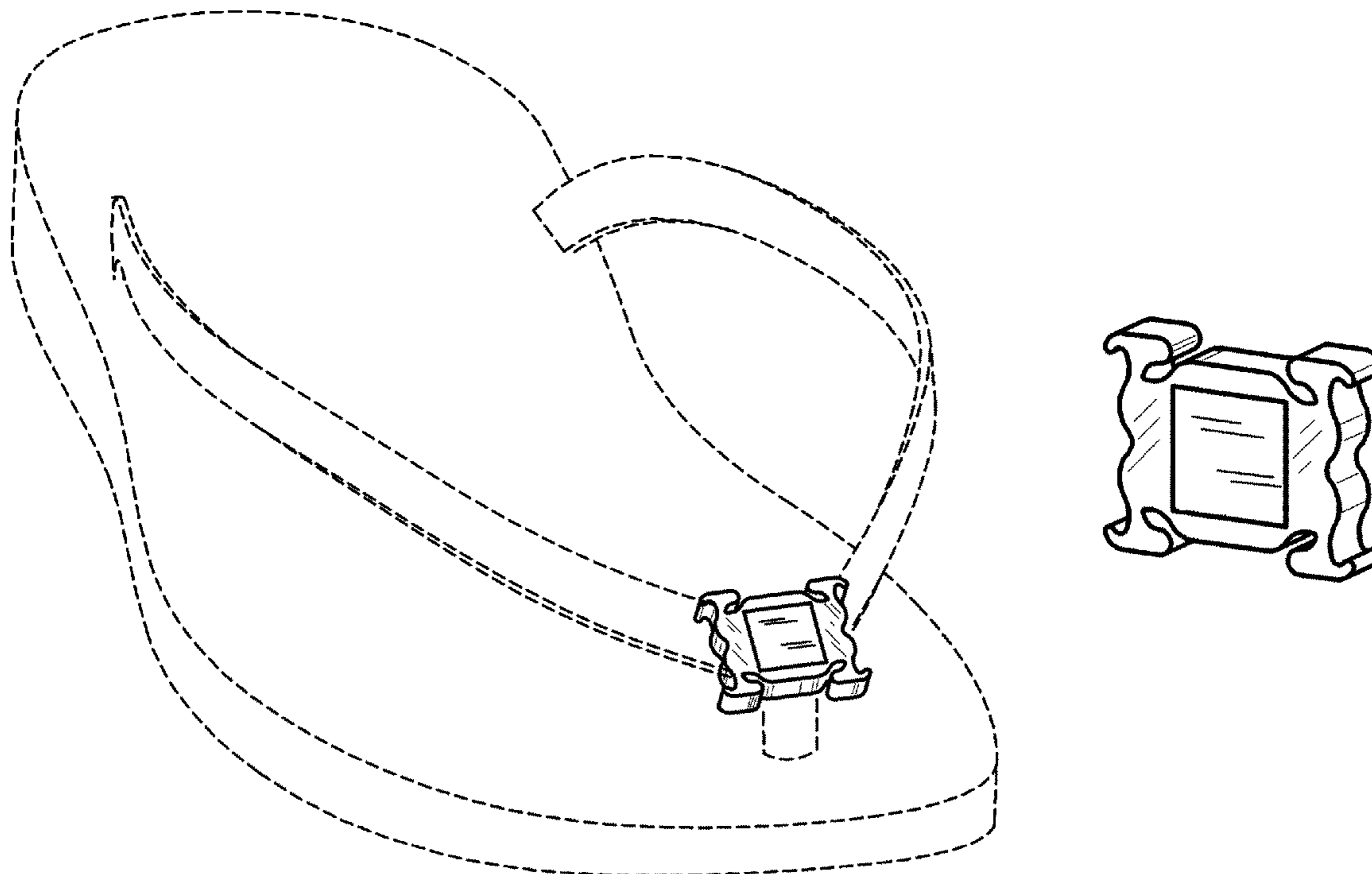

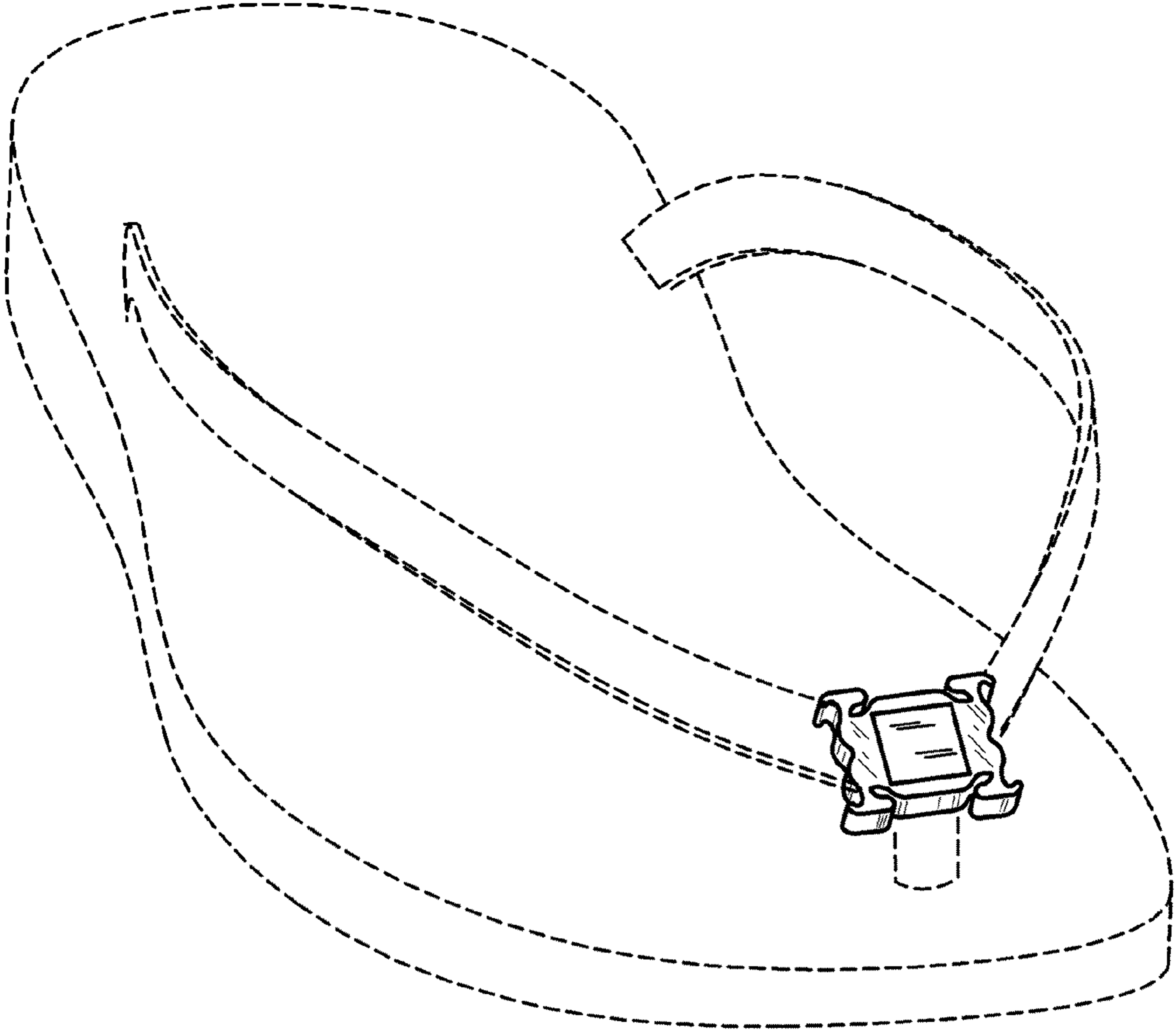

Figure 1

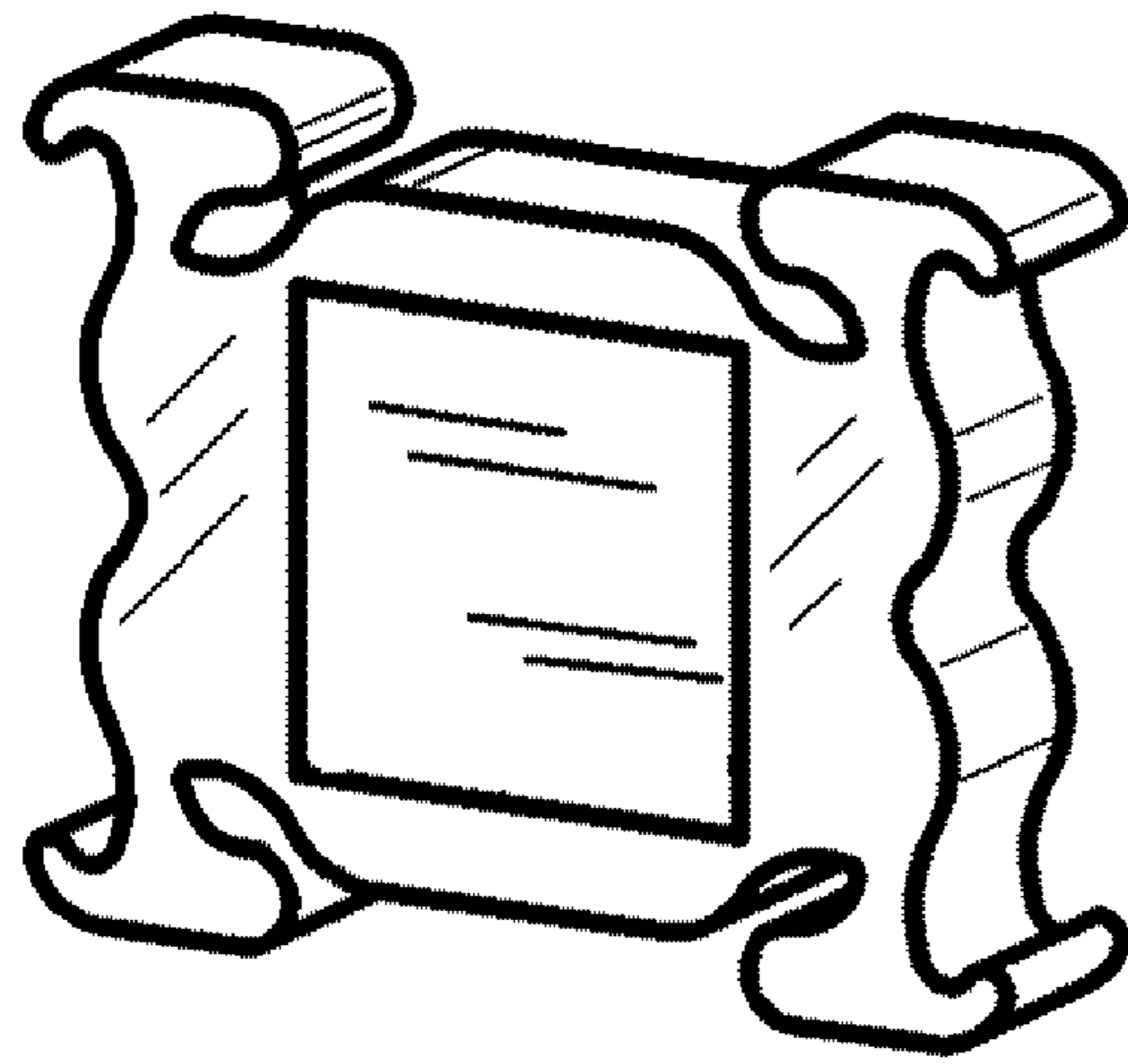

Figure 2



Figure 3

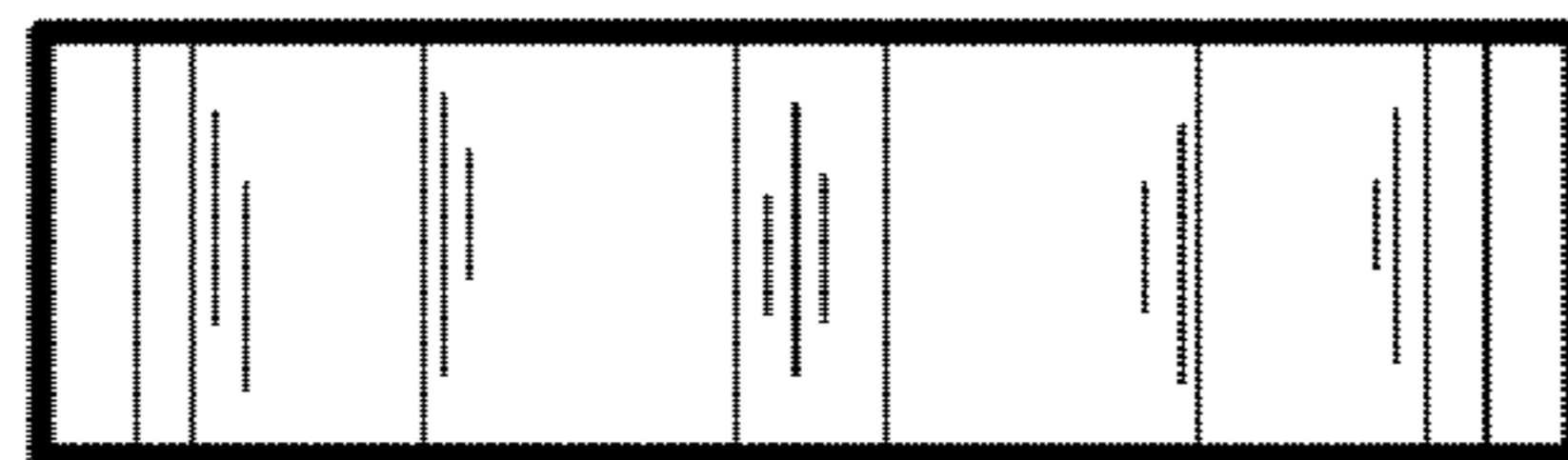

Figure 4

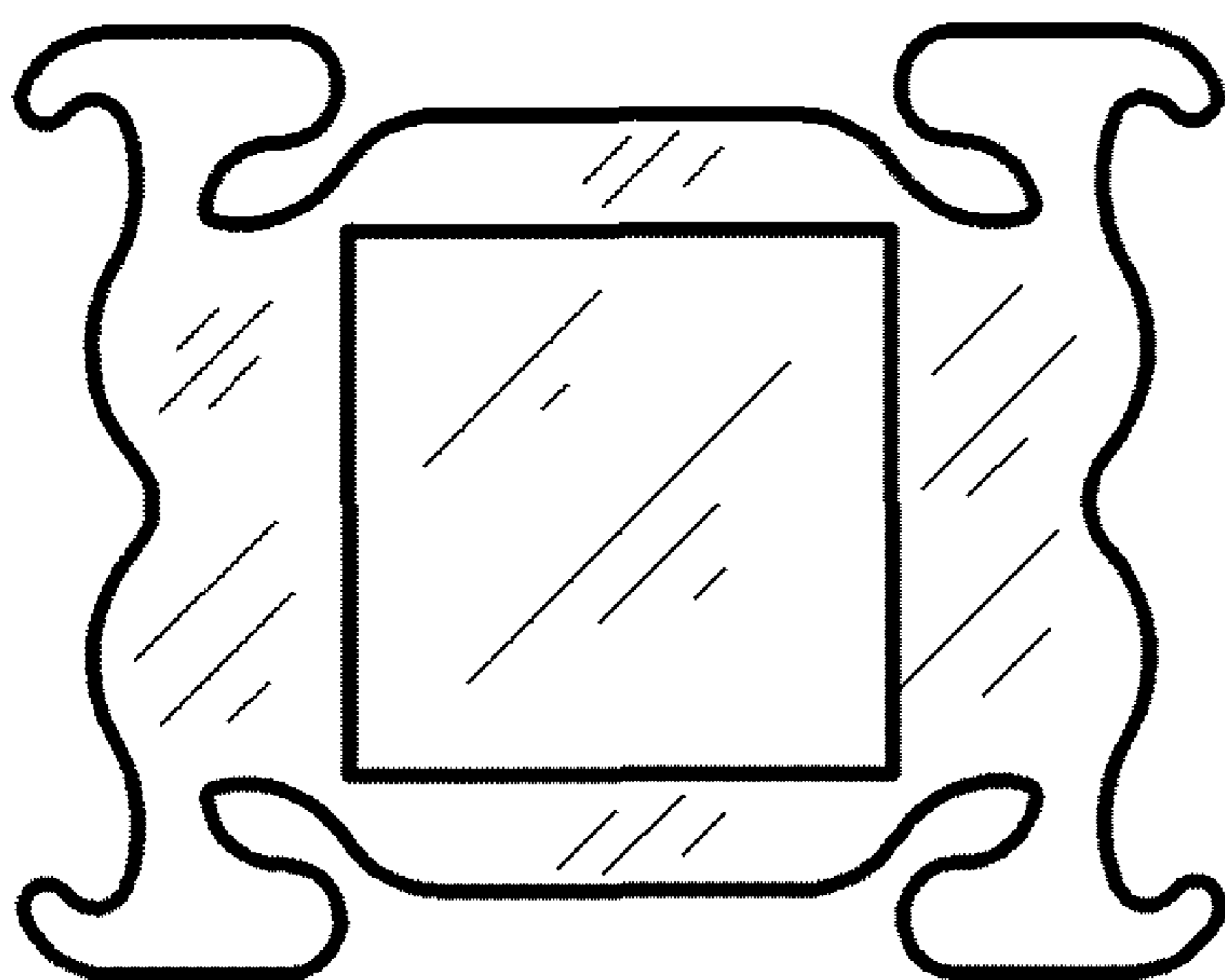

Figure 5

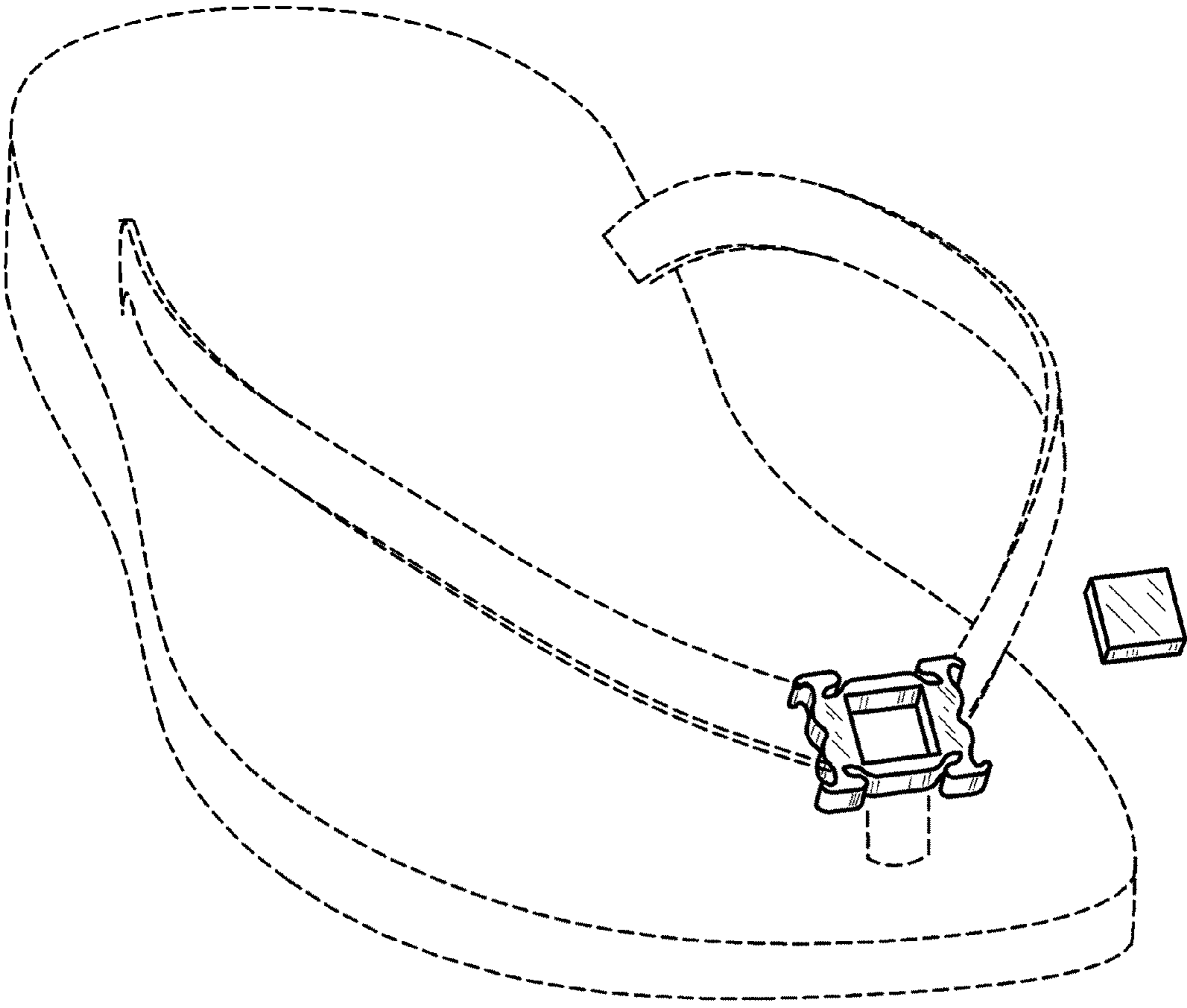

Figure 6

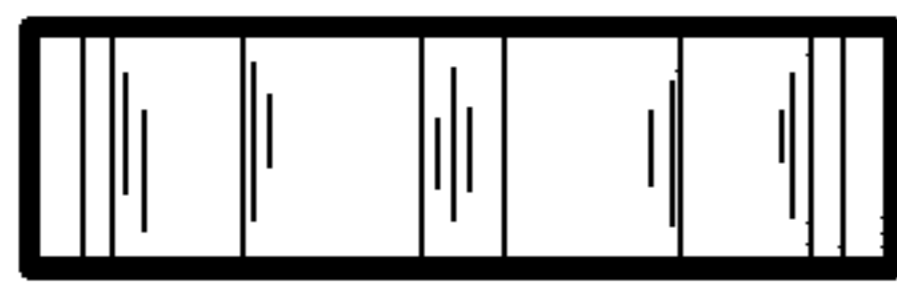

Figure 7

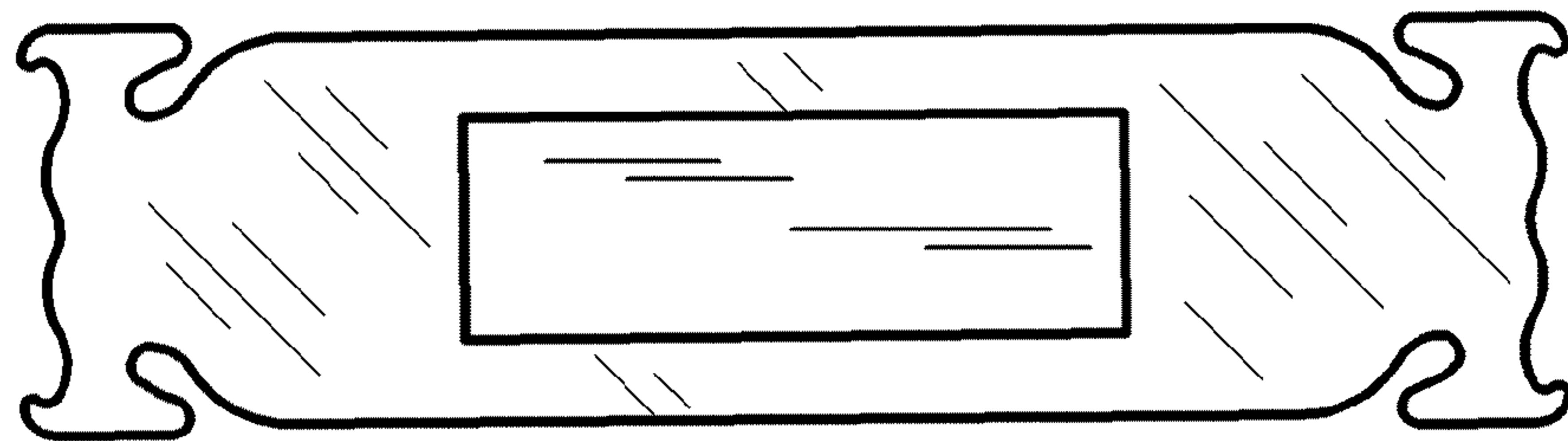

Figure 8

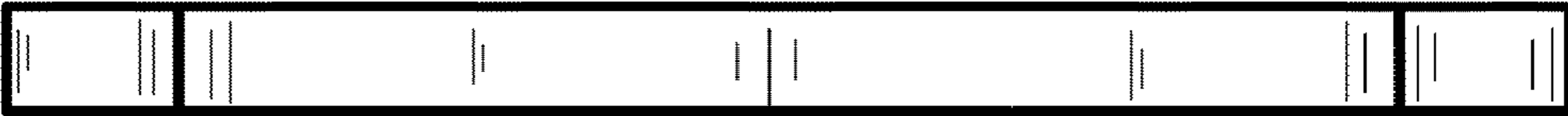

Figure 9