



US00D655402S

(12) **United States Design Patent**
Osorio

(10) **Patent No.:** **US D655,402 S**
(45) **Date of Patent:** **** Mar. 6, 2012**

(54) **VAPORIZER**

(76) Inventor: **Roman Osorio**, Mountain View, CA
(US)

(**) Term: **14 Years**

(21) Appl. No.: **29/397,682**

(22) Filed: **Jul. 19, 2011**

(51) **LOC (9) Cl.** **23-04**

(52) **U.S. Cl.** **D23/360**

(58) **Field of Classification Search** D23/355-366,
D23/352, 369, 332, 333, 335, 336, 342, 351;
422/120, 122; 55/356, 473, 504; 96/97;
D14/188, 170, 172; 261/DIG. 17, DIG. 65,
261/DIG. 88, DIG. 31; D18/34.6

See application file for complete search history.

(56) **References Cited**

U.S. PATENT DOCUMENTS

D428,646 S * 7/2000 Bunce et al. D23/366
D430,279 S * 8/2000 Bunce et al. D23/366
D453,373 S * 2/2002 Drake et al. D23/366

D462,431 S * 9/2002 Bunce et al. D23/366
D509,578 S * 9/2005 Yao D23/364
D527,086 S * 8/2006 Russak et al. D23/364
D544,084 S * 6/2007 Michaels et al. D23/366
D560,788 S * 1/2008 Farrell et al. D23/366
D574,072 S * 7/2008 Carlson et al. D23/364
D582,534 S * 12/2008 Conway et al. D23/366
D593,669 S * 6/2009 Daelemans et al. D23/366
D599,899 S * 9/2009 Thompson D23/366
D633,191 S * 2/2011 Sato D23/366

* cited by examiner

Primary Examiner — David Muller

(57) **CLAIM**

The ornamental design for a vaporizer, as shown and described.

DESCRIPTION

FIG. 1 is a perspective view of the present invention;
FIG. 2 is a frontal view of the present invention;
FIG. 3 is a top view of the present invention;
FIG. 4 is a left side view of the present invention;
FIG. 5 is a right side view of the present invention; and,
FIG. 6 is a rear view of the present invention.

1 Claim, 3 Drawing Sheets

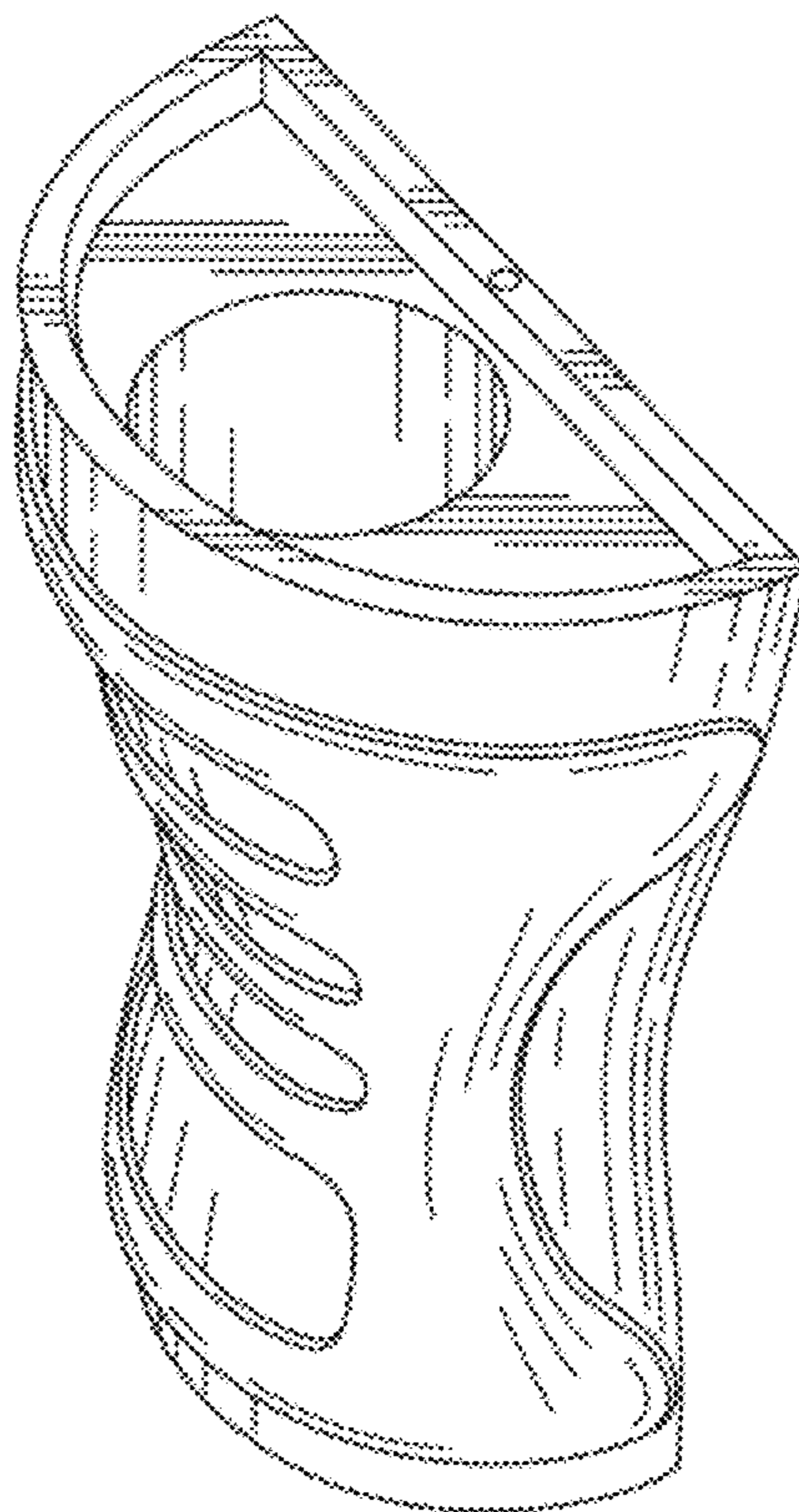

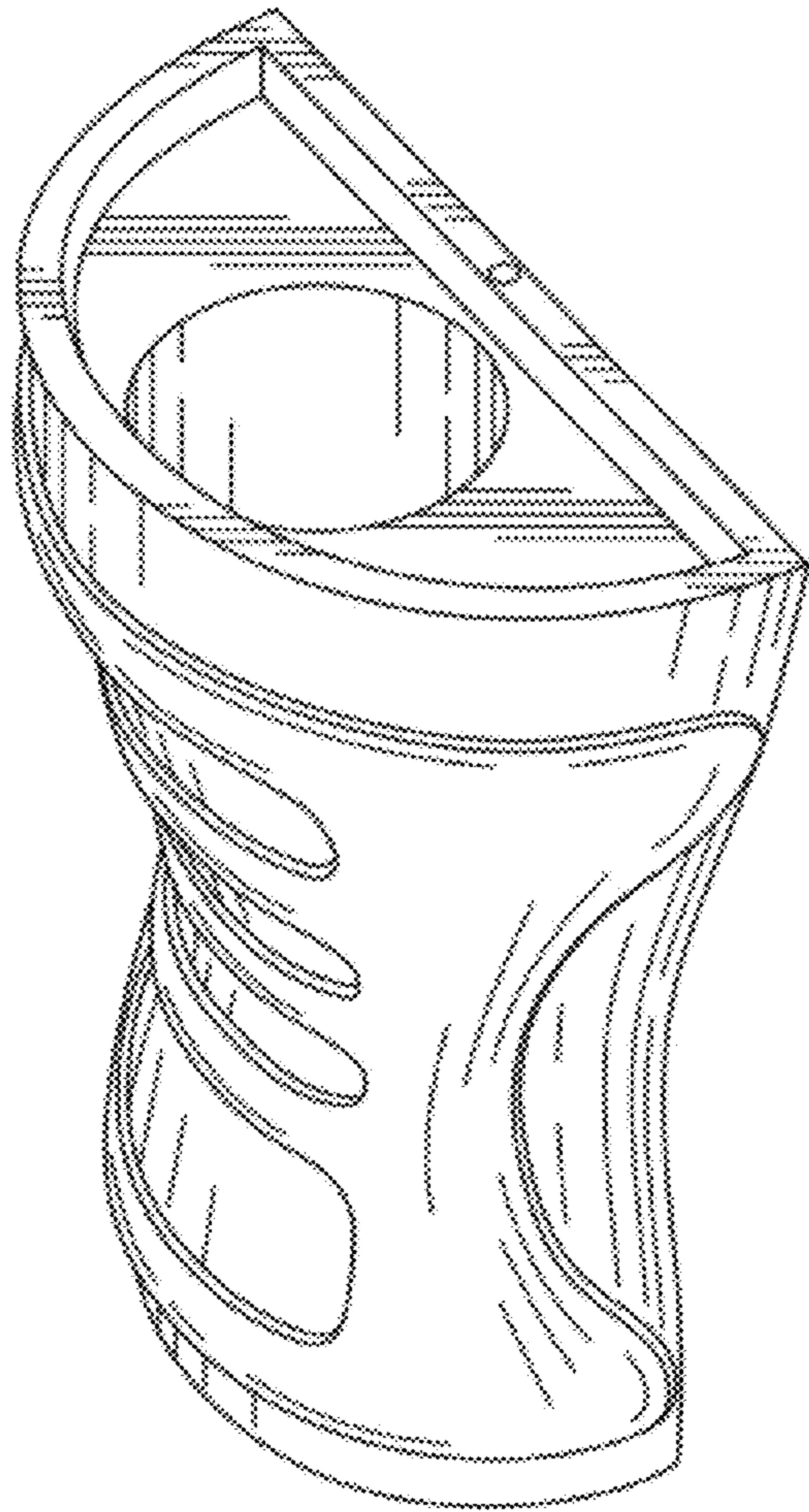

FIG. 1

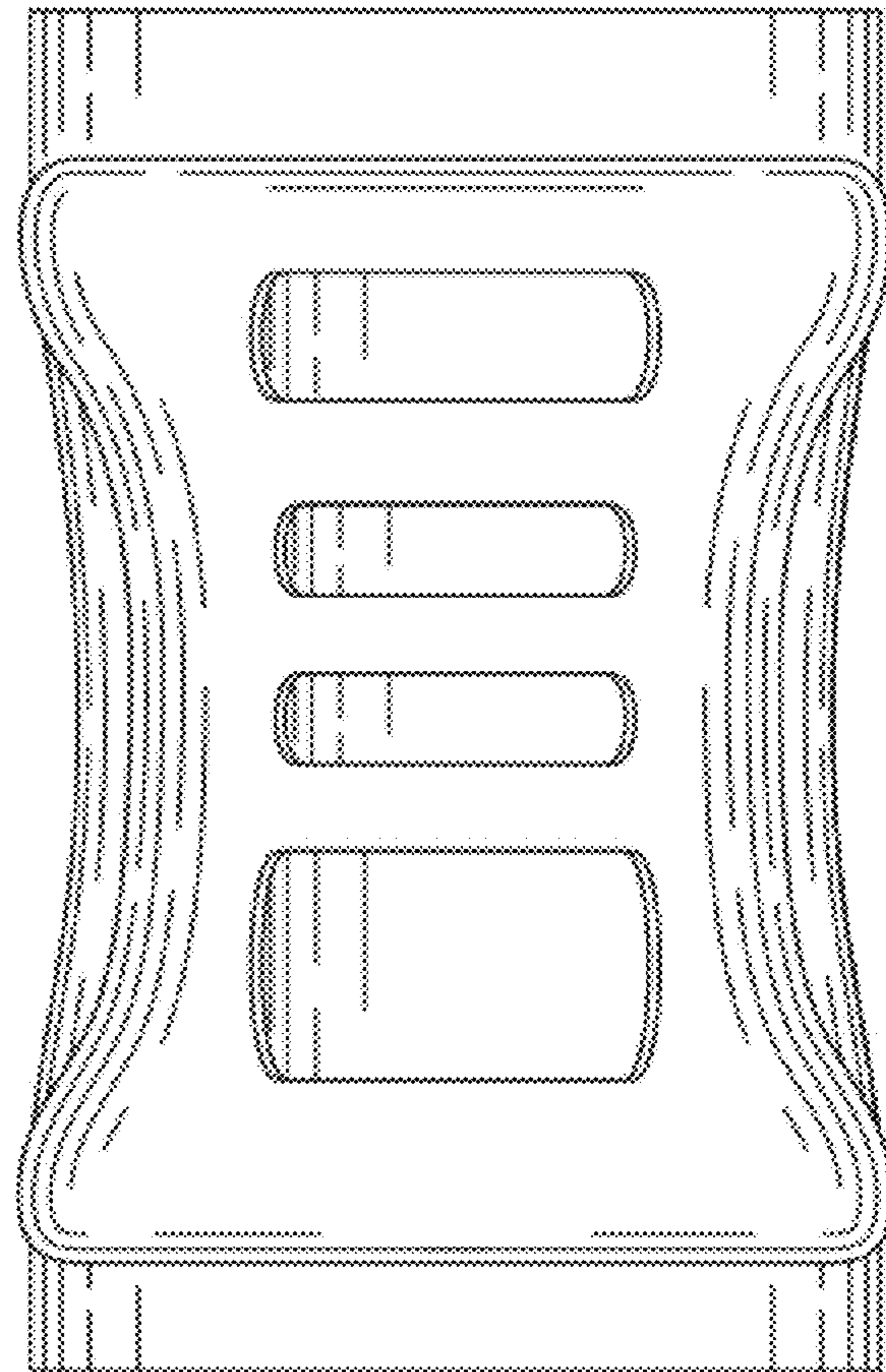

FIG. 2

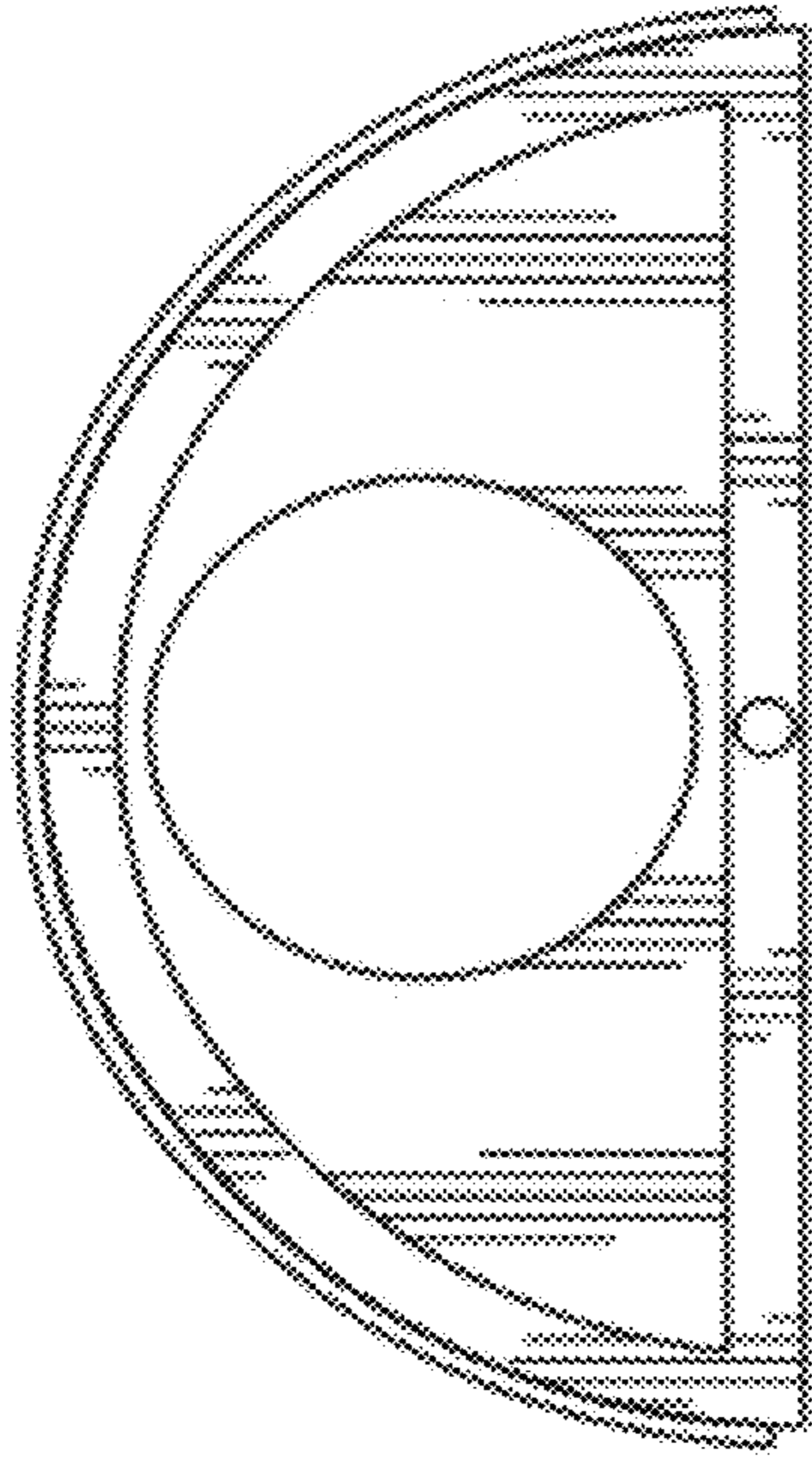

FIG. 3

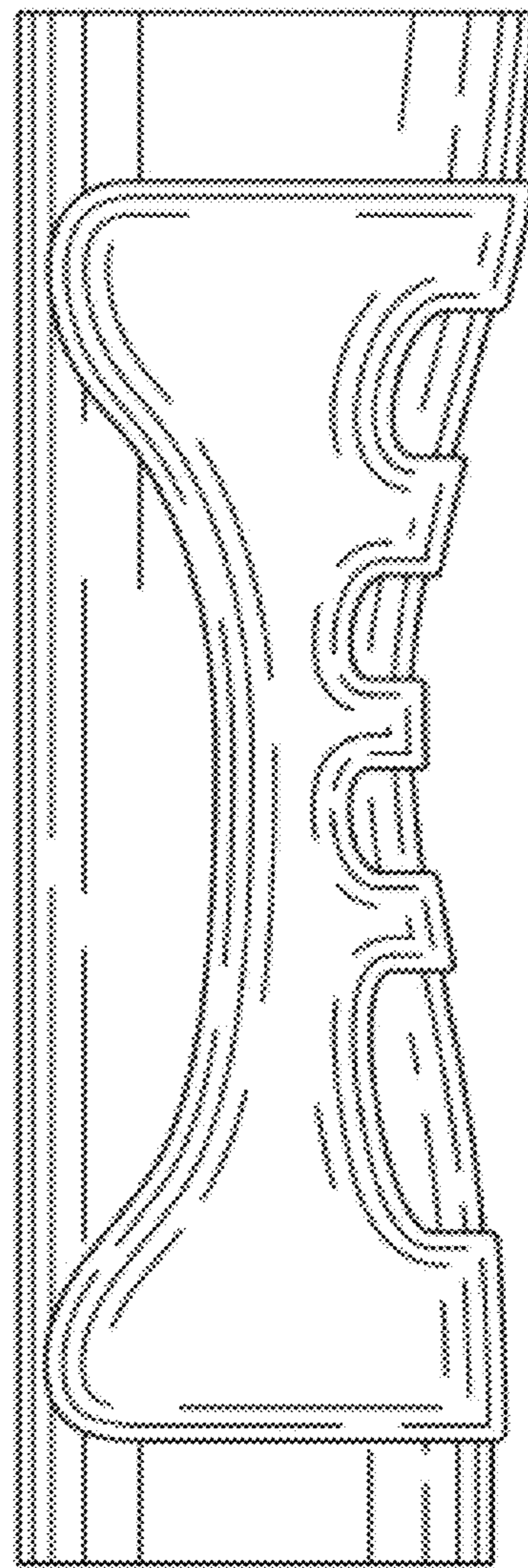

FIG. 4

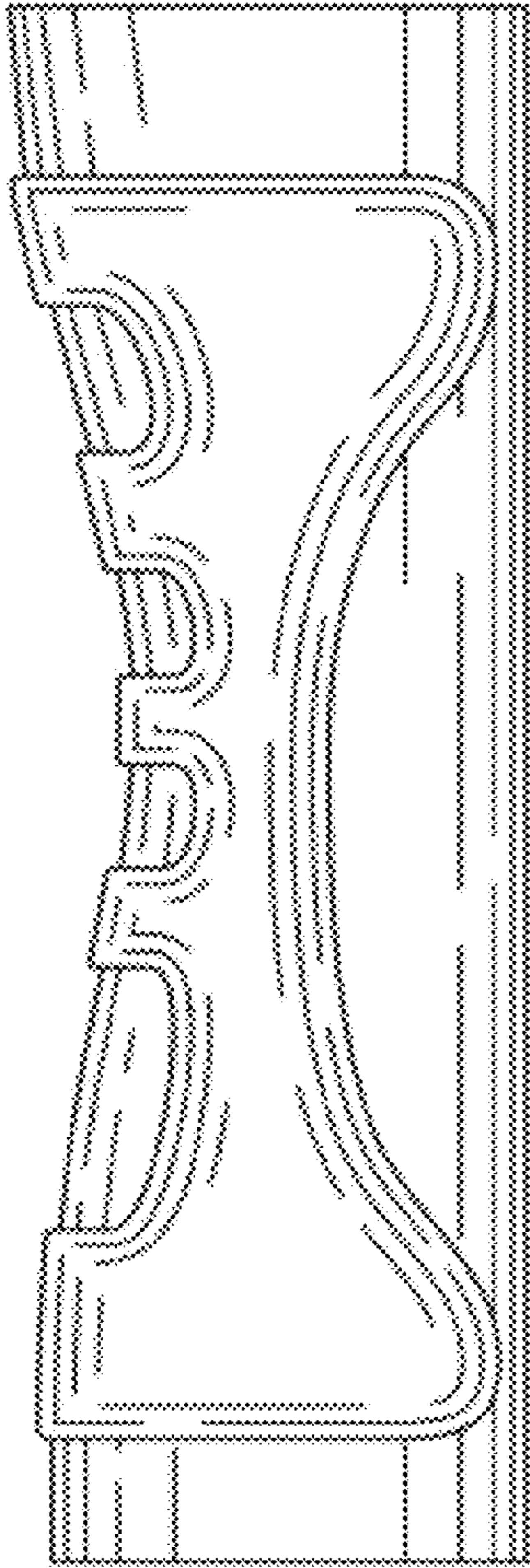

FIG. 5

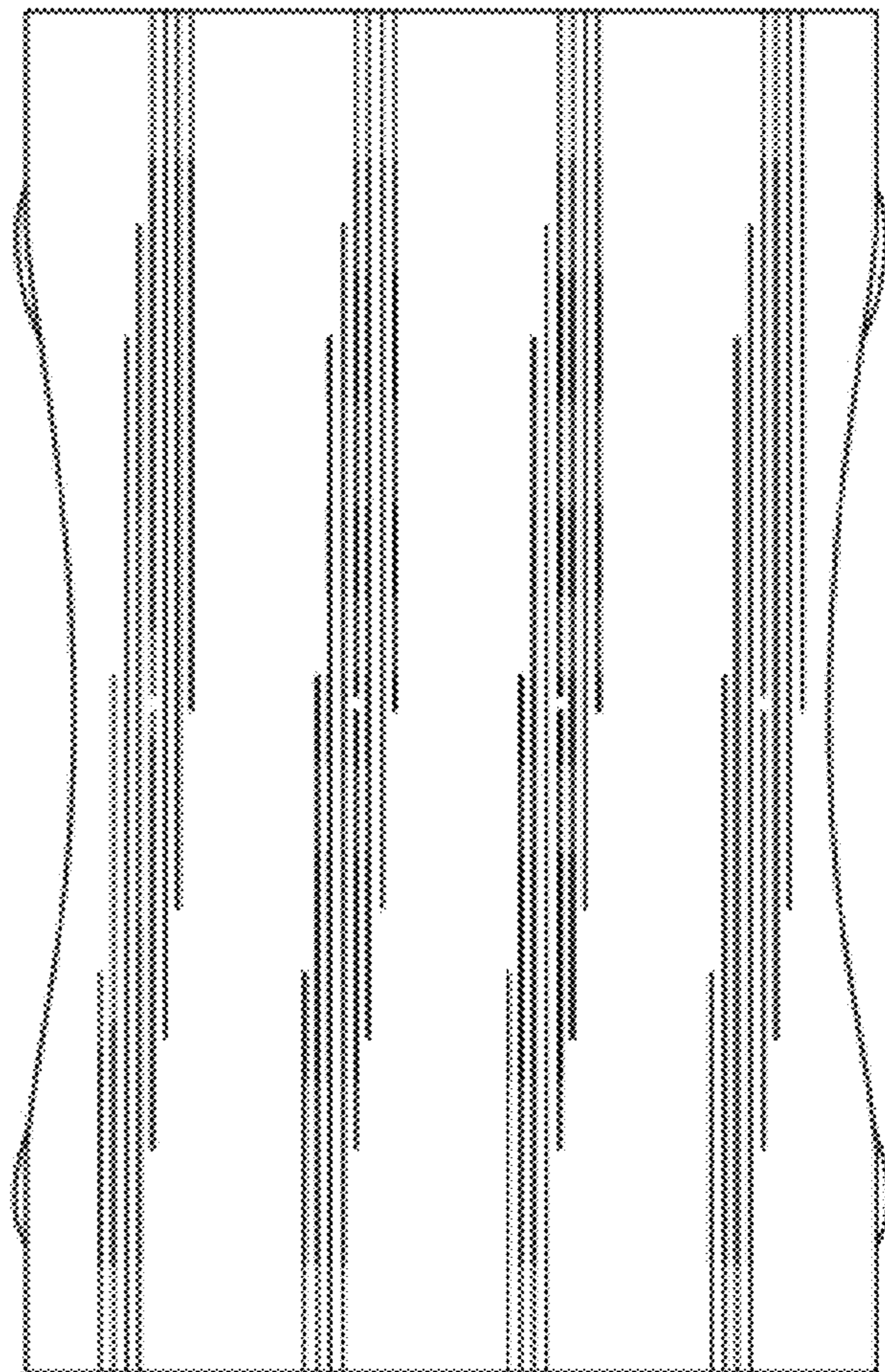

FIG. 6