



US00D655382S

(12) **United States Design Patent**  
**Flowers et al.**

(10) **Patent No.:** **US D655,382 S**  
(45) **Date of Patent:** **\*\* Mar. 6, 2012**

(54) **HANDHELD SHOWER SPRAY**

(75) Inventors: **Paul Flowers**, Duesseldorf (DE);  
**Patrick Speck**, Duesseldorf (DE)

(73) Assignee: **Grohe AG**, Hemer (DE)

(\*\*) Term: **14 Years**

(21) Appl. No.: **29/391,001**

(22) Filed: **May 2, 2011**

(30) **Foreign Application Priority Data**

Nov. 4, 2010 (EM) ..... 001777053-0001  
Nov. 4, 2010 (EM) ..... 001777053-0002  
Nov. 4, 2010 (EM) ..... 001777053-0003

(51) **LOC (9) Cl.** ..... **23-01**

(52) **U.S. Cl.** ..... **D23/223**

(58) **Field of Classification Search** ..... D23/213,  
D23/223, 226, 229, 230; 239/462, 394, 282,  
239/283

See application file for complete search history.

(56) **References Cited**

**U.S. PATENT DOCUMENTS**

D424,161 S \* 5/2000 Haug et al. .... D23/223  
D581,484 S \* 11/2008 Schoenherr et al. .... D23/223  
D610,228 S \* 2/2010 Wu et al. .... D23/223  
D617,419 S \* 6/2010 Lee ..... D23/223  
D619,214 S \* 7/2010 Lee ..... D23/223

\* cited by examiner

*Primary Examiner* — Robin V Webster

(74) *Attorney, Agent, or Firm* — Muncy, Geissler, Olds &  
Lowe, PLLC

(57) **CLAIM**

The ornamental design for a handheld shower spray, as shown and described.

**DESCRIPTION**

FIG. 1 is a left side elevational view of a handheld shower spray according to a first embodiment of the present invention.

FIG. 2 is a right side elevational view of the handheld shower spray of FIG. 1.

FIG. 3 is a front elevational view of the handheld shower spray of FIG. 1.

FIG. 4 is a rear elevational view of the handheld shower spray of FIG. 1.

FIG. 5 is a top plan view of the handheld shower spray of FIG. 1.

FIG. 6 is a bottom plan view of the handheld shower spray of FIG. 1.

FIG. 7 is a three quarter view of the handheld shower spray of FIG. 1.

FIG. 8 is a left side elevational view of a handheld shower spray according to a second embodiment of the present invention.

FIG. 9 is a right side elevational view of the handheld shower spray of FIG. 8.

FIG. 10 is a front elevational view of the handheld shower spray of FIG. 8.

FIG. 11 is a rear elevational view of the handheld shower spray of FIG. 8.

FIG. 12 is a top plan view of the handheld shower spray of FIG. 8.

FIG. 13 is a bottom plan view of the handheld shower spray of FIG. 8; and,

FIG. 14 is a three quarter view of the handheld shower spray of FIG. 8.

The dashed lines illustrate environment that does not form a part of the present invention, and no claim is made to the material illustrated with dashed lines.

**1 Claim, 8 Drawing Sheets**

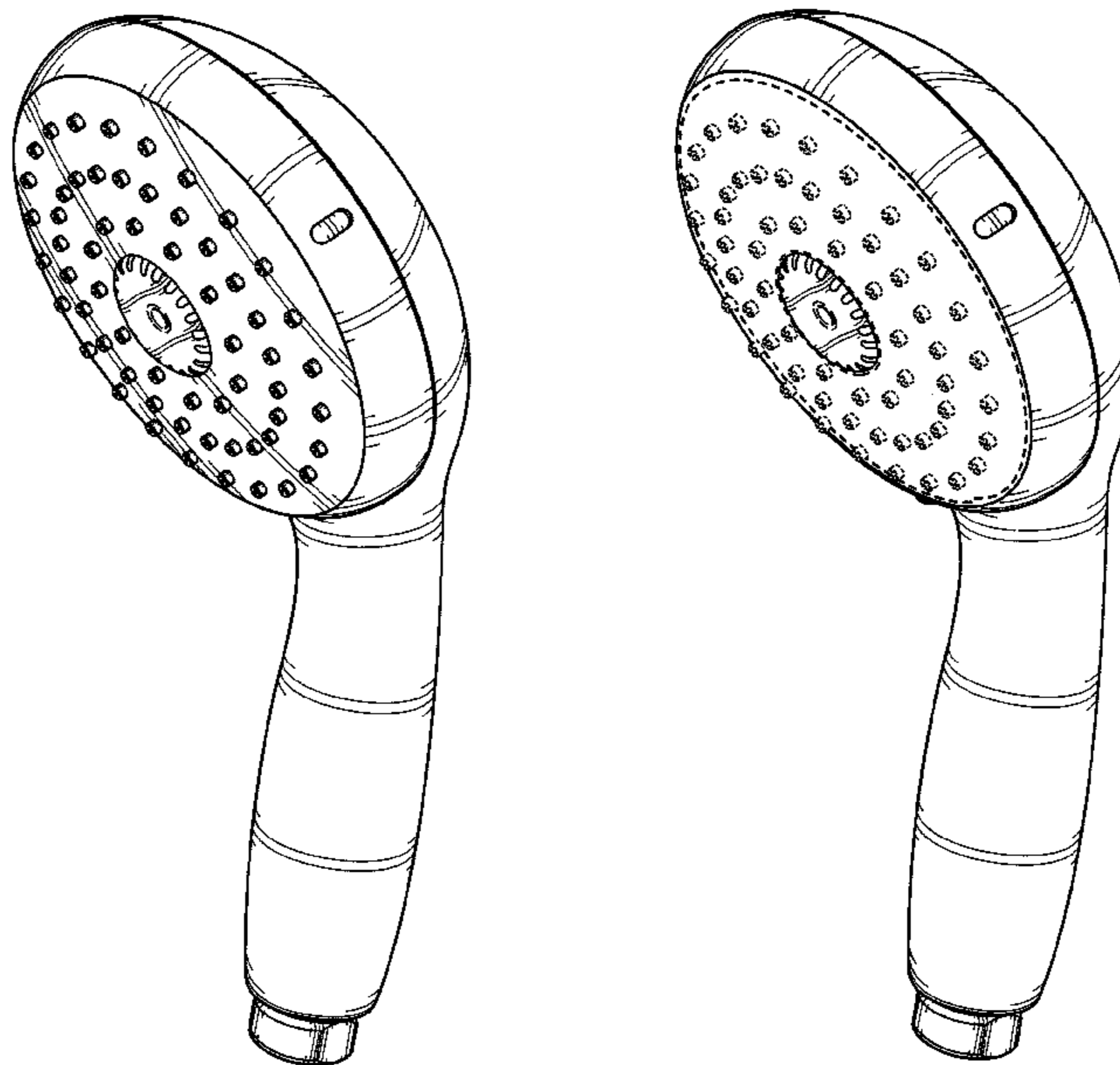

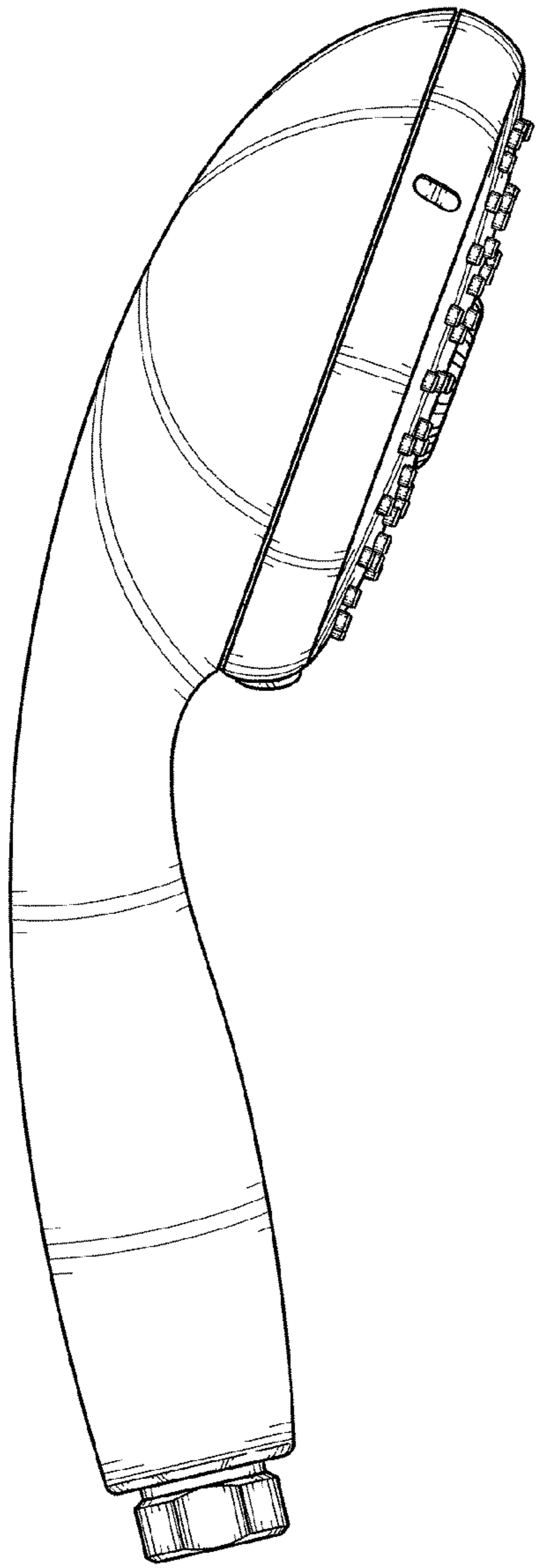

FIG. 1

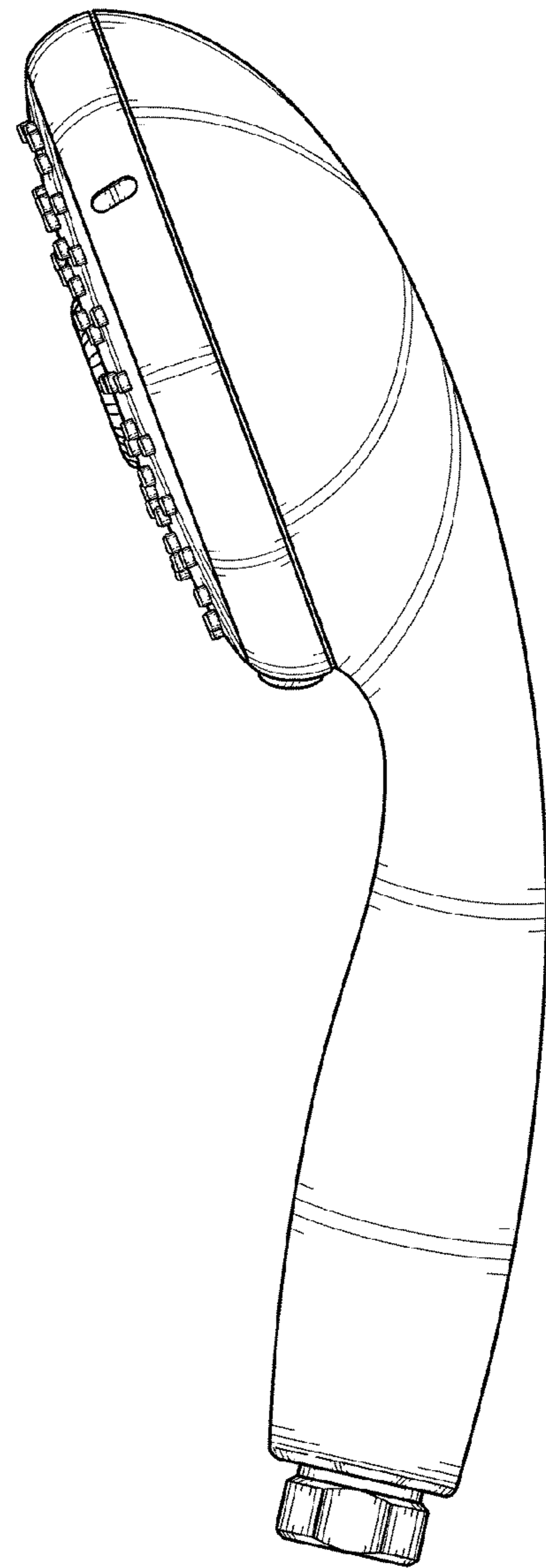

FIG. 2

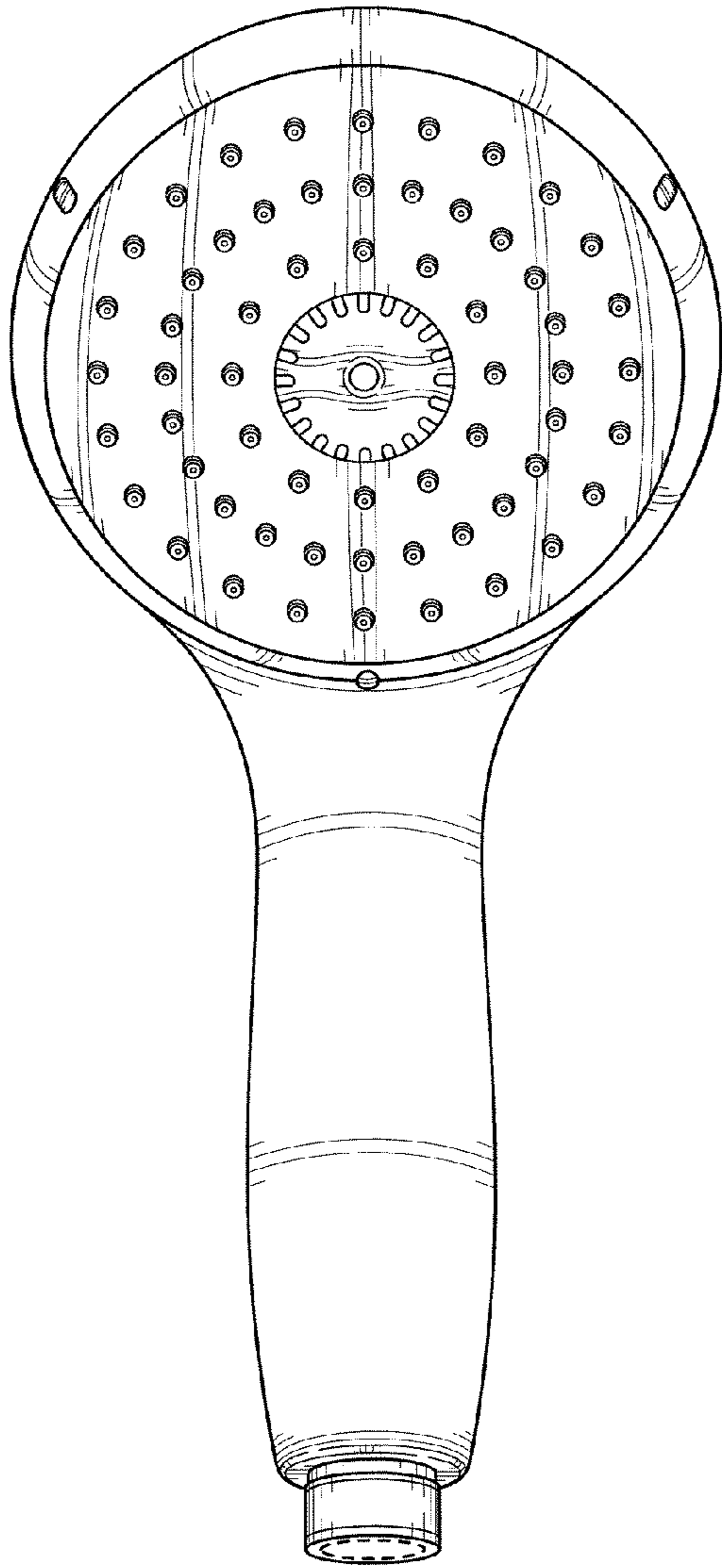

FIG. 3

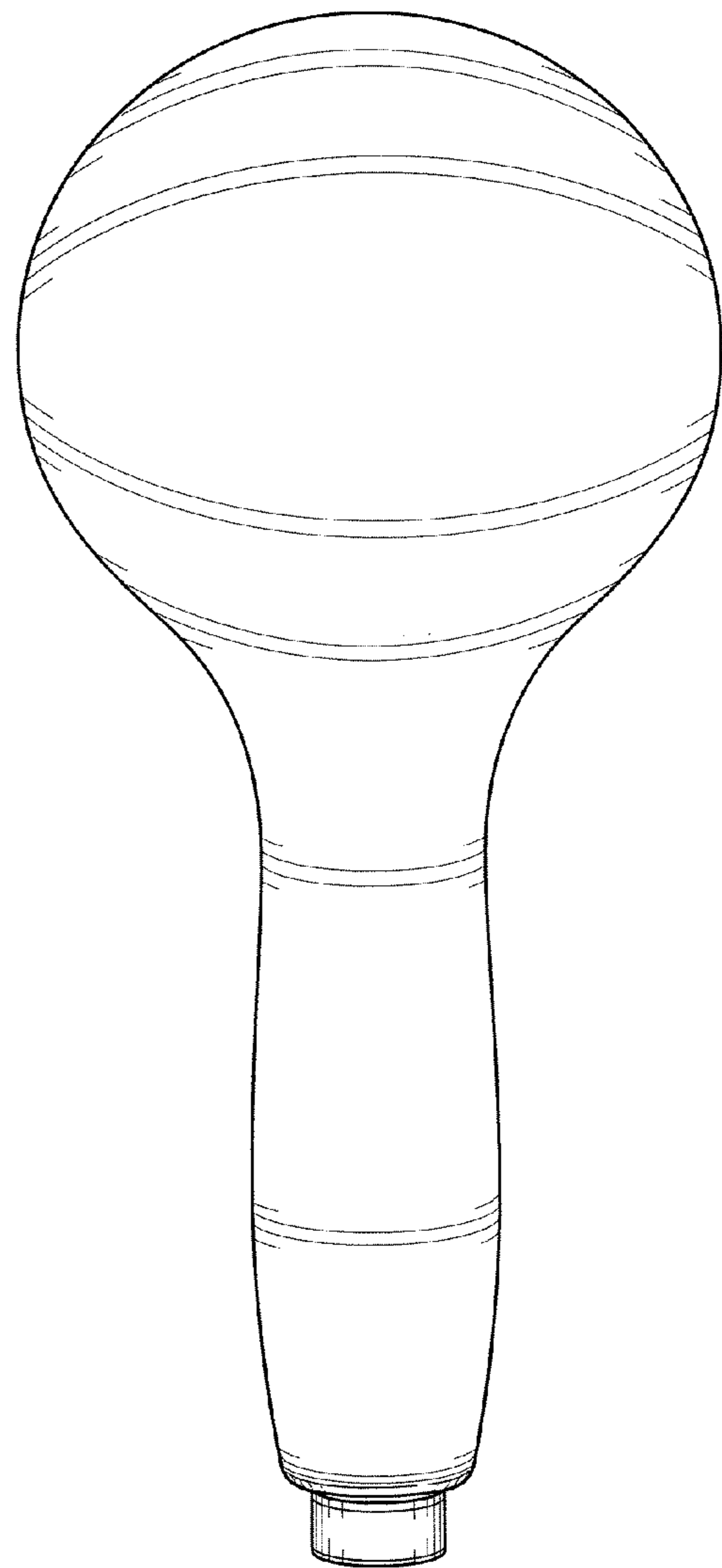

FIG. 4

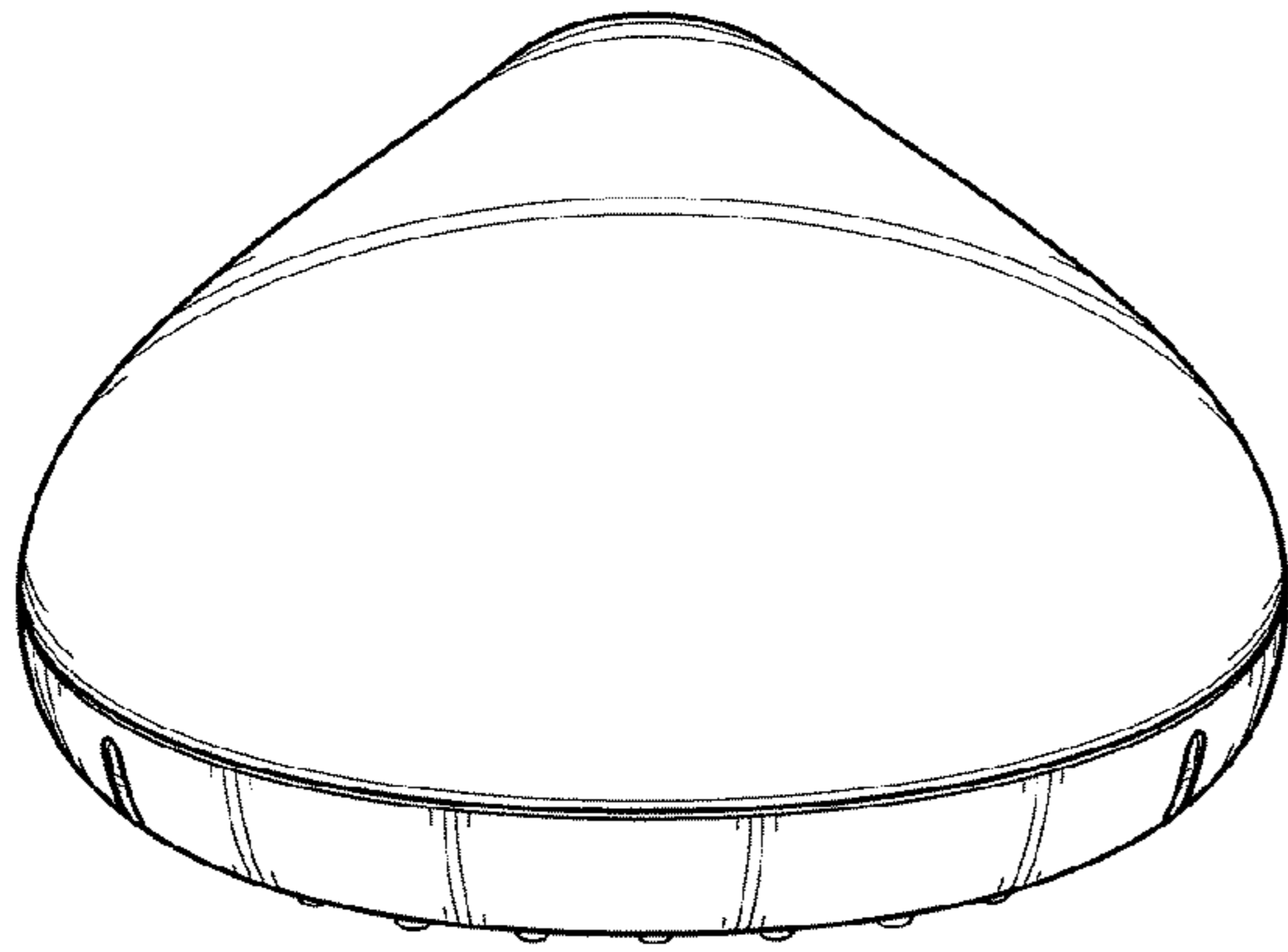

FIG. 5

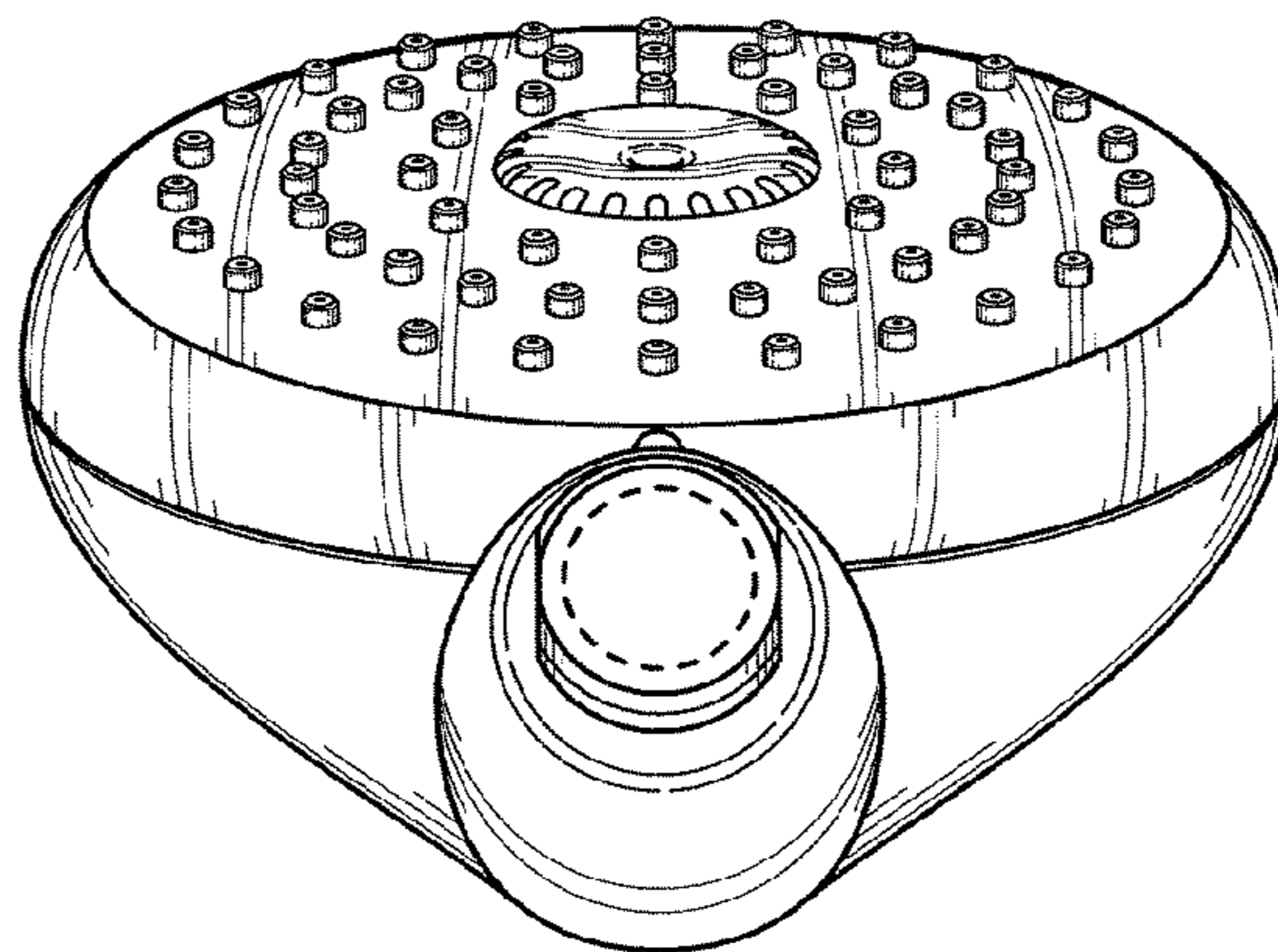

FIG. 6

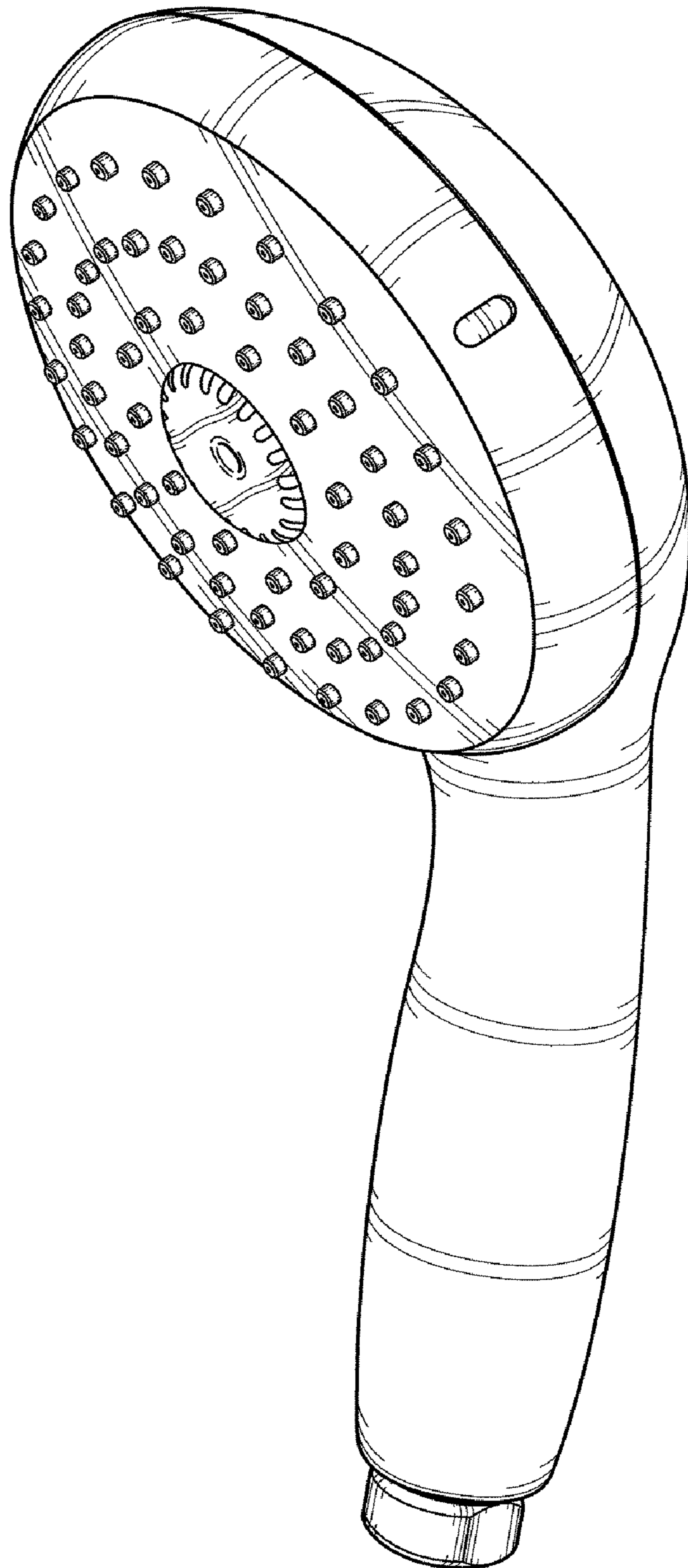

FIG. 7

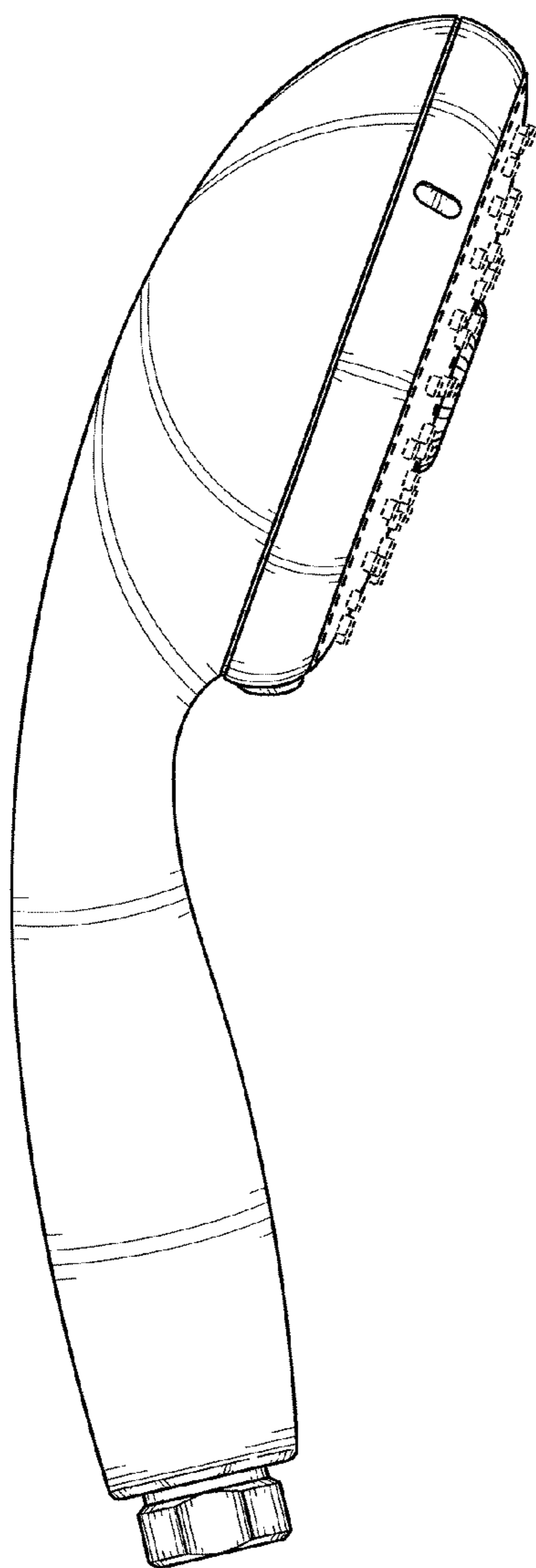

FIG. 8

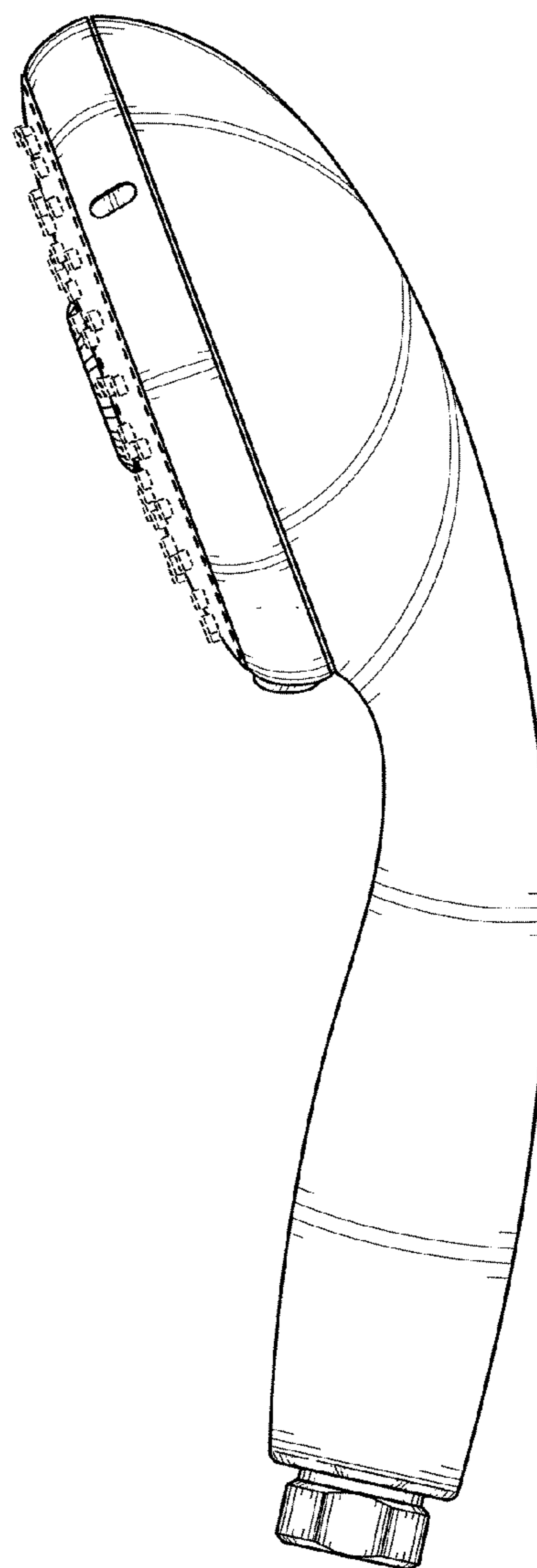

FIG. 9

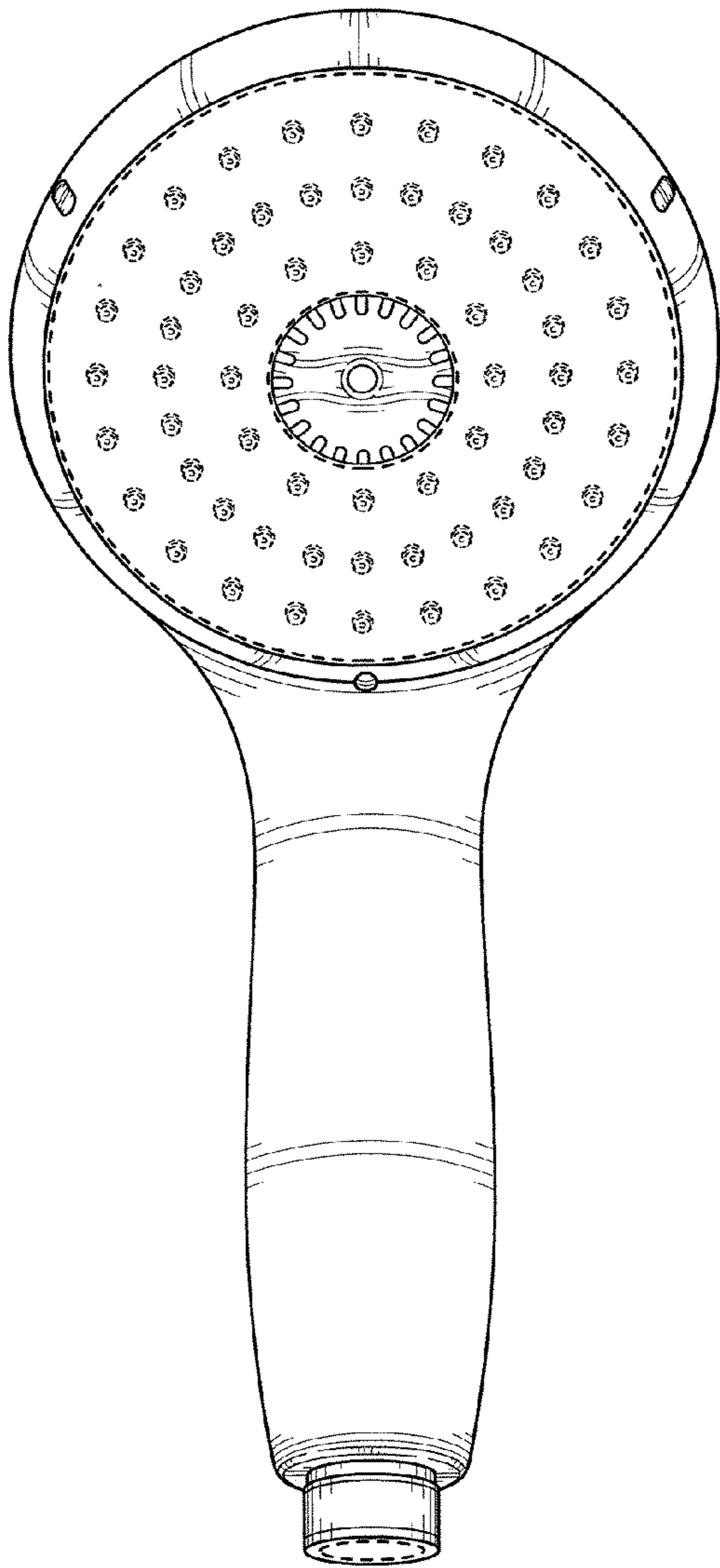

FIG. 10

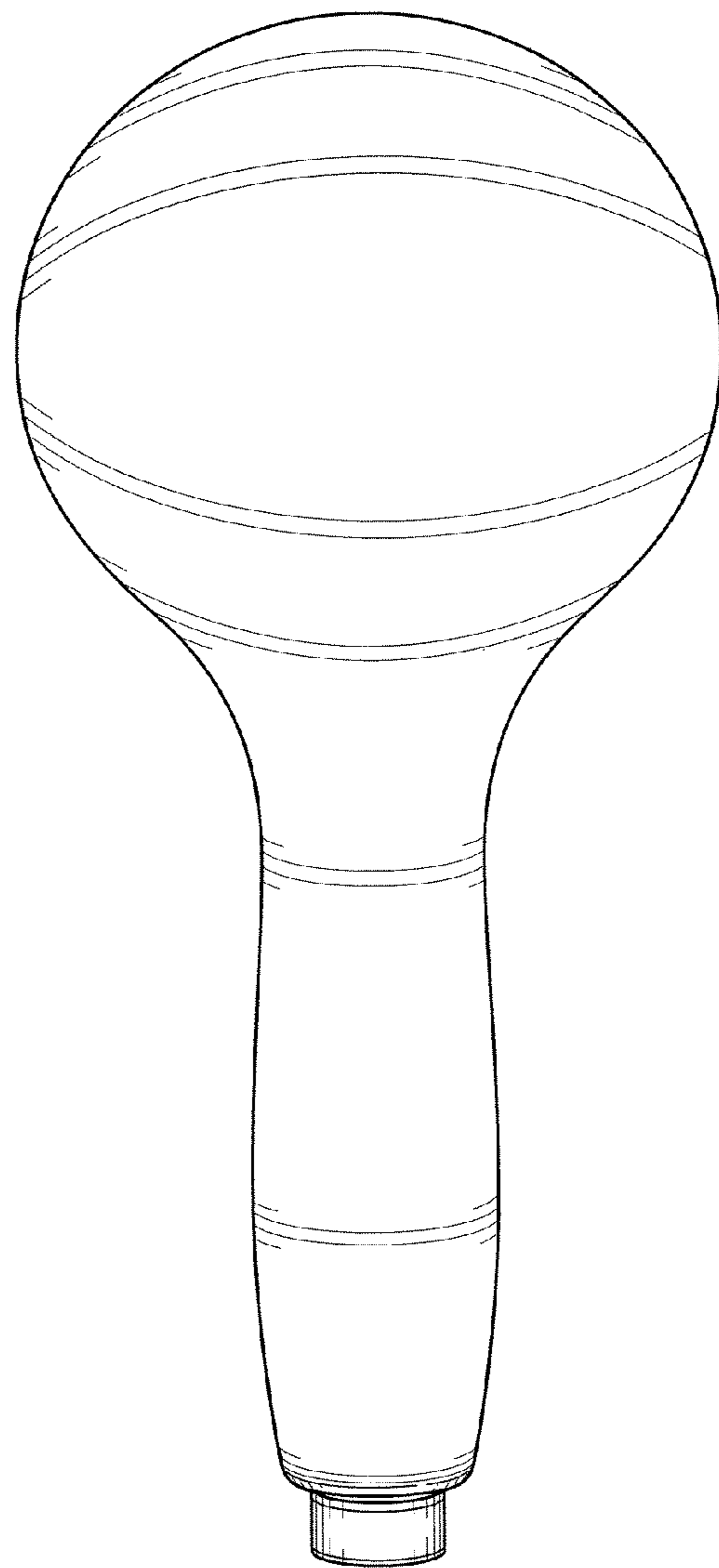

FIG. 11

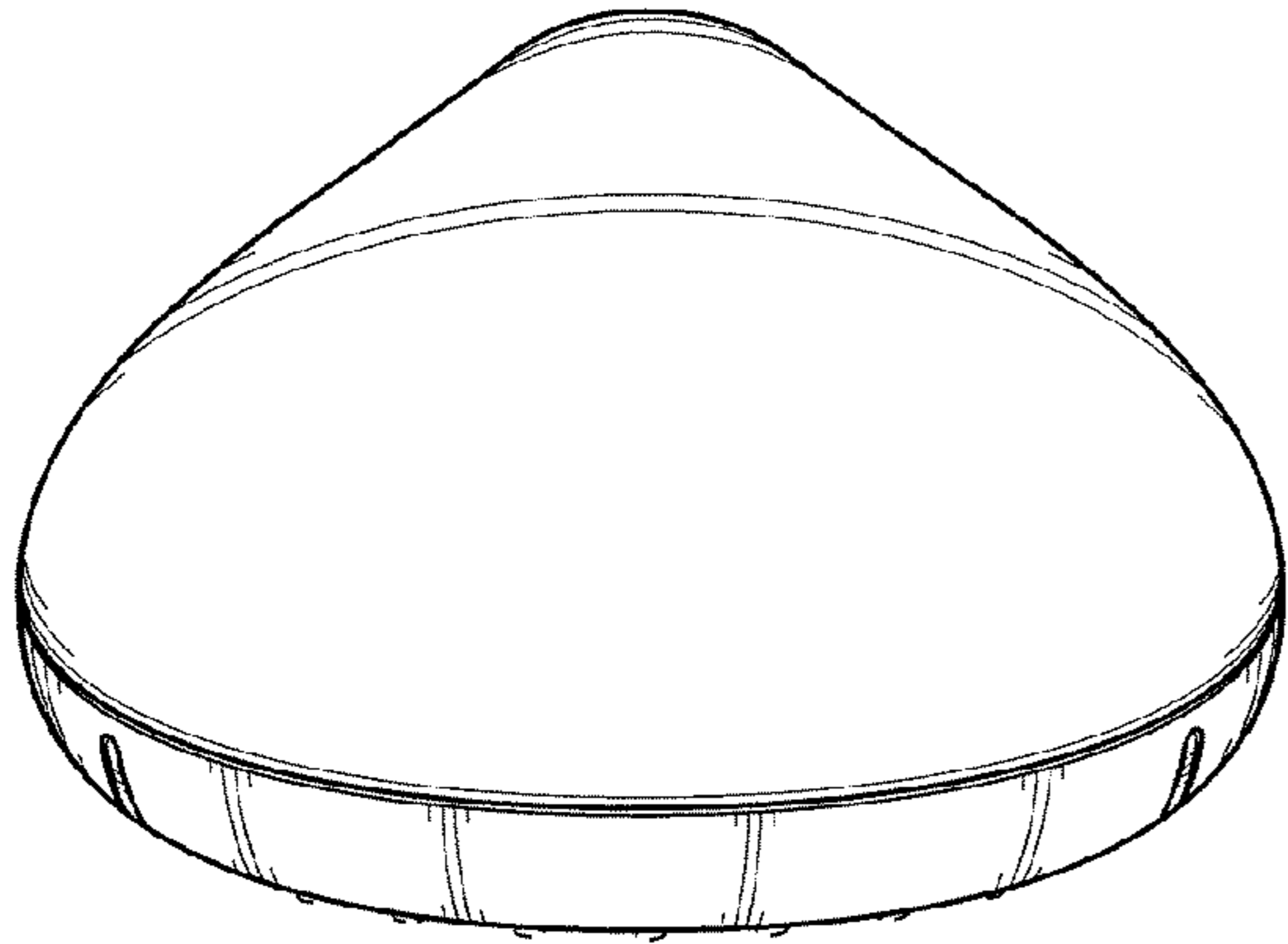

FIG. 12

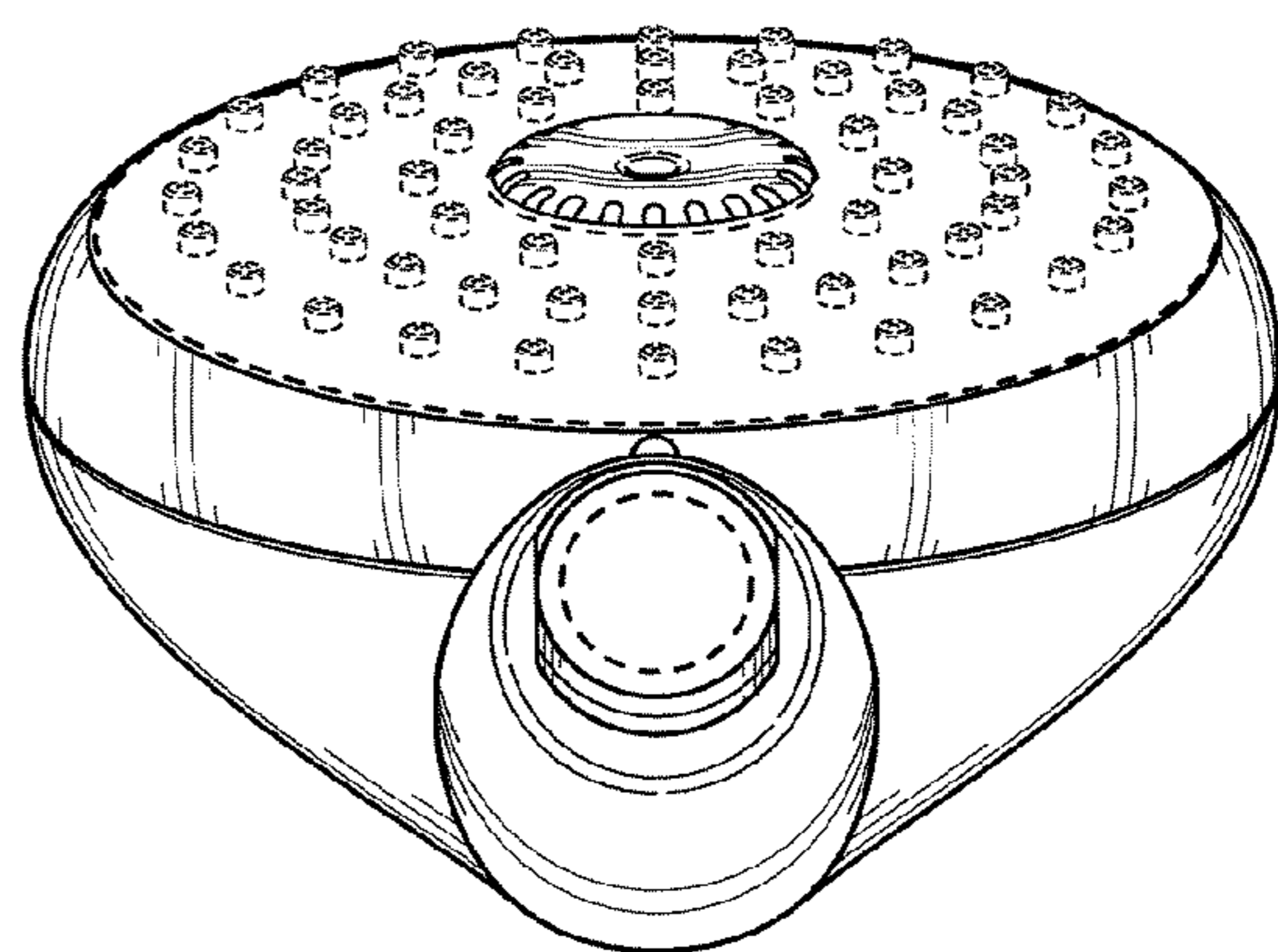

FIG. 13



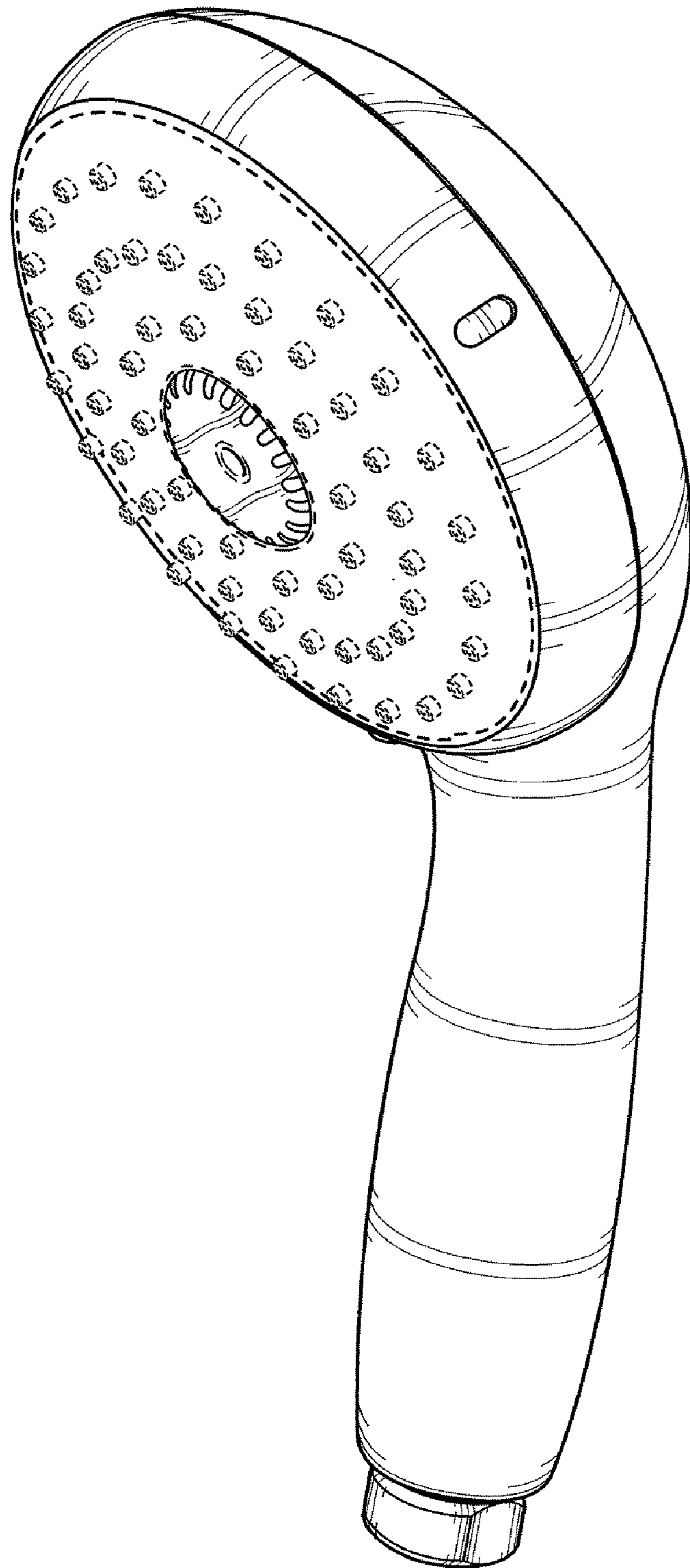

FIG. 14