



US00D655292S

(12) **United States Design Patent**
Nakata

(10) **Patent No.:** **US D655,292 S**
(45) **Date of Patent:** **** Mar. 6, 2012**

(54) **STYLUS PEN**

(75) **Inventor:** **Takaaki Nakata, Kuki (JP)**

(73) **Assignee:** **Wacom Co., Ltd., Saitama (JP)**

(**) **Term:** **14 Years**

(21) **Appl. No.:** **29/402,190**

(22) **Filed:** **Sep. 21, 2011**

(30) **Foreign Application Priority Data**

Apr. 8, 2011 (JP) 2011-008104

(51) **LOC (9) Cl.** **14-02**

(52) **U.S. Cl.** **D14/411**

(58) **Field of Classification Search** D8/61;
D14/411; D19/35, 36, 41-51, 54-58; 401/55,
401/99, 100, 104-107, 196, 197, 202, 208,
401/209, 213, 192, 195, 243; 708/107; 345/179,
345/173; 178/19.01; 700/94
See application file for complete search history.

(56) **References Cited**

U.S. PATENT DOCUMENTS

D321,207 S * 10/1991 Granoff D19/49
D333,133 S * 2/1993 Hirota D14/411
D357,676 S * 4/1995 Mundt et al. D14/411
D451,137 S * 11/2001 Reichmann D19/36
D458,635 S * 6/2002 Boyle et al. D19/36

D491,983 S * 6/2004 Izushima D19/49
D509,850 S * 9/2005 Bhavnani D19/36
D530,372 S * 10/2006 Sugino et al. D19/36
D584,772 S * 1/2009 Hackenberg et al. D19/51
D614,623 S * 4/2010 Crisp et al. D14/411
D628,640 S * 12/2010 Wang D19/50
D628,641 S * 12/2010 Zhang D19/50
D631,095 S * 1/2011 Mizutani D19/45

FOREIGN PATENT DOCUMENTS

EM 001180046-0015 11/2009
JP 664638 S 8/1985

* cited by examiner

Primary Examiner — Austin Murphy

(74) *Attorney, Agent, or Firm* — Christensen O'Connor Johnson Kindness PLLC

(57) **CLAIM**

The ornamental design for a stylus pen, as shown and described.

DESCRIPTION

FIG. 1 is a top front right isometric view of a stylus pen showing my new design;
FIG. 2 is a front elevation view thereof;
FIG. 3 is a left side elevation view thereof, wherein the right side elevation view is a mirror image of FIG. 3;
FIG. 4 is a rear elevation view thereof;
FIG. 5 is an enlarged top plan view thereof; and,
FIG. 6 is an enlarged bottom plan view thereof.

1 Claim, 3 Drawing Sheets

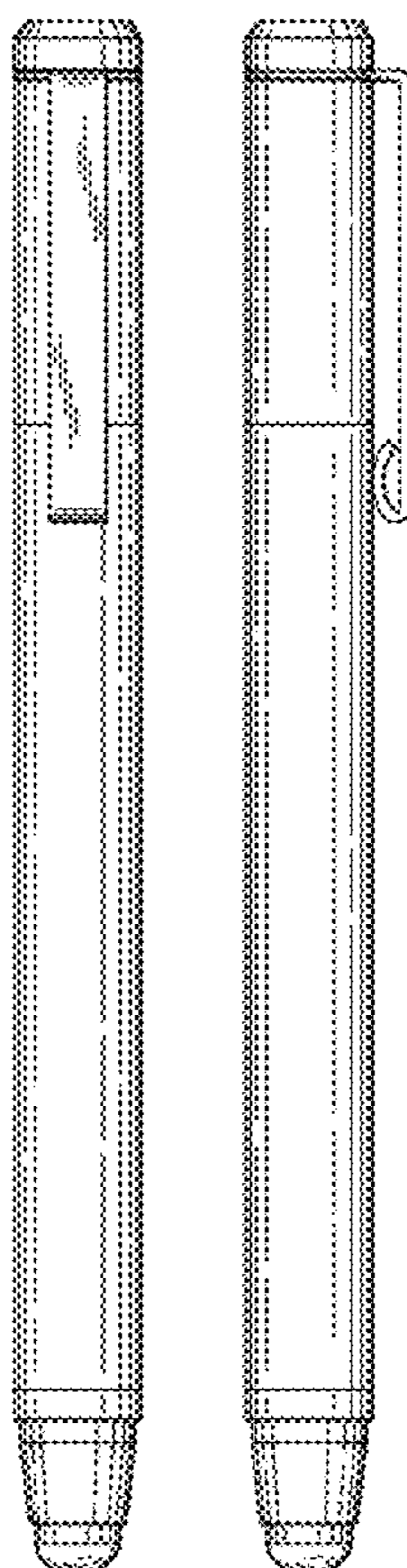

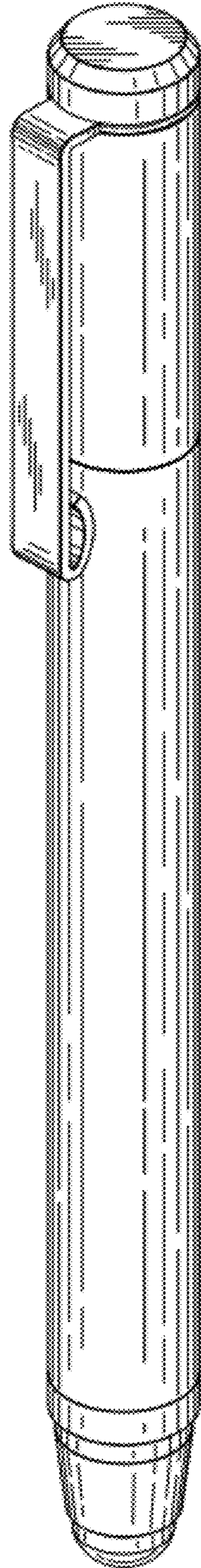

Fig. 1

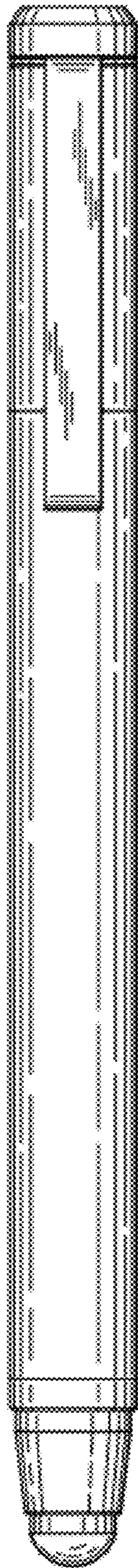

Fig. 2

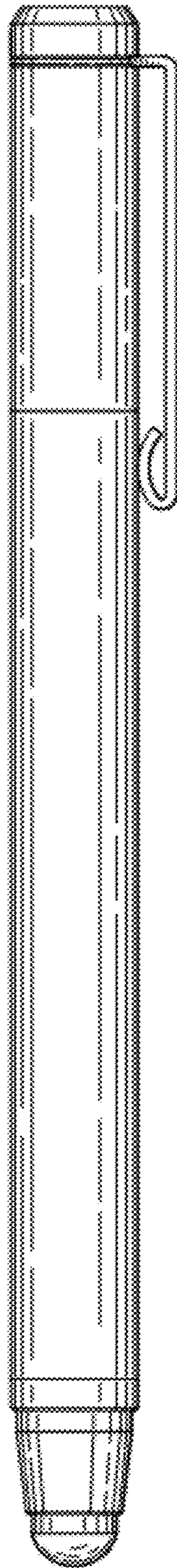

Fig. 3

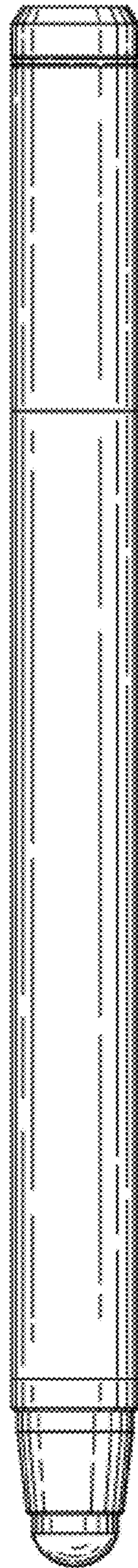

Fig. 4

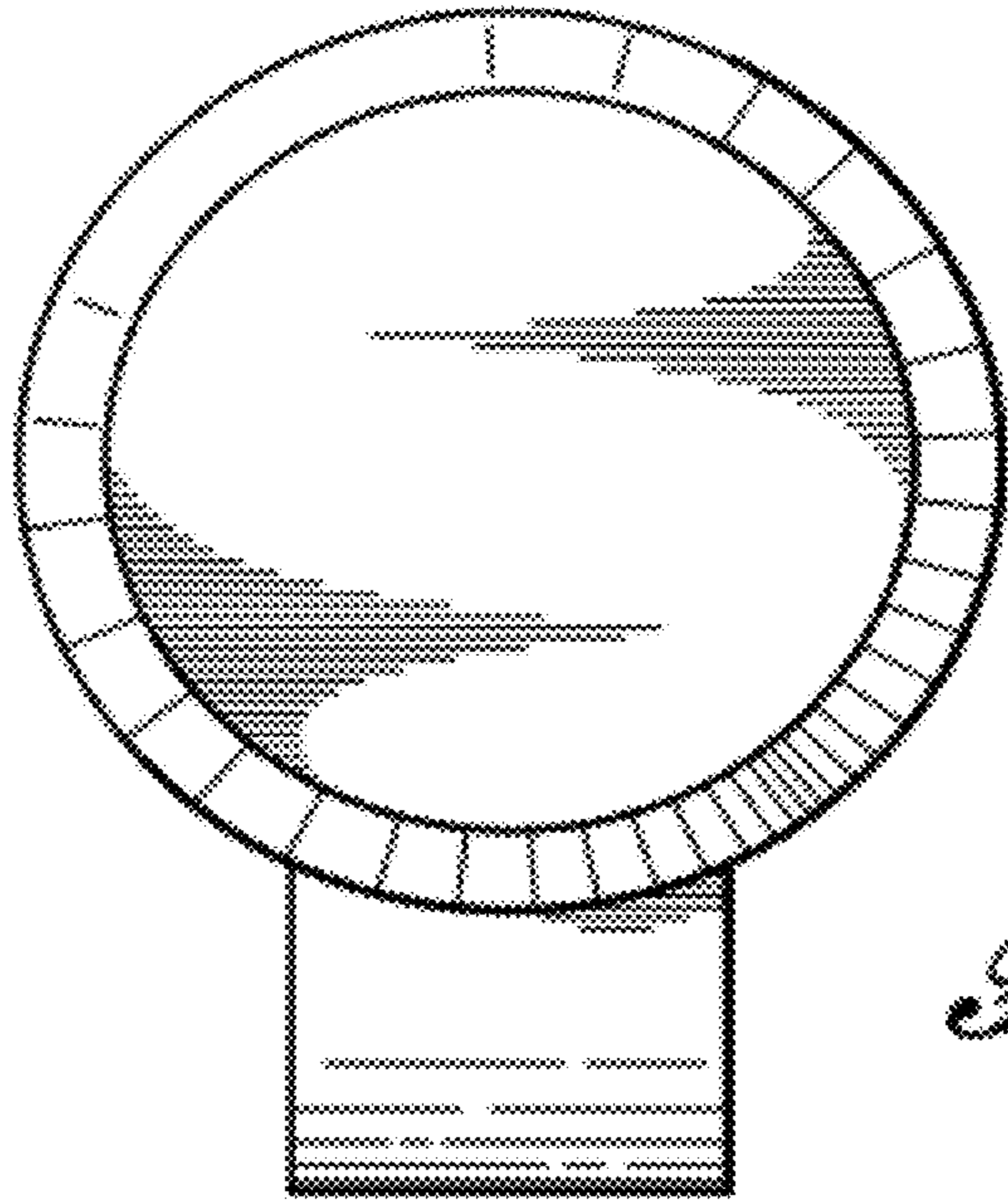

Fig. 5

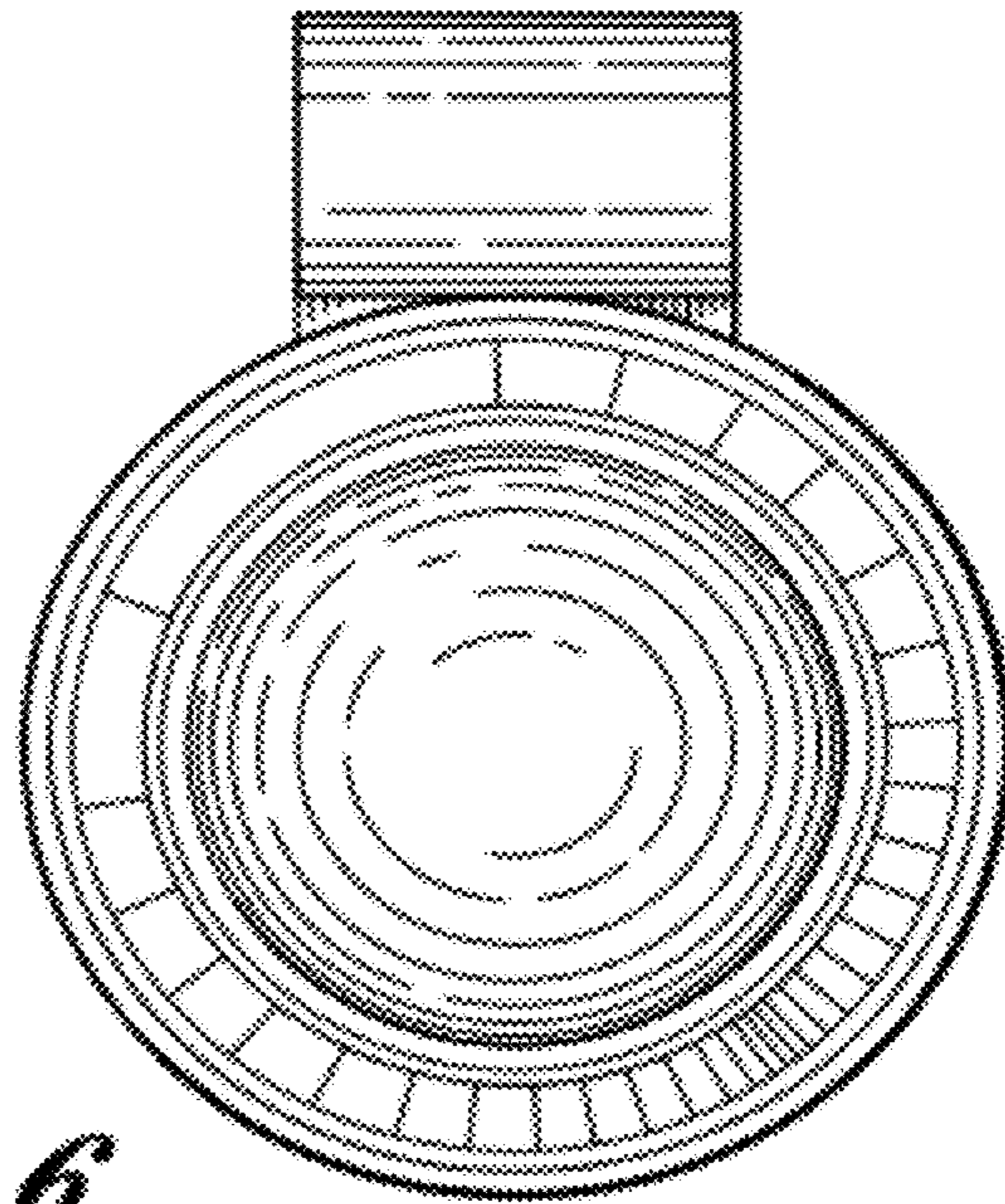

Fig. 6