



US00D655212S

(12) **United States Design Patent**  
**Wong**

(10) **Patent No.:** **US D655,212 S**  
(45) **Date of Patent:** **\*\* Mar. 6, 2012**

(54) **ELECTRICAL TESTER**

(75) Inventor: **Kingston Wong**, Beach Park, IL (US)

(73) Assignee: **Klein Tools, Inc.**, Lincolnshire, IL (US)

(\*\*) Term: **14 Years**

(21) Appl. No.: **29/369,074**

(22) Filed: **Sep. 1, 2010**

(51) **LOC (9) Cl.** ..... **10-04**

(52) **U.S. Cl.** ..... **D10/78**

(58) **Field of Classification Search** ..... D10/78;  
324/72.5, 556, 133, 149, 503, 543, 555, 66,  
324/72, 754, 115, 141, 114, 145, 156, 508;  
340/635, 687, 654; 379/21; 73/866.5  
See application file for complete search history.

(56) **References Cited**

**U.S. PATENT DOCUMENTS**

2,791,748	A	5/1957	Mitchell	
4,105,968	A	8/1978	Mobley et al.	
4,238,728	A	12/1980	Wells, Jr. et al.	
4,259,635	A	3/1981	Triplett	
4,825,150	A	4/1989	Sirasud	
D349,658	S	8/1994	Walsh	
5,543,707	A	8/1996	Yoneyama et al.	
D389,419	S	1/1998	Beha	
D391,504	S	3/1998	Arnoux et al.	
D400,454	S	11/1998	Arnoux et al.	
5,836,692	A	11/1998	Pompei	
D416,819	S *	11/1999	Luebke et al.	D10/78
6,137,285	A	10/2000	Walsten et al.	
D472,827	S	4/2003	Harju et al.	
7,208,932	B1	4/2007	Chun	
D583,266	S *	12/2008	Wong	D10/78
D628,917	S *	12/2010	Tian	D10/78
D629,319	S *	12/2010	Tian	D10/78
2002/0135349	A1 *	9/2002	Steber et al.	324/72.5
2009/0189597	A1 *	7/2009	Lagerberg et al.	324/133
2011/0156696	A1 *	6/2011	Cheek et al.	324/115

**OTHER PUBLICATIONS**

Photographs of the Etcon VT157 voltage tester pre-2010.

Pricelist for Etcon VT157 voltage tester dated 1995.

\* cited by examiner

*Primary Examiner* — Antoine D Davis

(74) *Attorney, Agent, or Firm* — McDonnell Boehnen Hulbert & Berghoff

(57) **CLAIM**

The ornamental design for an electrical tester, as shown and described.

**DESCRIPTION**

FIG. 1 is an electrical tester in a perspective view; FIG. 2 is a left side view thereof; FIG. 3 is a front view thereof; FIG. 4 is a right side view thereof; FIG. 5 is a rear view thereof; FIG. 6 is a top side view thereof; and FIG. 7 is a bottom view thereof. FIG. 8 is a second embodiment of an electrical tester in a perspective view; FIG. 9 is a left side view thereof; FIG. 10 is a front view thereof; FIG. 11 is a right side view thereof; FIG. 12 is a rear view thereof; FIG. 13 a top side view thereof; and, FIG. 14 is a bottom view thereof. FIG. 15 is a third embodiment of an electrical tester in a perspective view; FIG. 16 is a left side view thereof; FIG. 17 is a front view thereof; FIG. 18 is a right side view thereof; FIG. 19 is a rear view thereof; FIG. 20 is a top side view thereof; and, FIG. 21 is a bottom view thereof. The broken lines shown in the drawings represent environmental structure and form no part of the claimed design. The stippled area shown in FIGS. 15-21 is an area having a color that is different than the non-stippled area of the design.

**1 Claim, 12 Drawing Sheets**

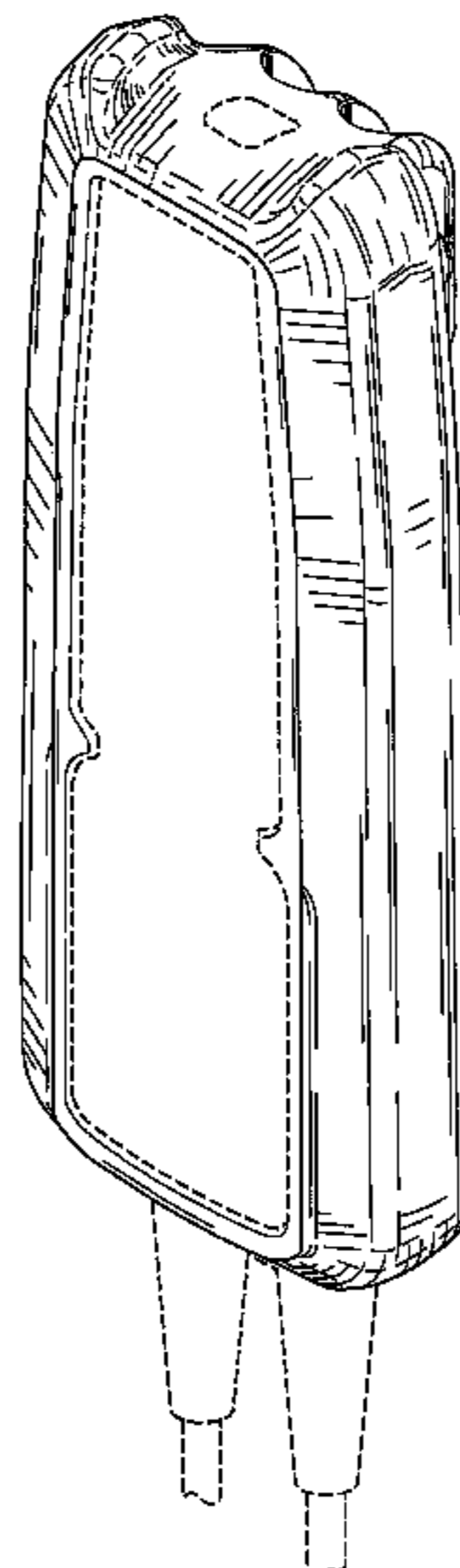

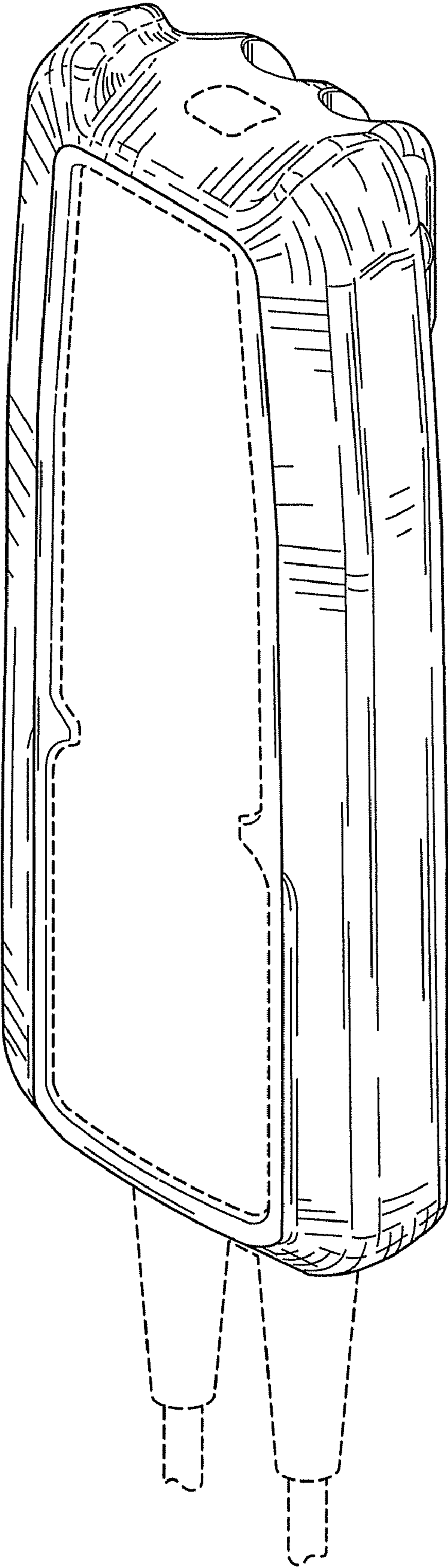

FIG. 1

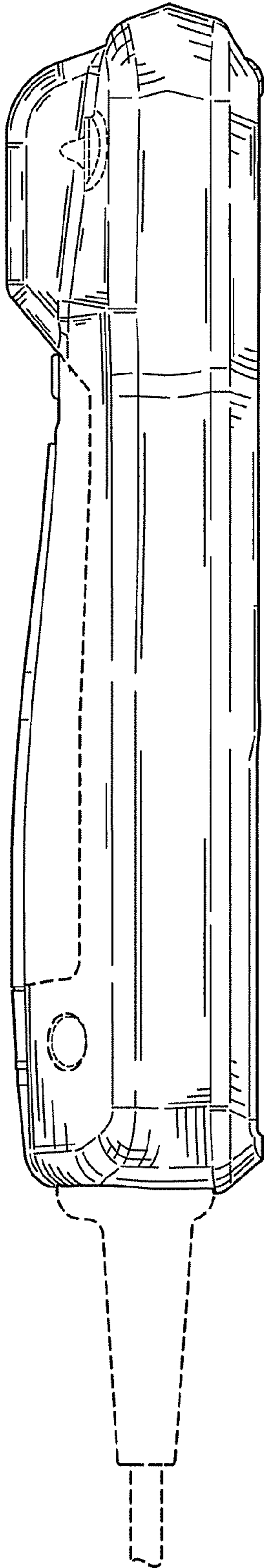

FIG. 2

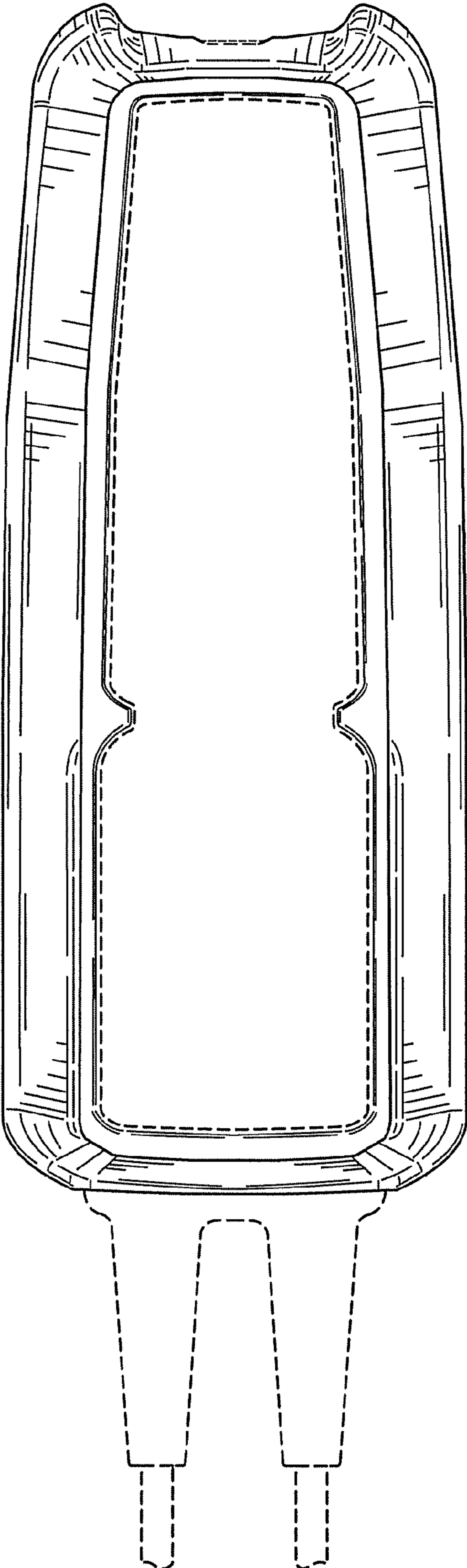

FIG. 3

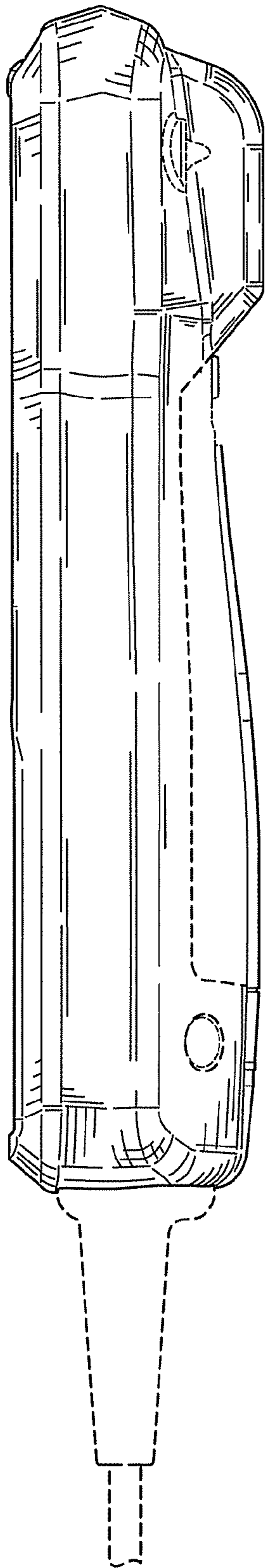

FIG. 4

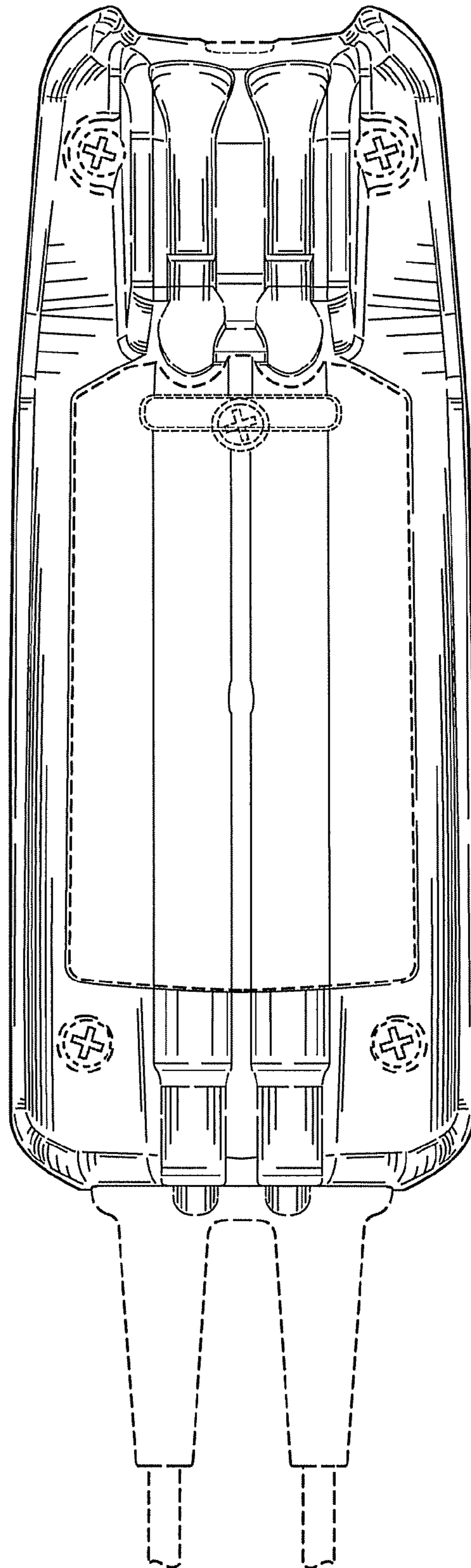

FIG. 5

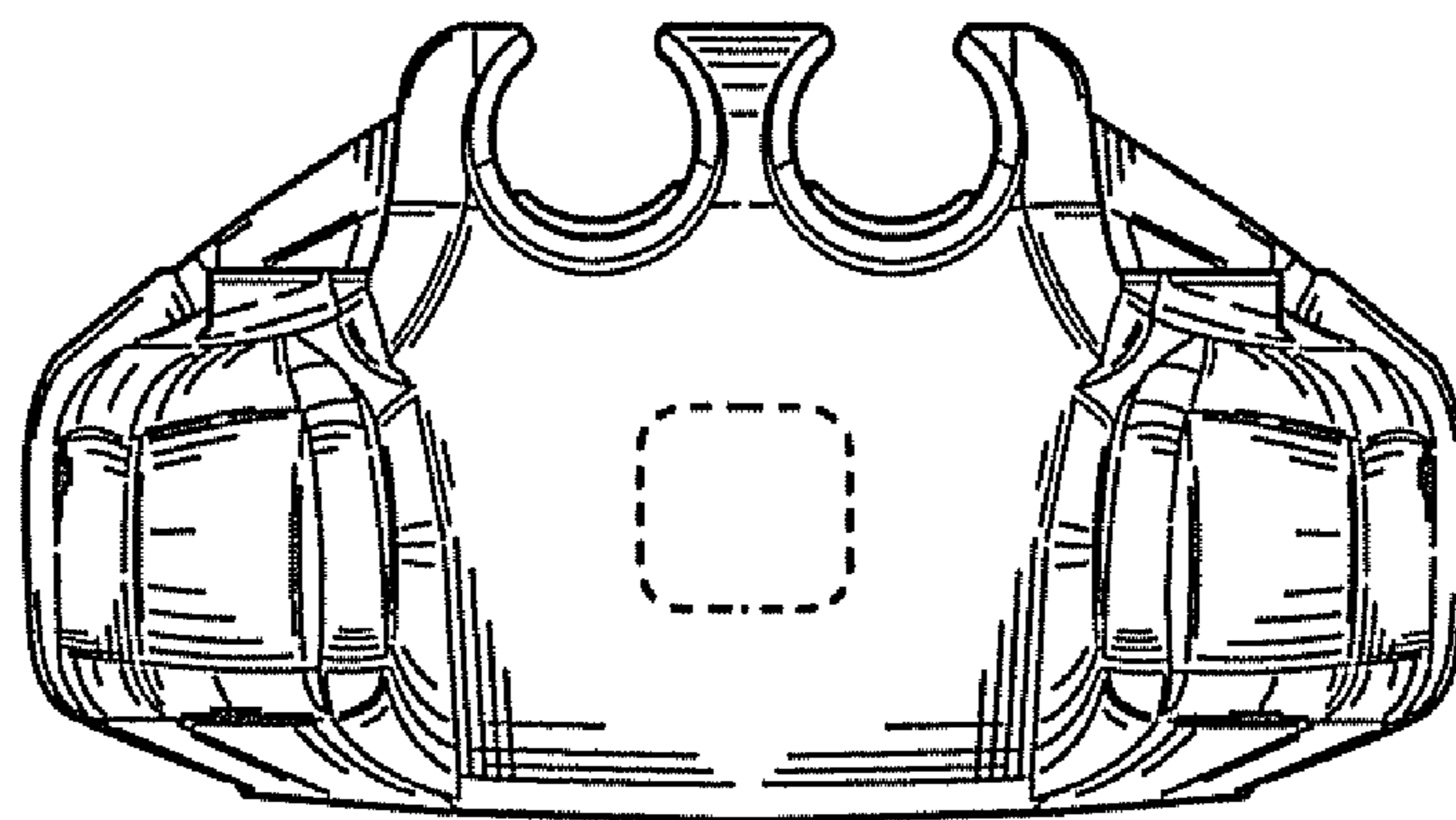

FIG. 6

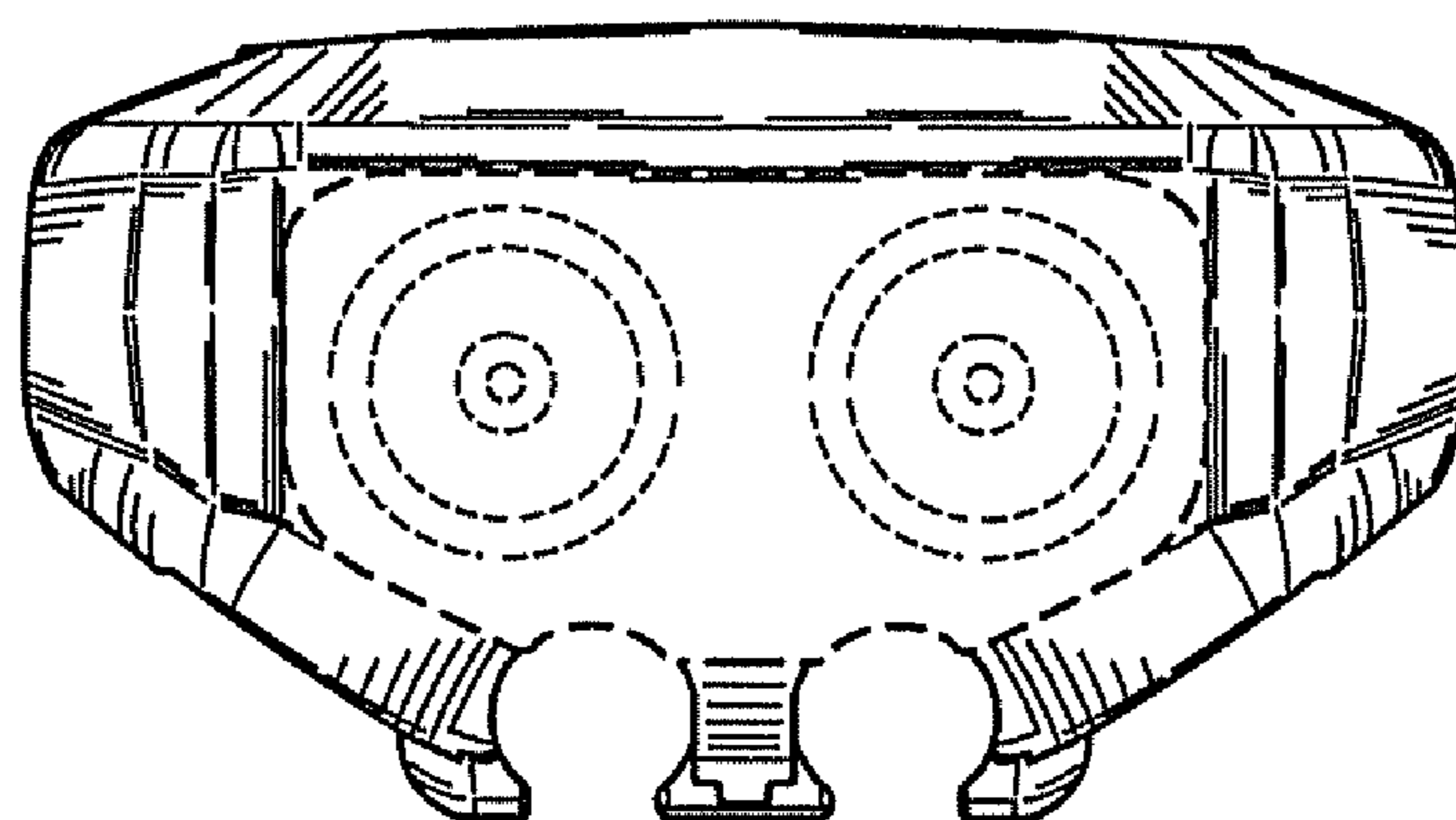

FIG. 7



FIG. 8

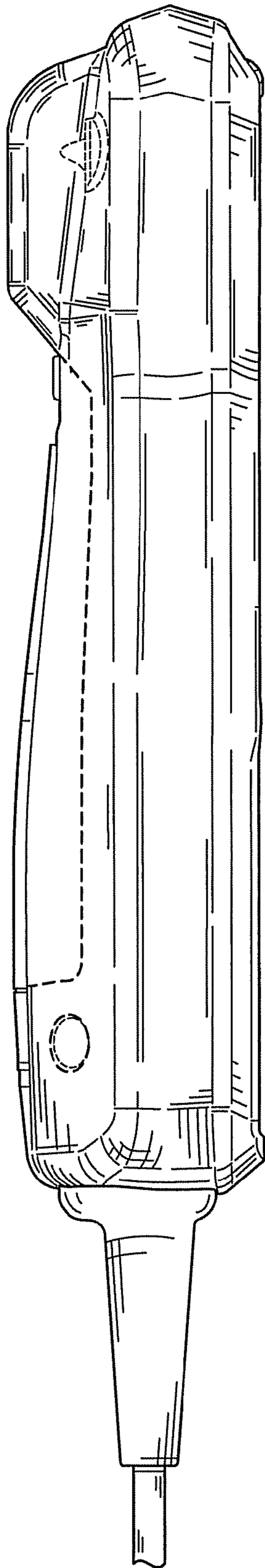

FIG. 9

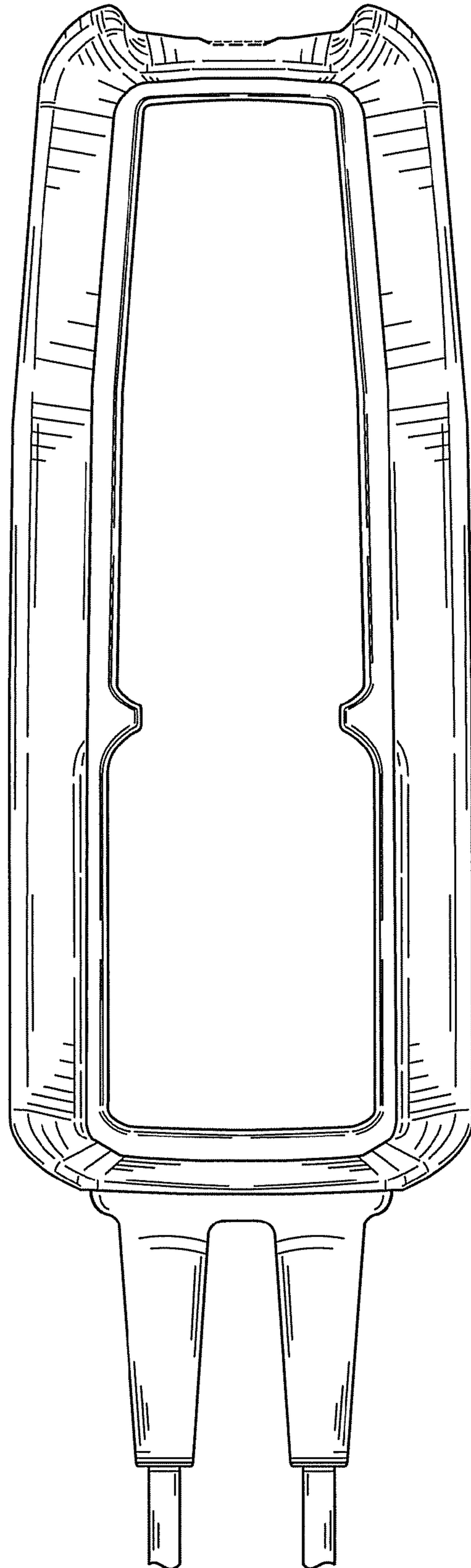

FIG. 10

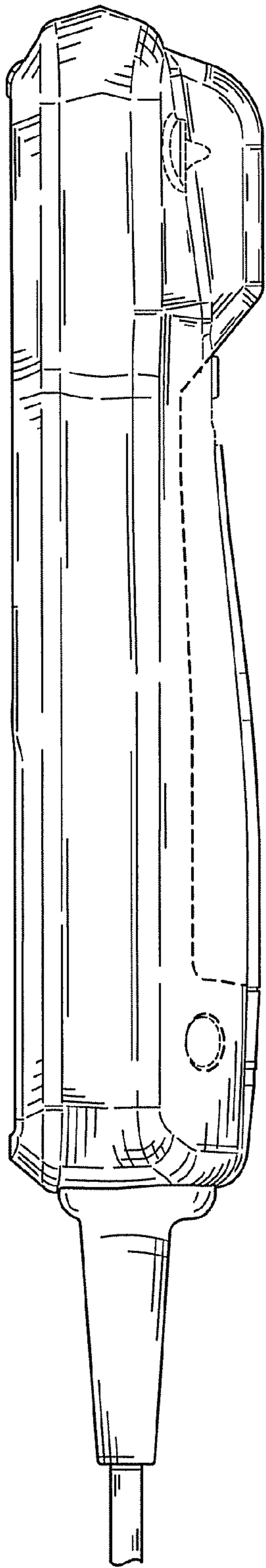

FIG. 11

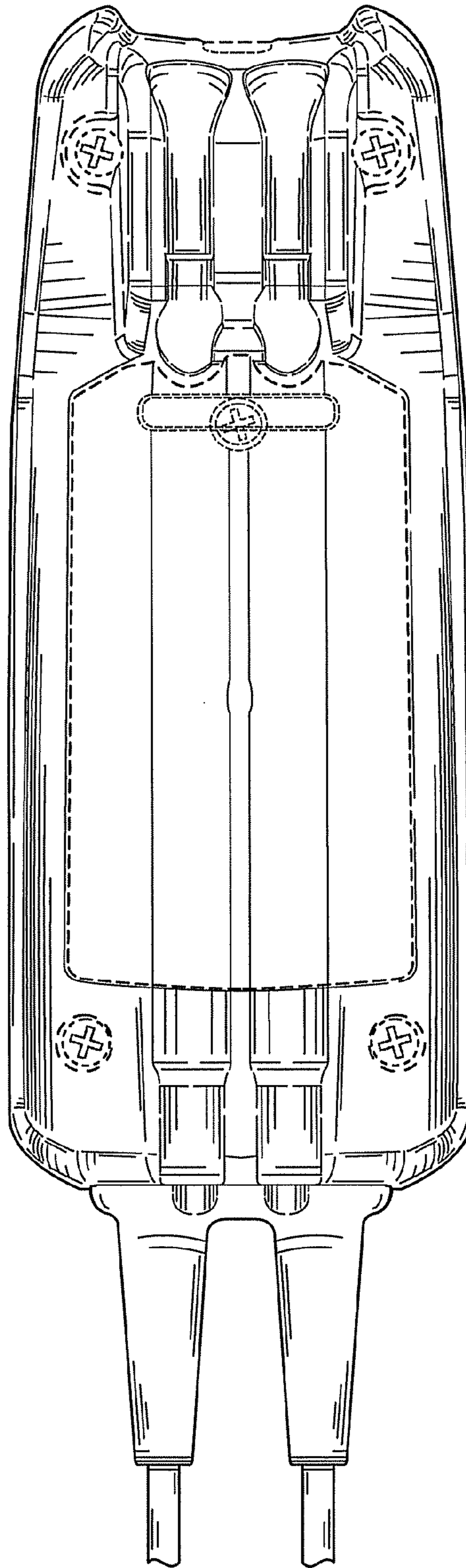

FIG. 12



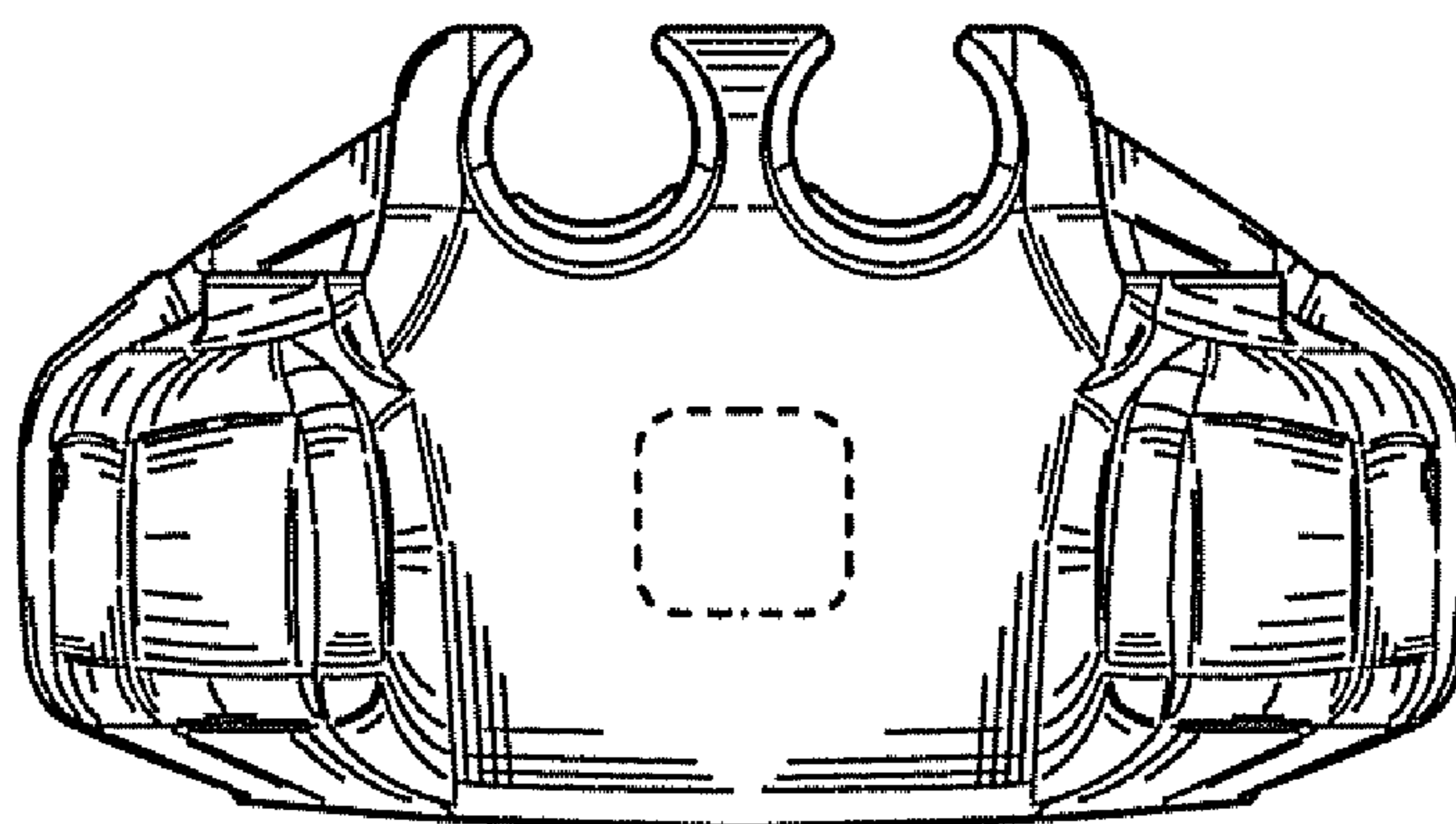

FIG. 13

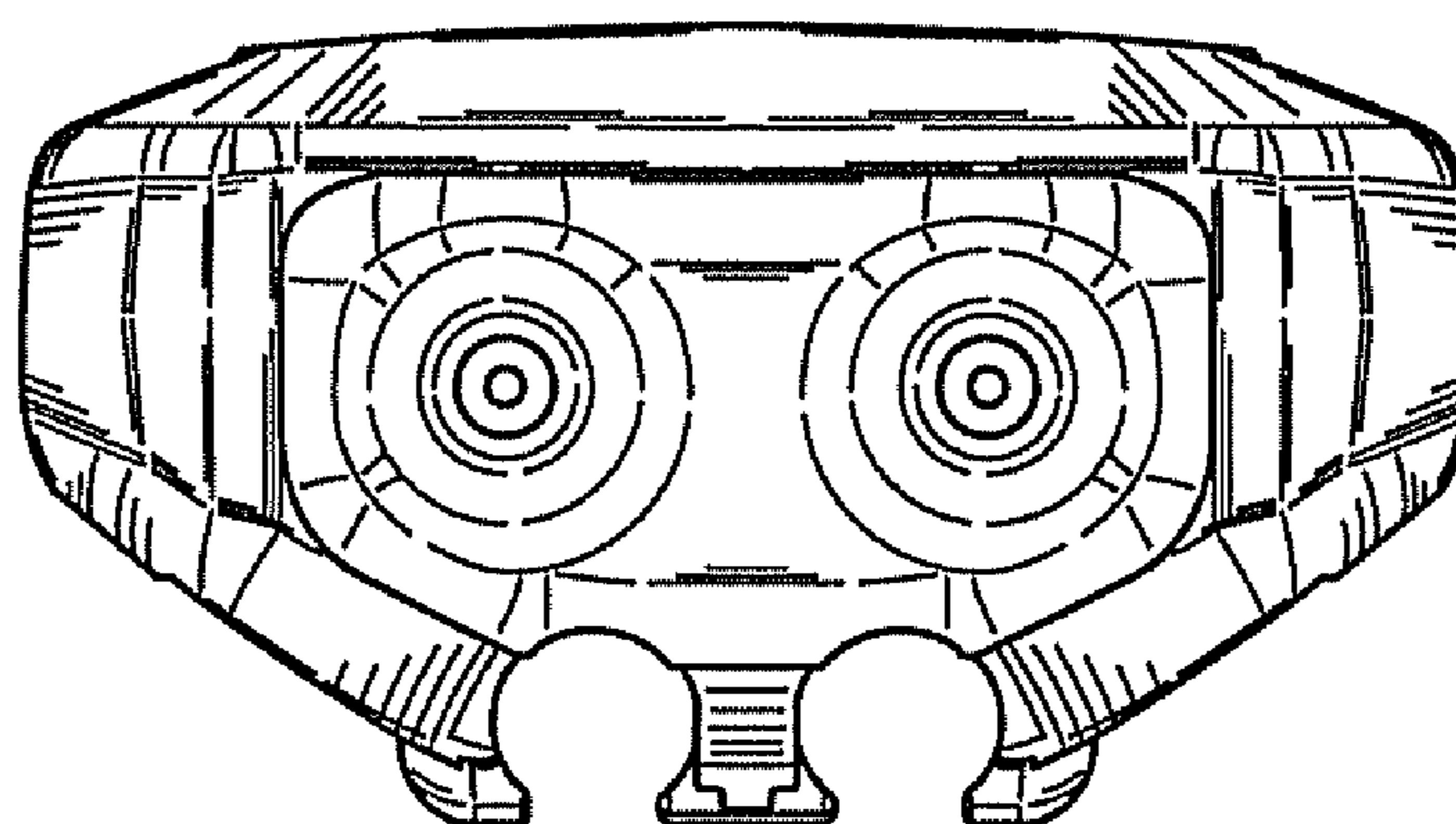

FIG. 14

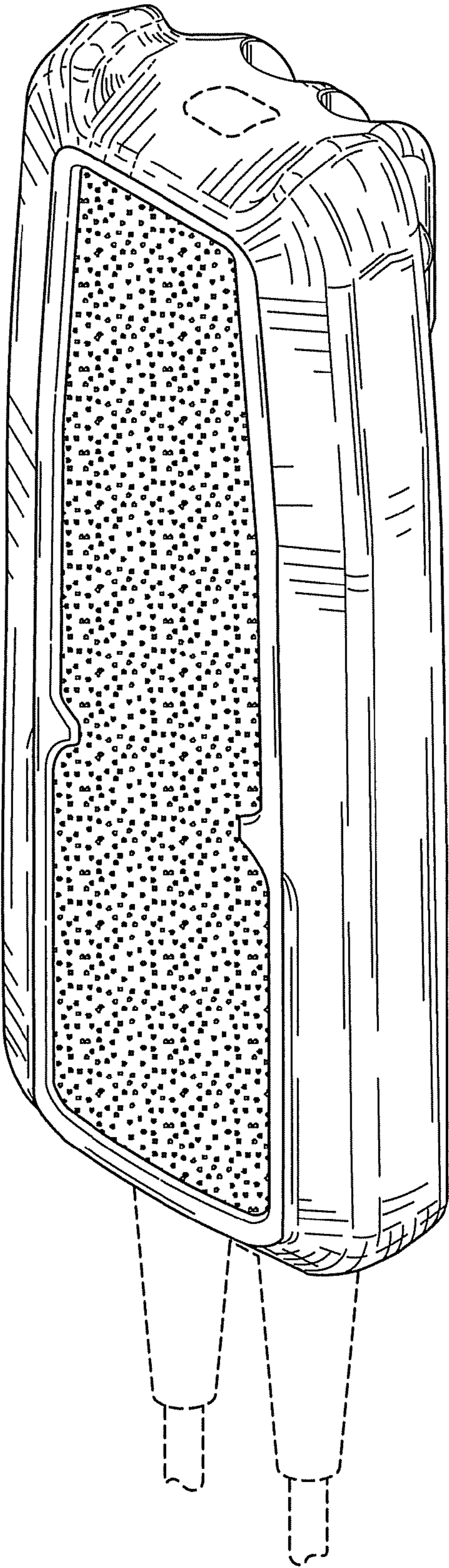

FIG.15

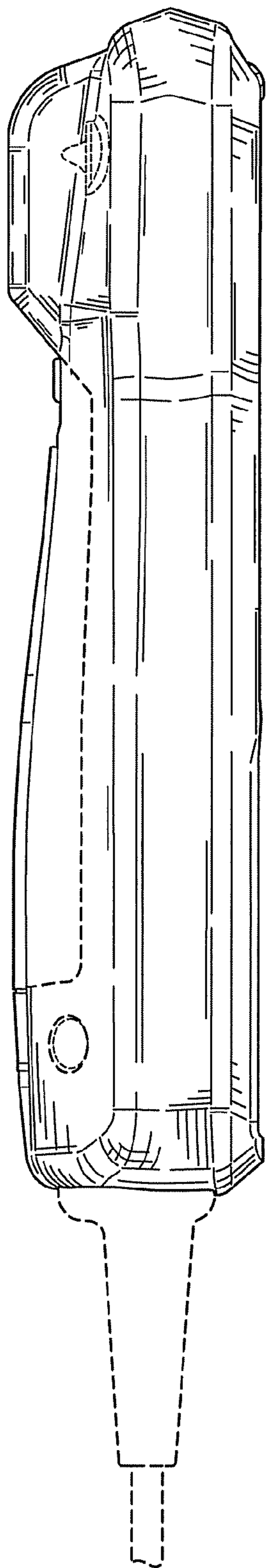

FIG. 16

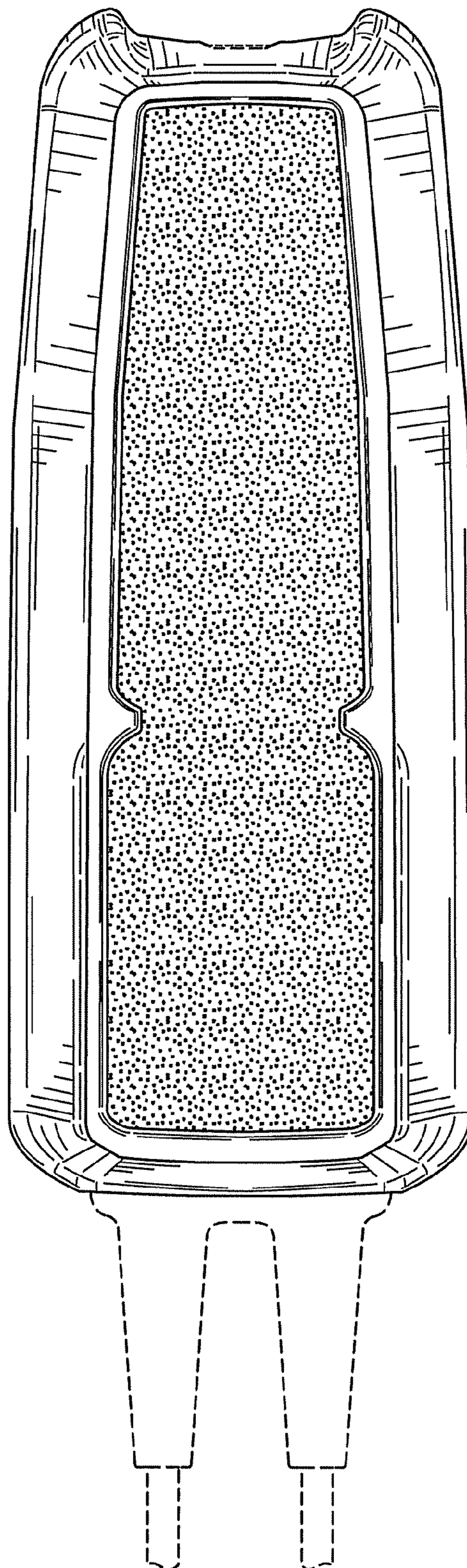

FIG. 17

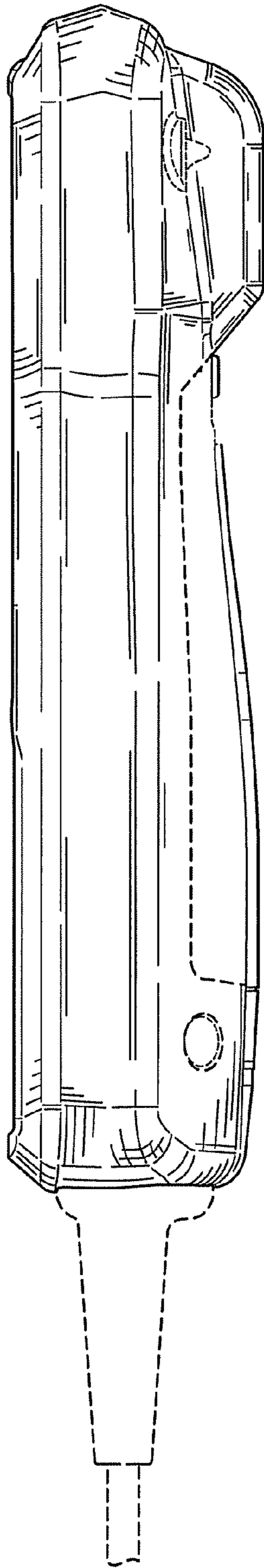

FIG. 18

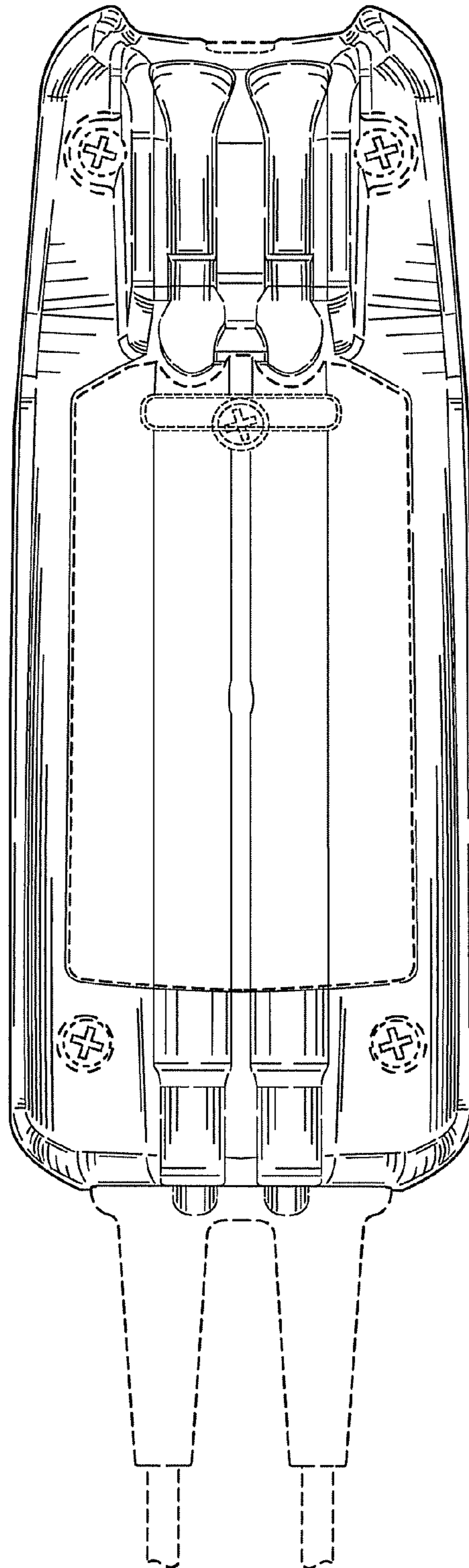

FIG. 19

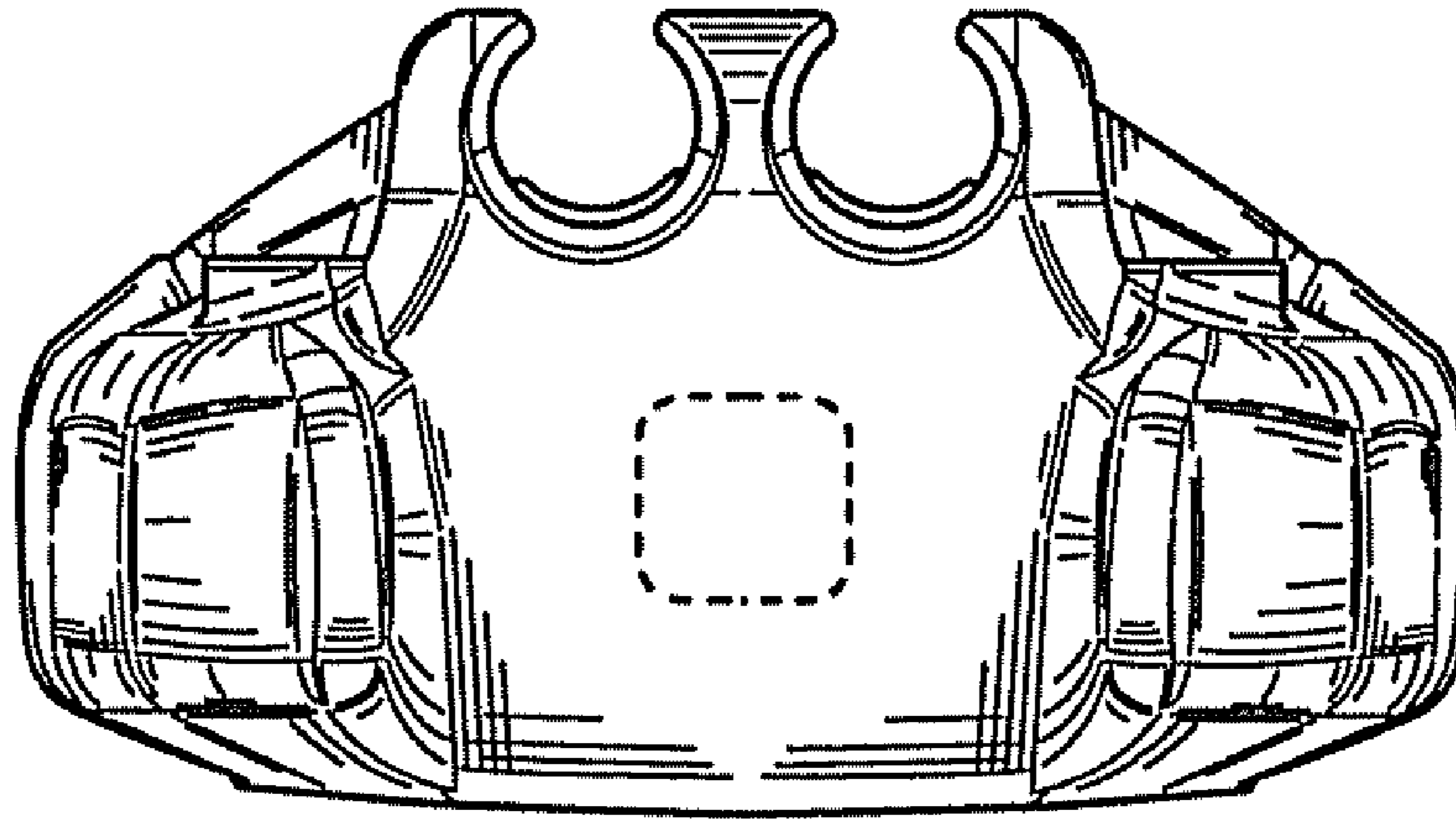

FIG. 20

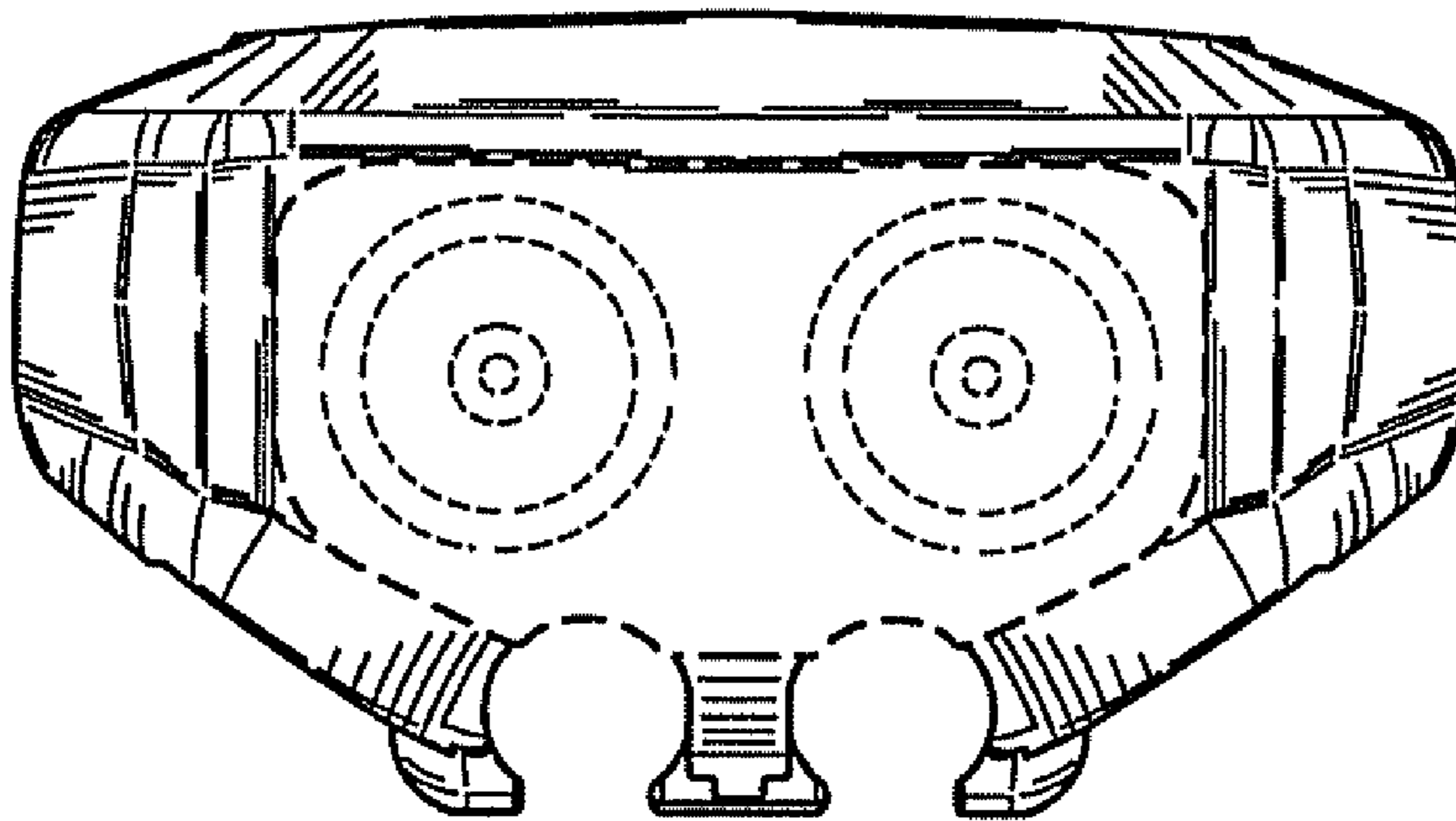

FIG. 21