



US00D655211S

(12) **United States Design Patent**  
**McEwan et al.**

(10) **Patent No.:** **US D655,211 S**  
(45) **Date of Patent:** **\*\* Mar. 6, 2012**

(54) **TAPE MEASURE HOUSING**

*Primary Examiner* — Antoine D Davis

(74) *Attorney, Agent, or Firm* — Coats & Bennett, P.L.L.C.

(75) Inventors: **Sean M. McEwan**, Fuquay-Varina, NC (US); **Phillip J. Nathan**, Royal Oak, MI (US); **Robert H. Bruno**, Avon, CT (US); **Peter James Everett**, Collinsville, CT (US)

(57) **CLAIM**

The ornamental design for a tape measure housing, as shown and described.

(73) Assignee: **Apex Brands, Inc.**, Sparks, MD (US)

**DESCRIPTION**

(\*\*) Term: **14 Years**

(21) Appl. No.: **29/393,616**

(22) Filed: **Jun. 7, 2011**

(51) **LOC (9) Cl.** ..... **10-04**

(52) **U.S. Cl.** ..... **D10/72**

(58) **Field of Classification Search** ..... D10/72,  
D10/74; 33/755-771; 242/285, 291, 379,  
242/379.1, 379.2, 381, 381.1-381.6, 405  
See application file for complete search history.

FIG. 1 is a front perspective view of a first embodiment of a tape measure housing showing our design.  
FIG. 2 is a left side view of the first embodiment.  
FIG. 3 is a right side view of the first embodiment.  
FIG. 4 is a front view of the first embodiment.  
FIG. 5 is a rear view of the first embodiment.  
FIG. 6 is a top view of the first embodiment.  
FIG. 7 is a bottom view of the first embodiment.  
FIG. 8 is a front perspective view of a second embodiment of a tape measure housing showing our design.  
FIG. 9 is a left side view of the second embodiment.  
FIG. 10 is a right side view of the second embodiment.  
FIG. 11 is a front view of the second embodiment.  
FIG. 12 is a rear view of the second embodiment.  
FIG. 13 is a top view of the second embodiment; and,  
FIG. 14 is a bottom view of the second embodiment.  
The broken lines are environmental only and form no part of the claimed design. The surface stippling represents a contrast of color, texture, or material.

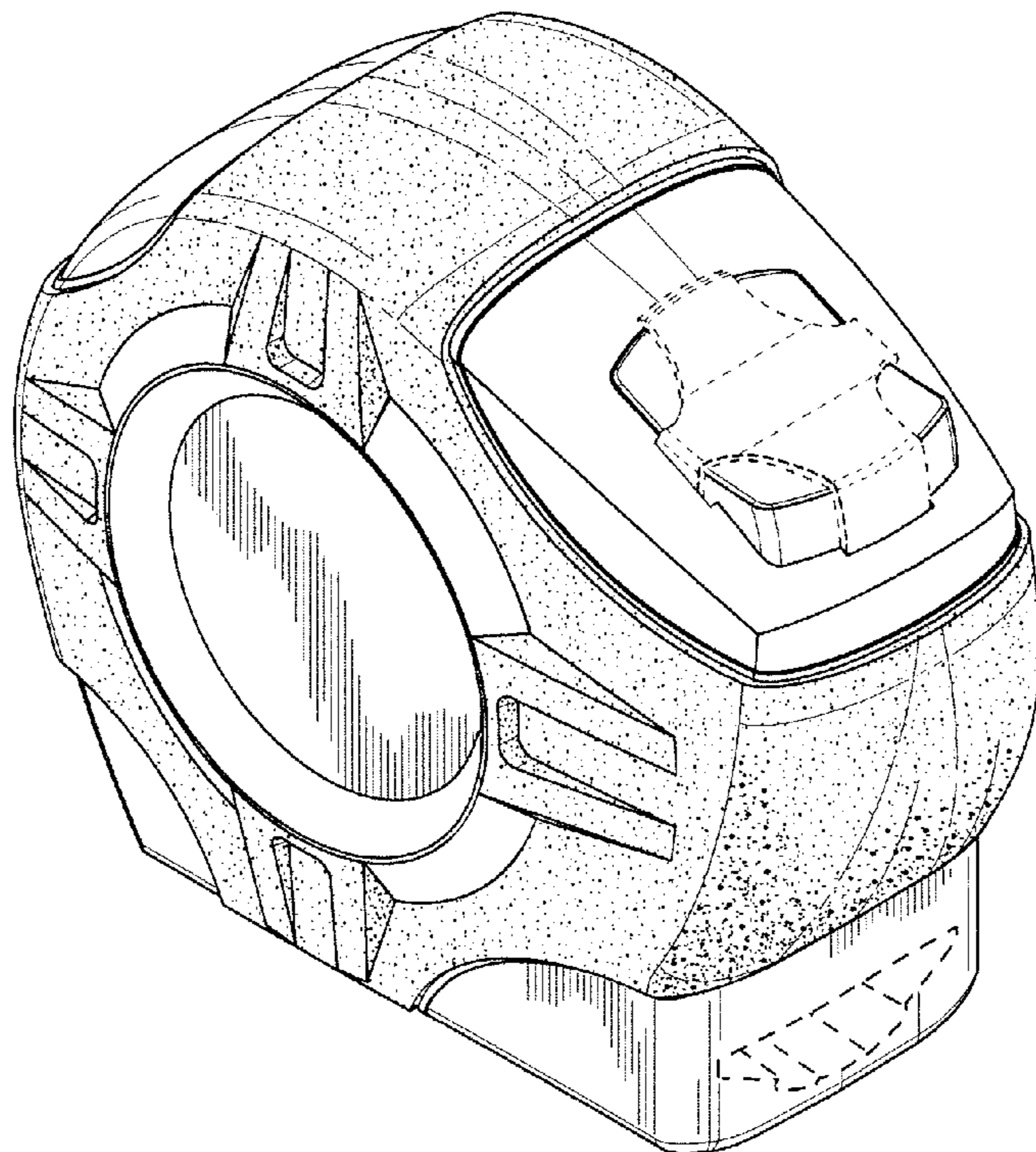
(56) **References Cited**

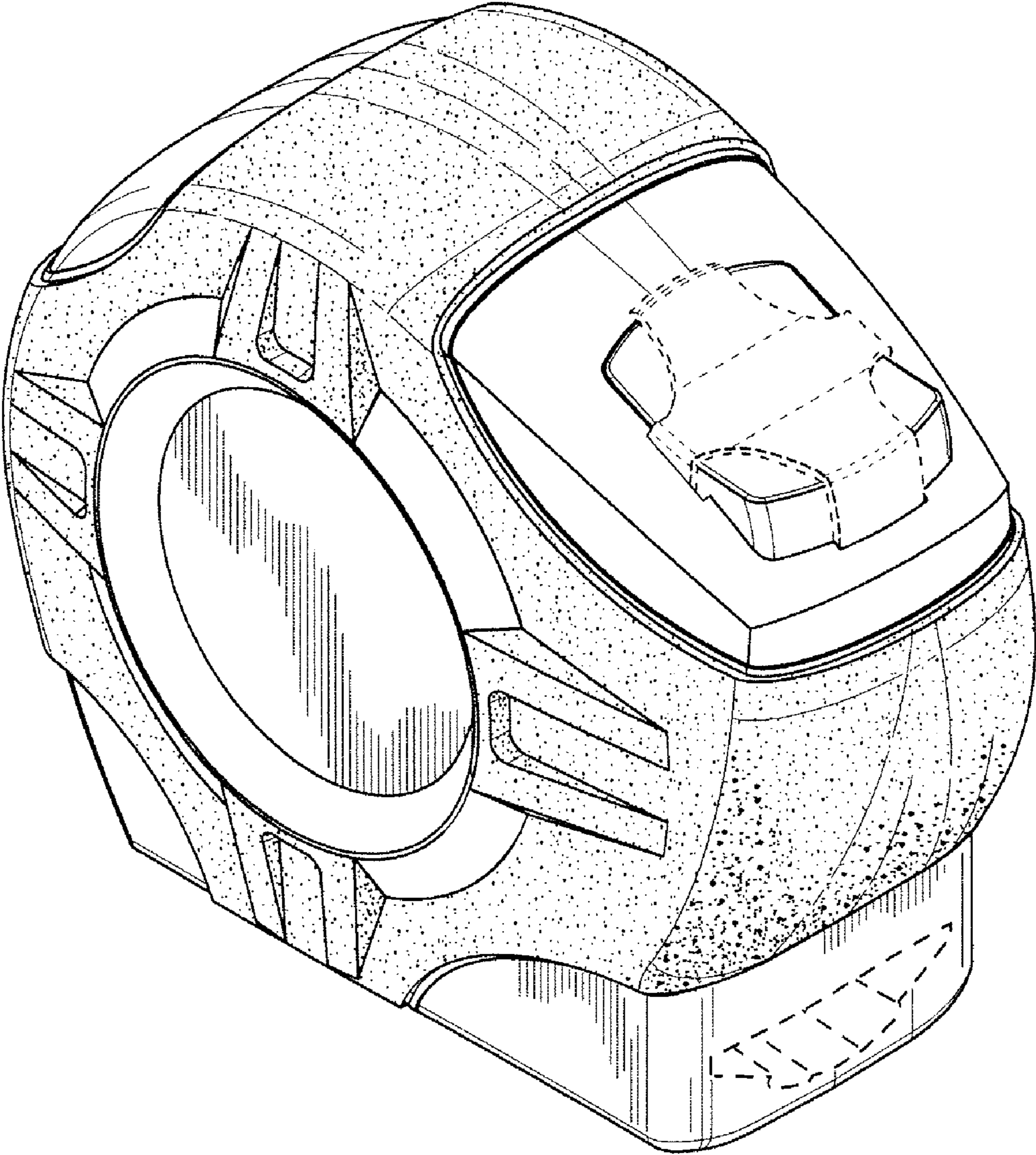
U.S. PATENT DOCUMENTS

D318,815 S *	8/1991	Chapin	.....	D10/72
D438,129 S *	2/2001	Li	.....	D10/72
D439,176 S *	3/2001	Lin	.....	D10/72
D453,302 S *	2/2002	Liu	.....	D10/72
D459,253 S *	6/2002	von Wedemeyer	.....	D10/72
D461,136 S *	8/2002	Lin	.....	D10/72

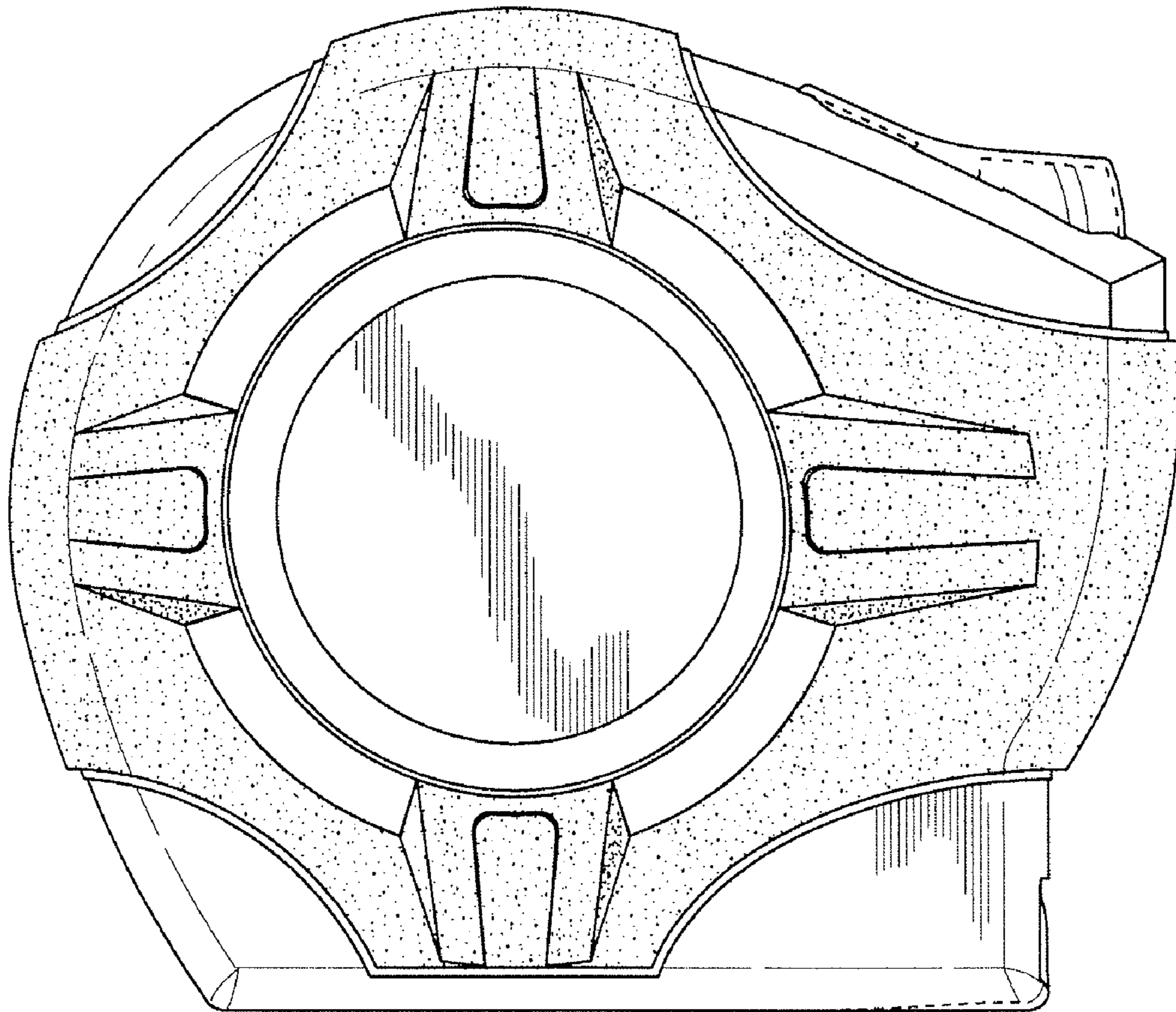
\* cited by examiner

**1 Claim, 14 Drawing Sheets**





**FIG. 1**



**FIG. 2**

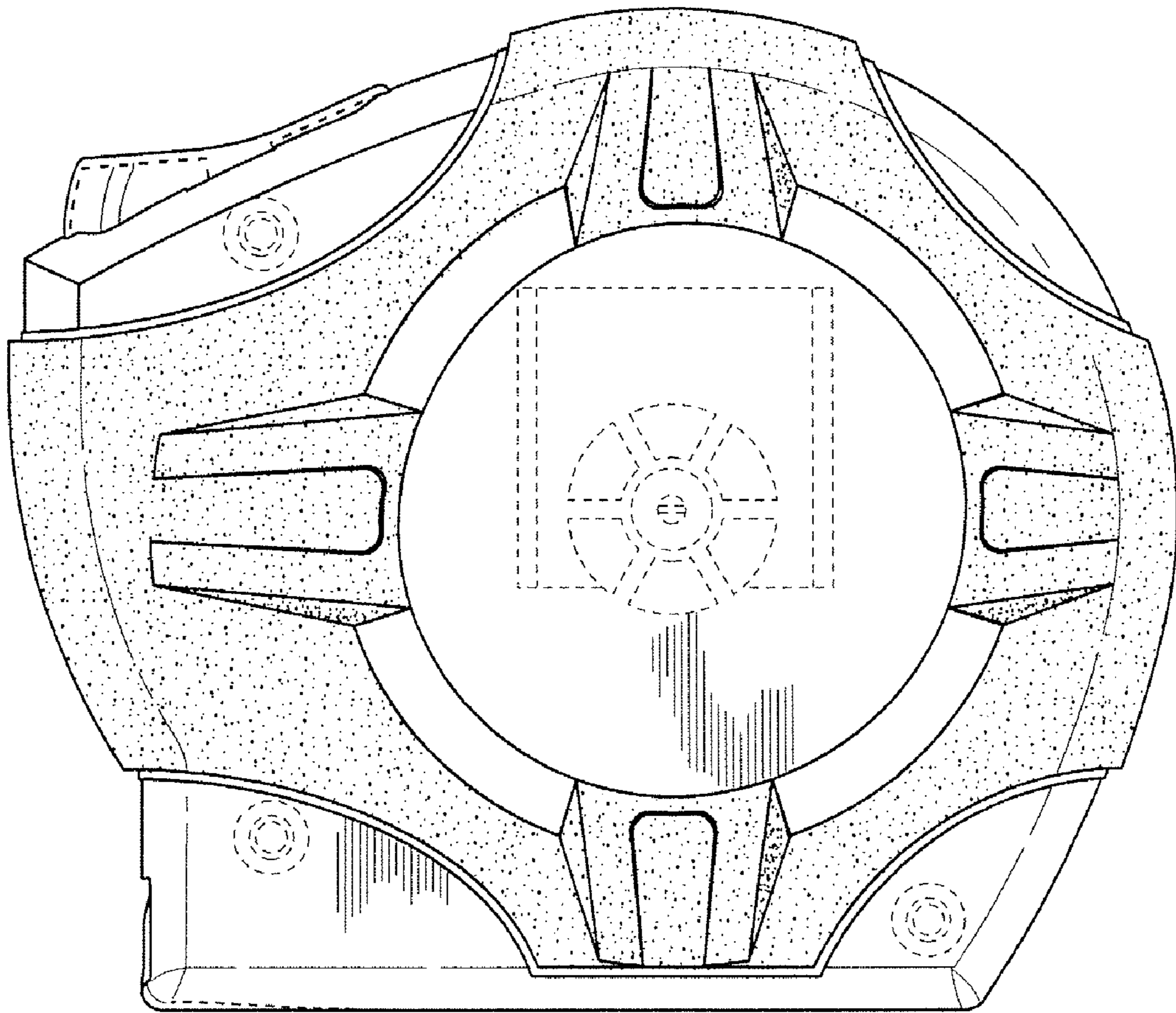
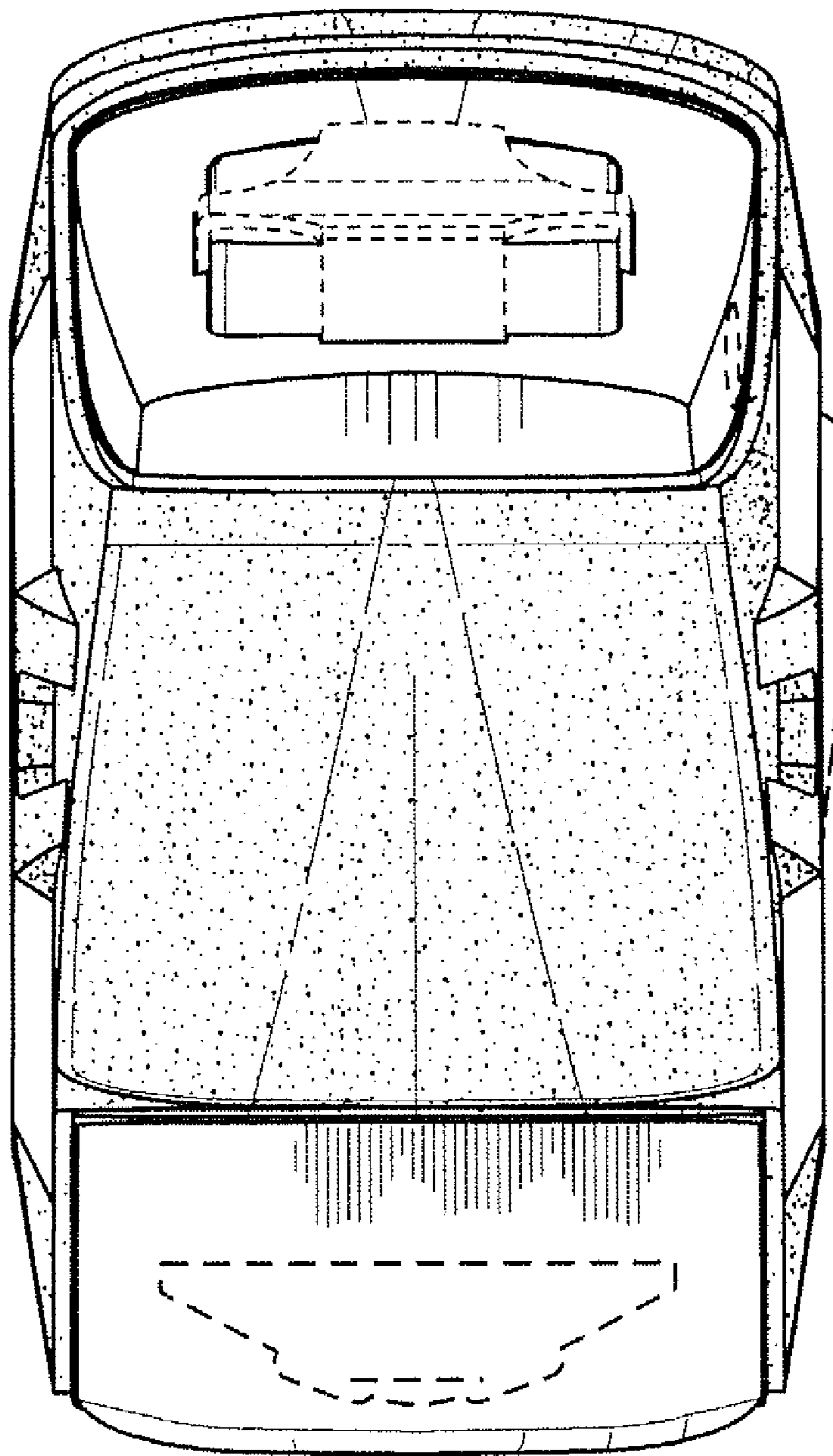
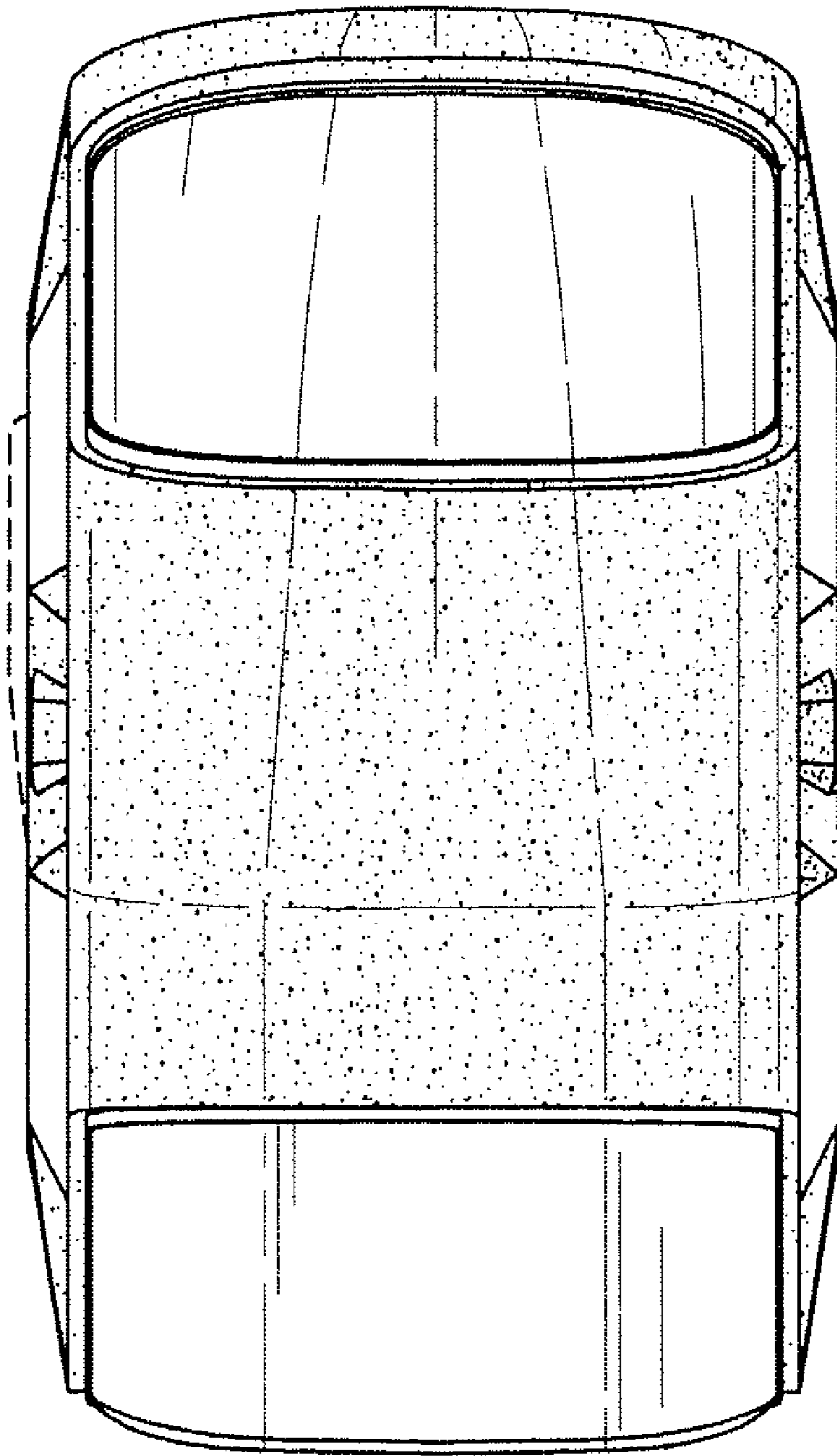


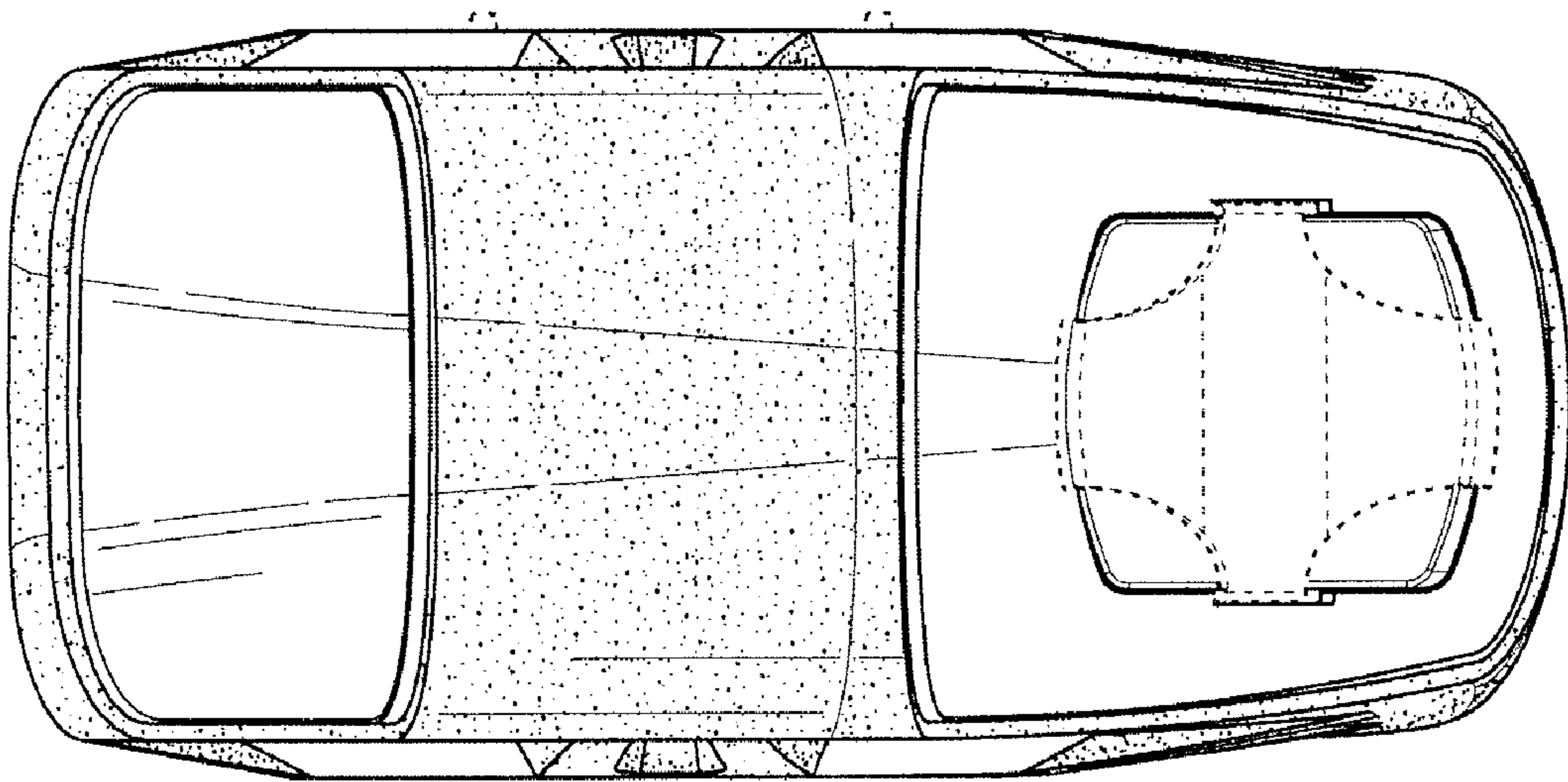
FIG. 3



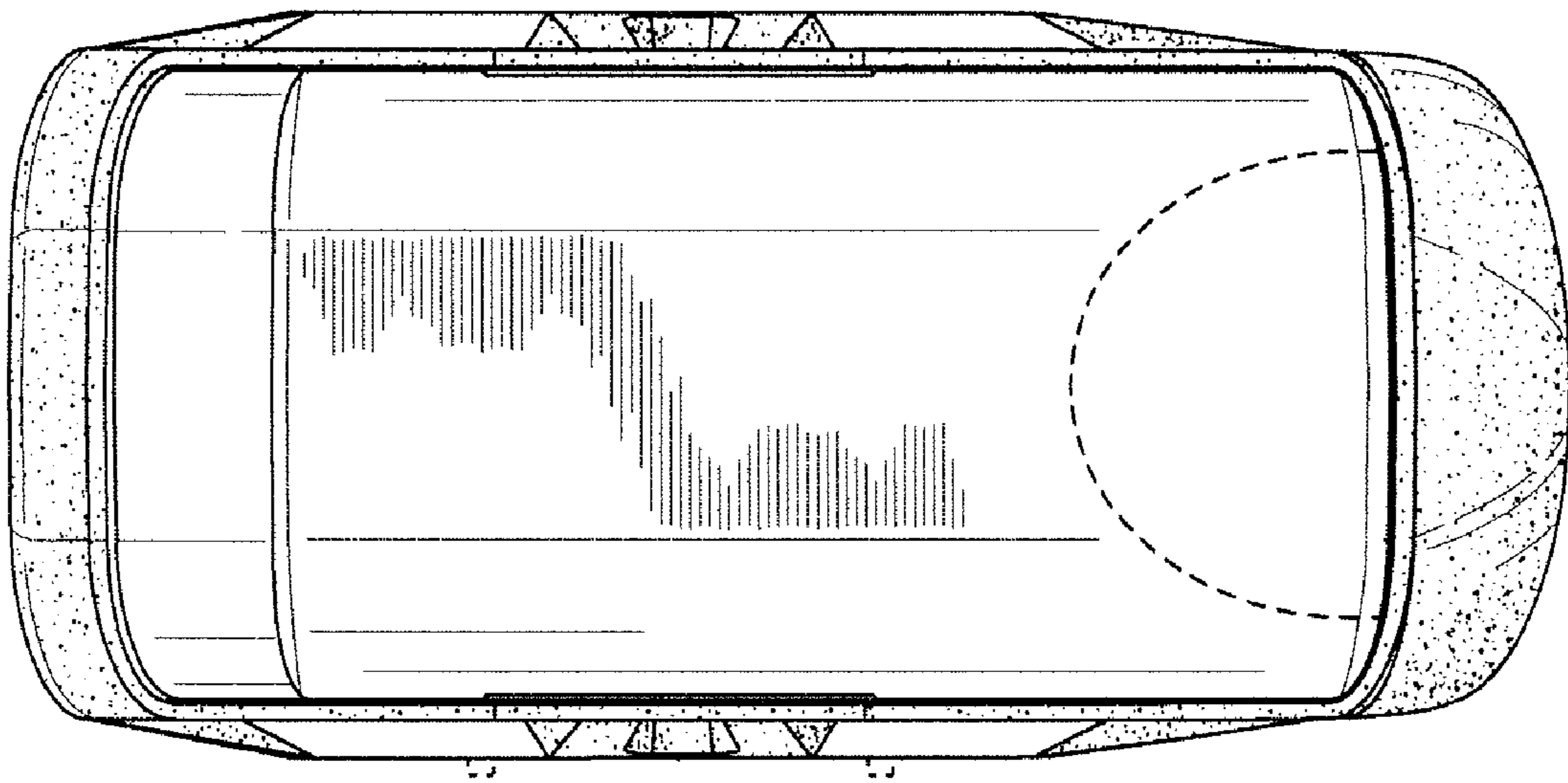
**FIG. 4**



**FIG. 5**

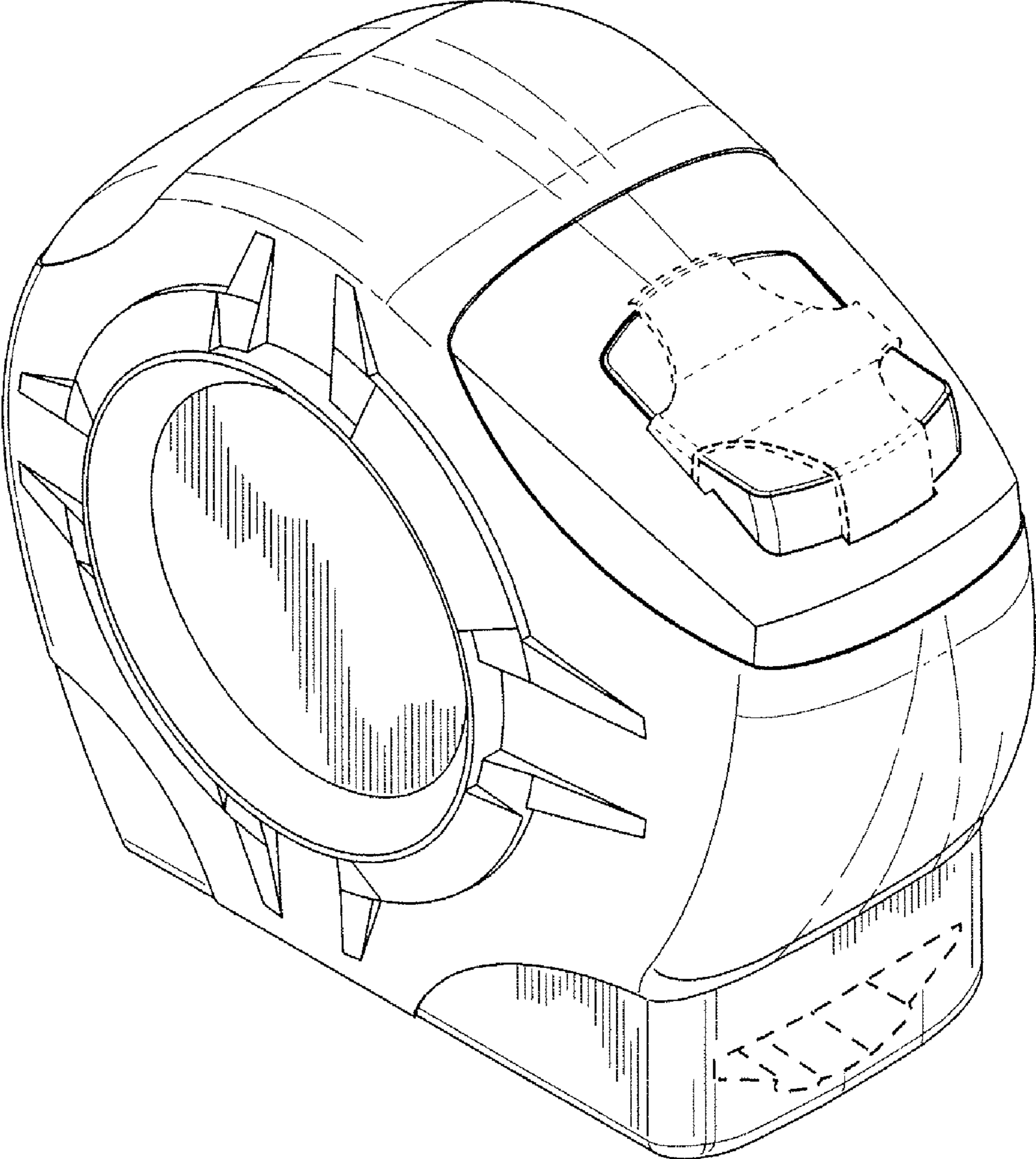


**FIG. 6**

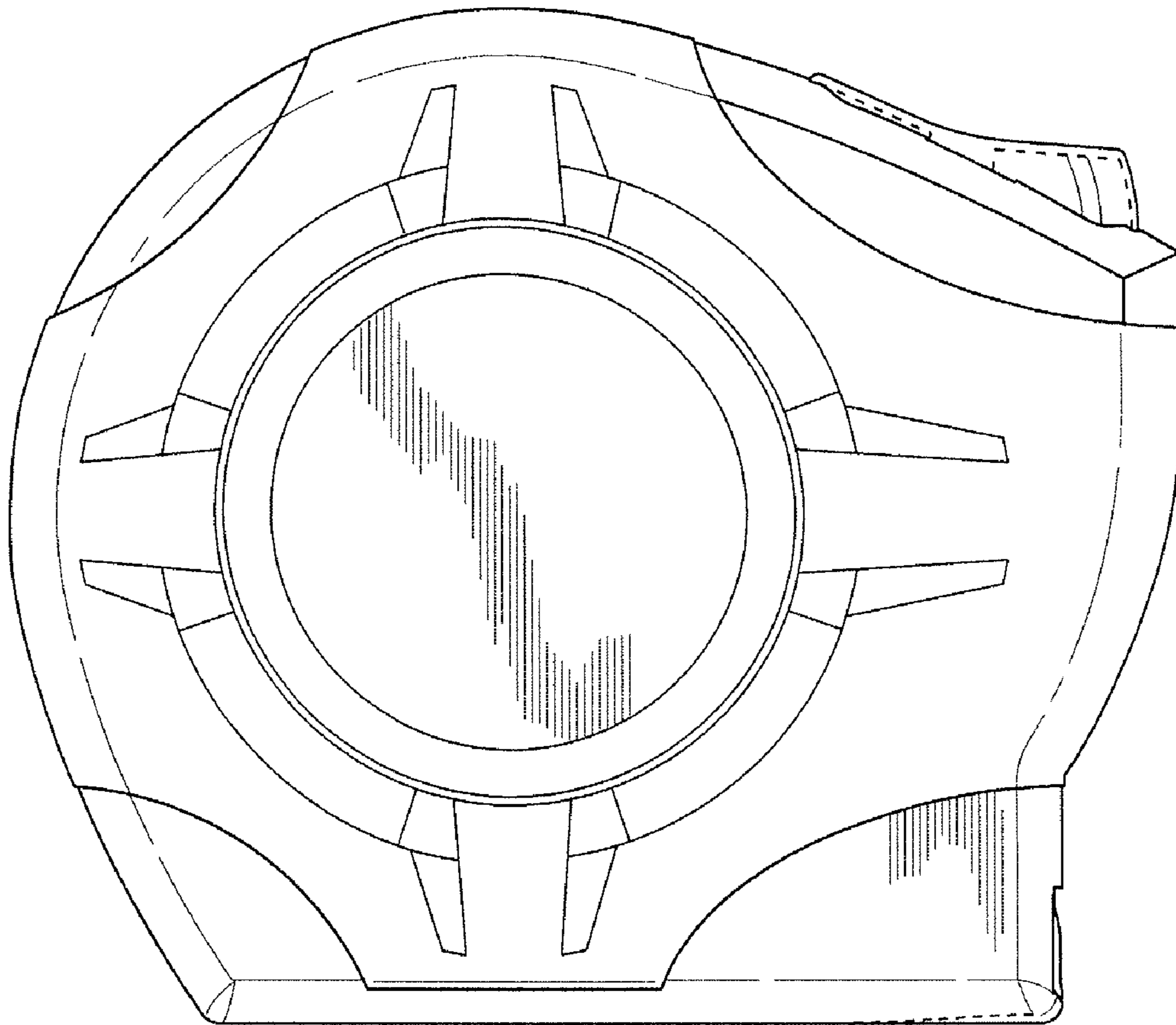


**FIG. 7**

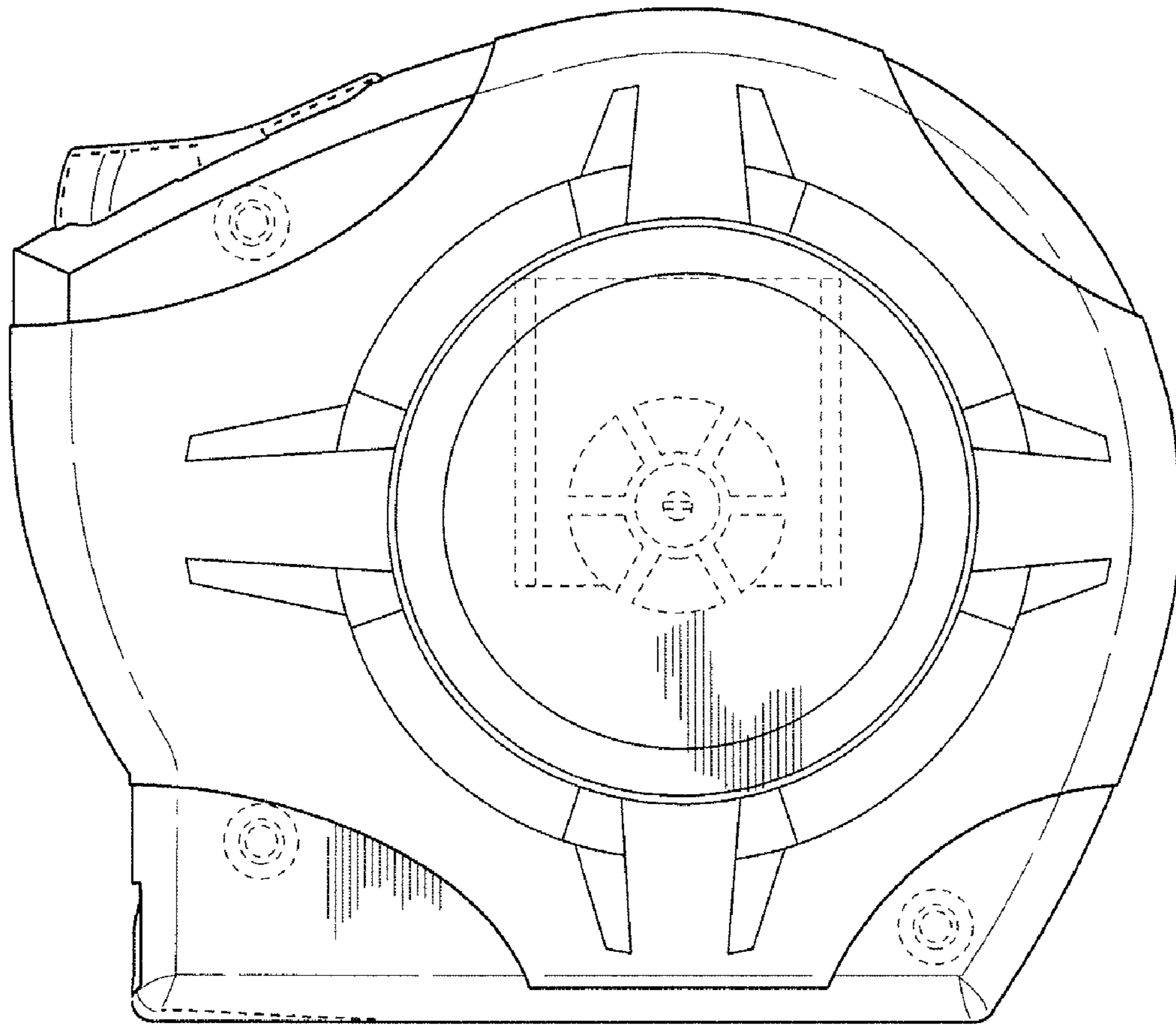




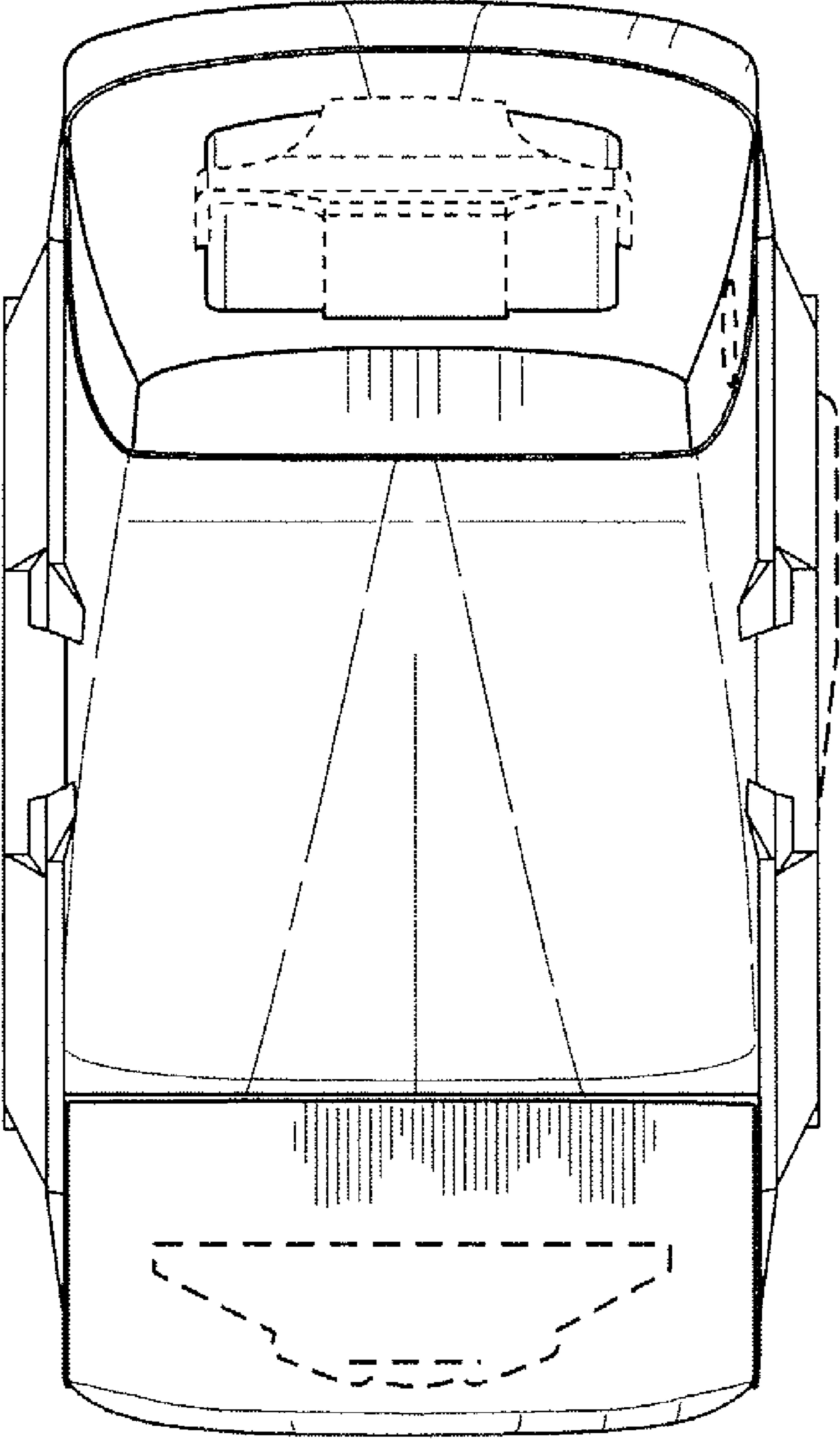
**FIG. 8**



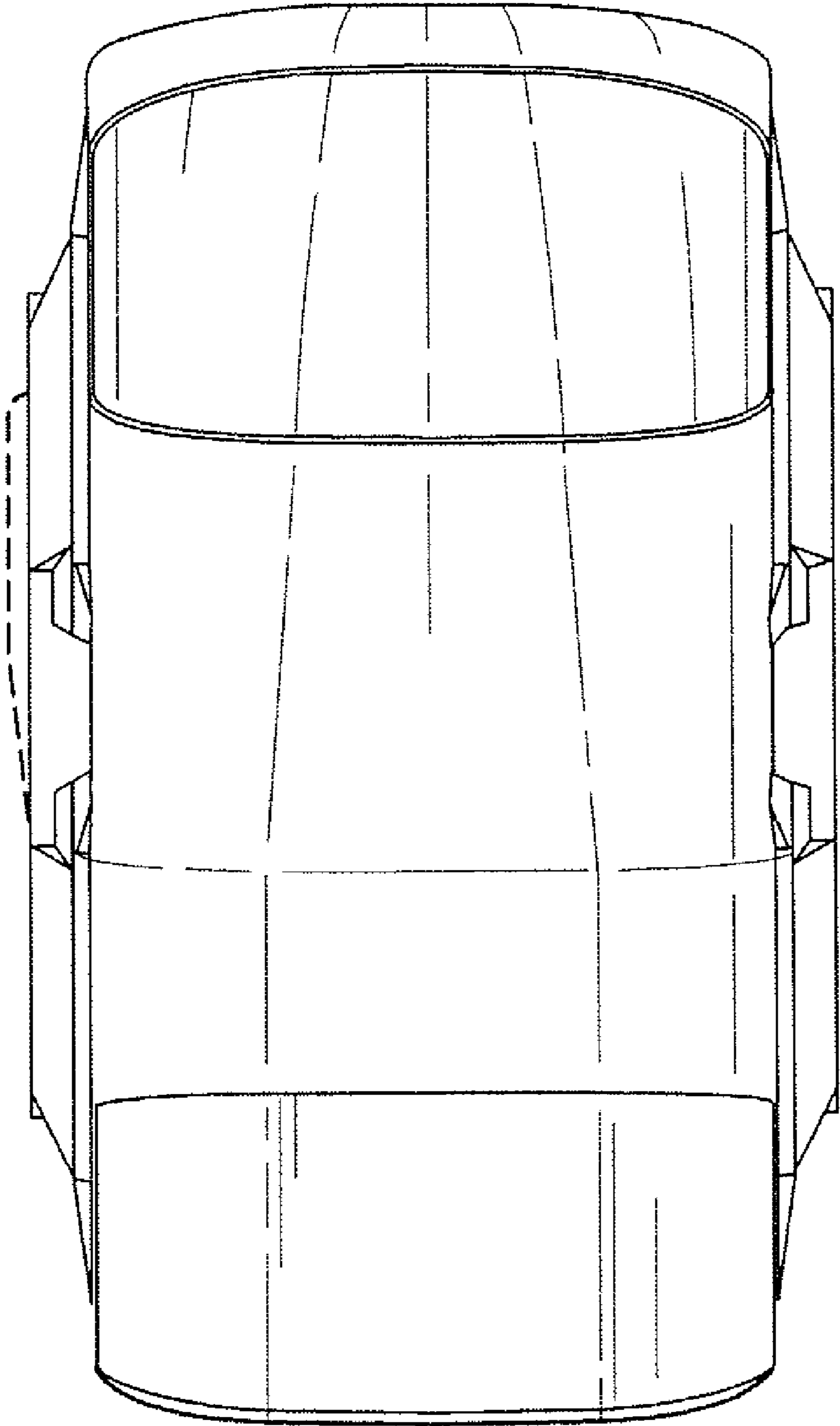
**FIG. 9**



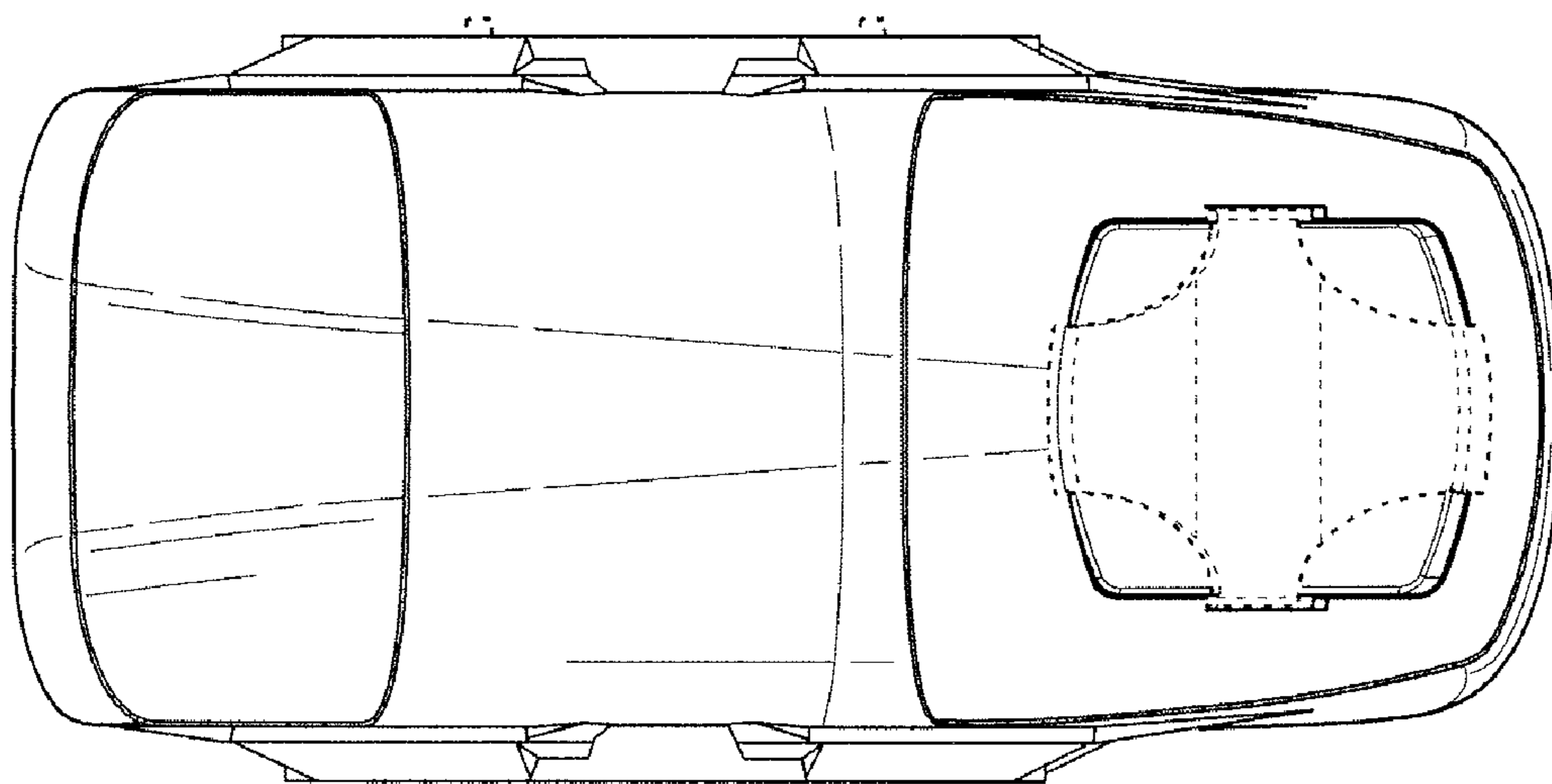
**FIG. 10**



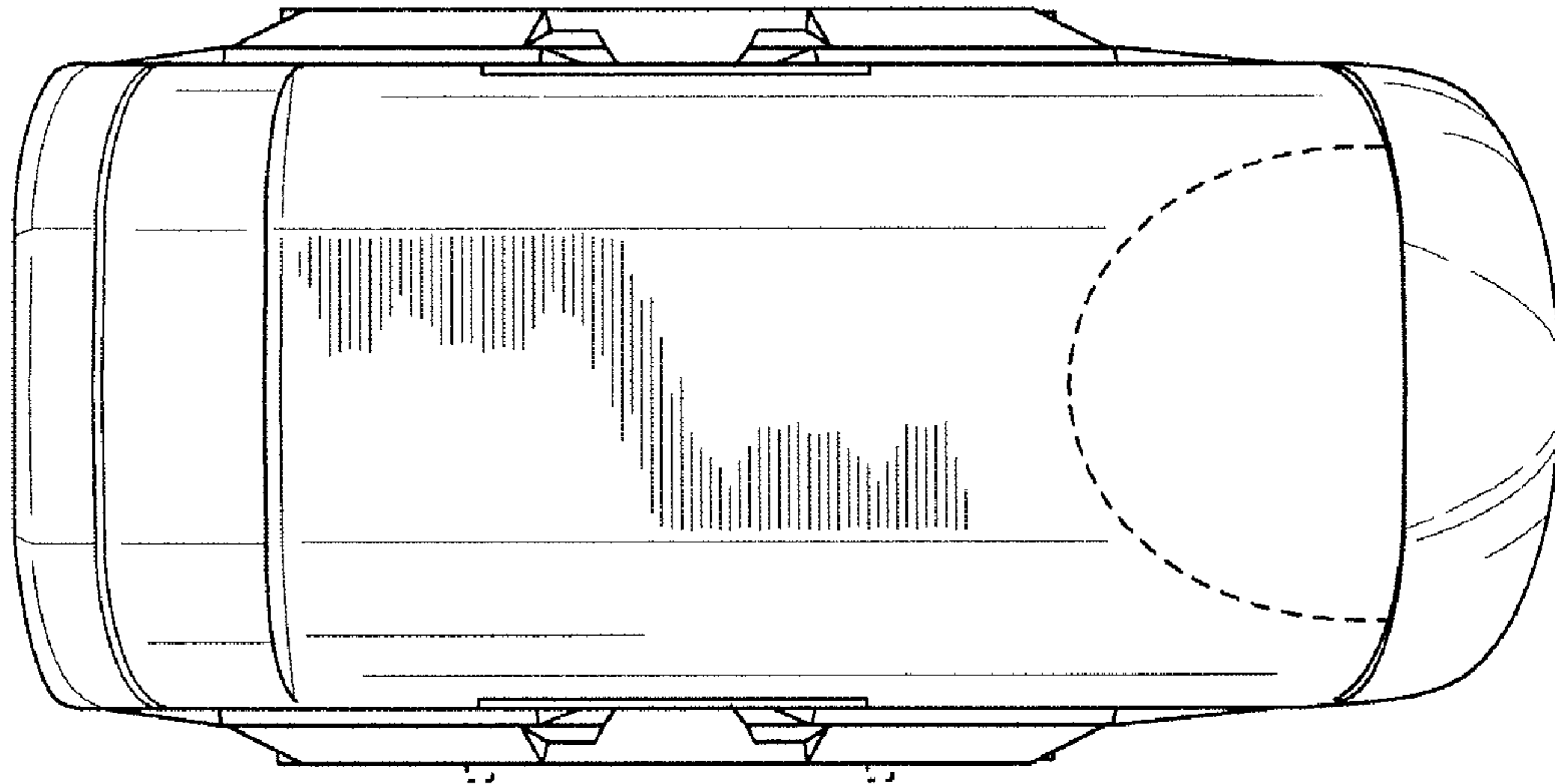
**FIG. 11**



**FIG. 12**



**FIG. 13**



**FIG. 14**