



US00D654951S

(12) **United States Design Patent**
Liang

(10) **Patent No.:** **US D654,951 S**

(45) **Date of Patent:** **** Feb. 28, 2012**

- (54) **PEN**
- (75) Inventor: **Wenyan Liang**, Ningbo (CN)
- (73) Assignee: **Beifa Group Co., Ltd.**, Ningbo (CN)
- (**) Term: **14 Years**
- (21) Appl. No.: **29/383,938**
- (22) Filed: **Jan. 24, 2011**
- (30) **Foreign Application Priority Data**

Jul. 24, 2010 (CN) 2010 3 0254451

- (51) **LOC (9) Cl.** **19-06**
- (52) **U.S. Cl.** **D19/49**
- (58) **Field of Classification Search** D19/35,
D19/36, 41-51, 54-58; D14/411, 431; 24/11 R,
24/11 F, 11 P; 401/52, 99, 100, 104-109,
401/192, 195, 196

See application file for complete search history.

(56) **References Cited**

U.S. PATENT DOCUMENTS

D100,380 S	7/1936	Lynn	
D110,810 S	8/1938	Kahn	
D120,137 S *	4/1940	Most	D19/48
D189,735 S *	2/1961	Platt	D19/50
D321,207 S	10/1991	Granoff	
D354,985 S	1/1995	Hong	
D357,700 S *	4/1995	Oka	D19/55
D371,388 S *	7/1996	Ito et al.	D19/49
D441,018 S	4/2001	Droege	
D465,238 S *	11/2002	Qiu	D19/50

D491,224 S	6/2004	Hsieh	
D496,963 S	10/2004	Loesel	
D499,447 S	12/2004	Hui-Kuo	
D501,508 S	2/2005	Lecce	
D502,507 S *	3/2005	Wang	D19/50
D534,958 S	1/2007	Nishida	
D536,033 S *	1/2007	Lecce	D19/50
D538,341 S	3/2007	Oas	
D549,778 S *	8/2007	Kent et al.	D19/51
D561,254 S *	2/2008	Lin	D19/48
D566,763 S *	4/2008	Kowalczyk	D19/50
D571,400 S	6/2008	Anand	
D573,185 S *	7/2008	Qiu et al.	D19/51
D576,676 S *	9/2008	Shimizu	D19/49
D577,069 S	9/2008	Bhavnani	
D599,403 S *	9/2009	Wang	D19/48

* cited by examiner

Primary Examiner — Elizabeth Albert

(74) *Attorney, Agent, or Firm* — Christensen O'Connor Johnson Kindness PLLC

(57) **CLAIM**

The ornamental design for a pen, as shown and described.

DESCRIPTION

FIG. 1 is a lower front right perspective view of a pen showing my new design;

FIG. 2 is a right side elevation view thereof, with the left side elevation view being a mirror image of the right side elevation view;

FIG. 3 is a front elevation view thereof;

FIG. 4 is a rear elevation view thereof;

FIG. 5 is an enlarged top plan view thereof; and,

FIG. 6 is an enlarged bottom plan view thereof.

1 Claim, 3 Drawing Sheets

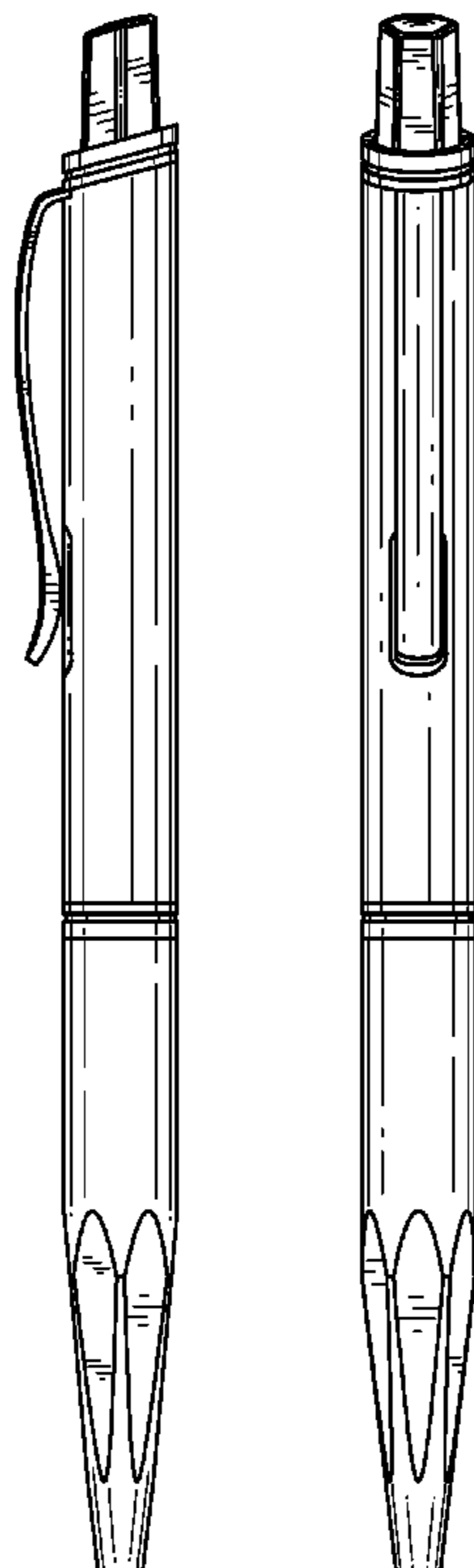

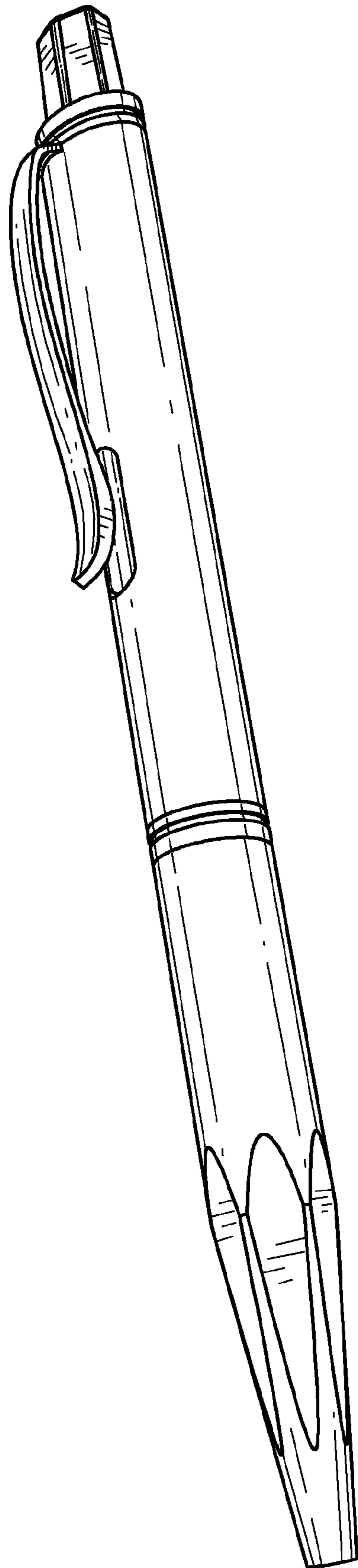

Fig.1.

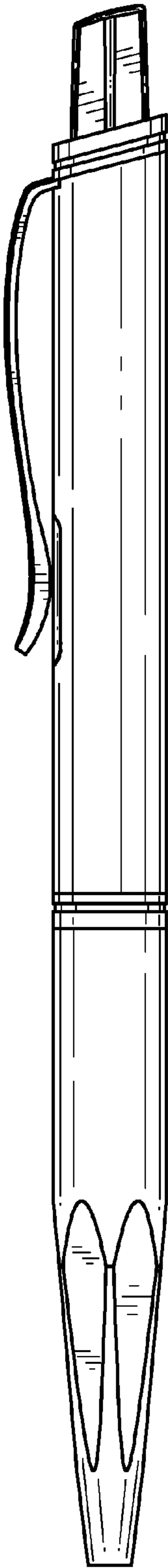

Fig. 2.

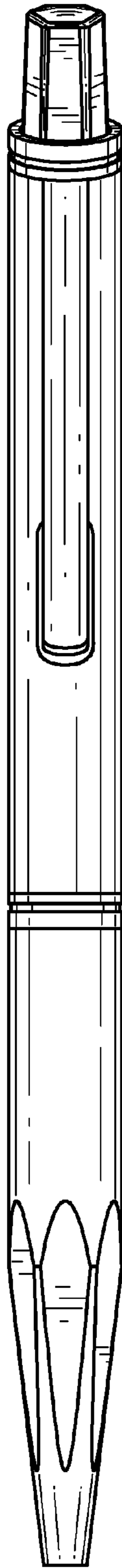

Fig. 3.

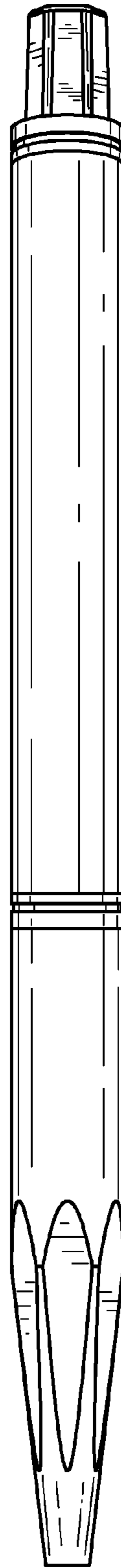

Fig. 4.

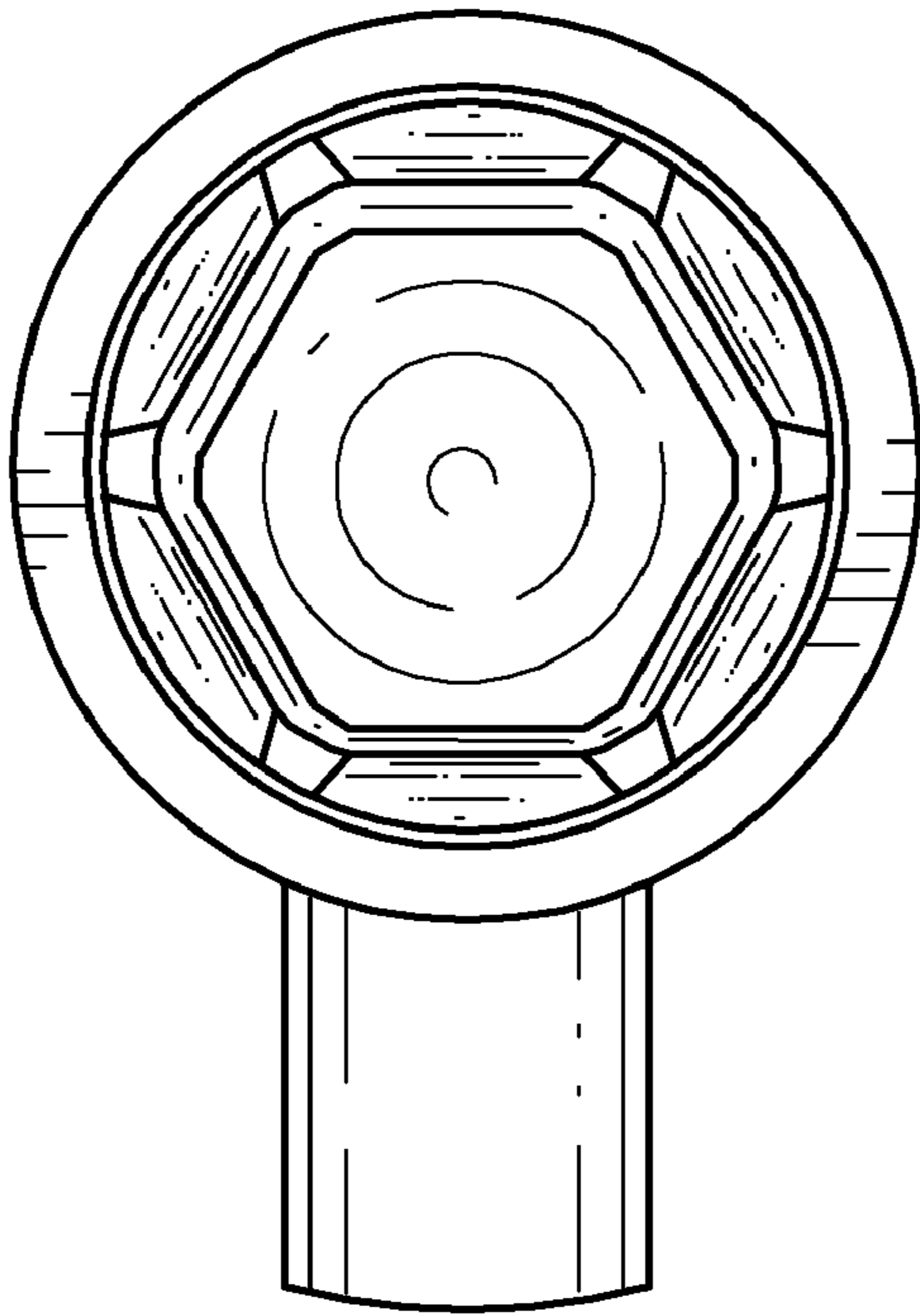

Fig. 5.

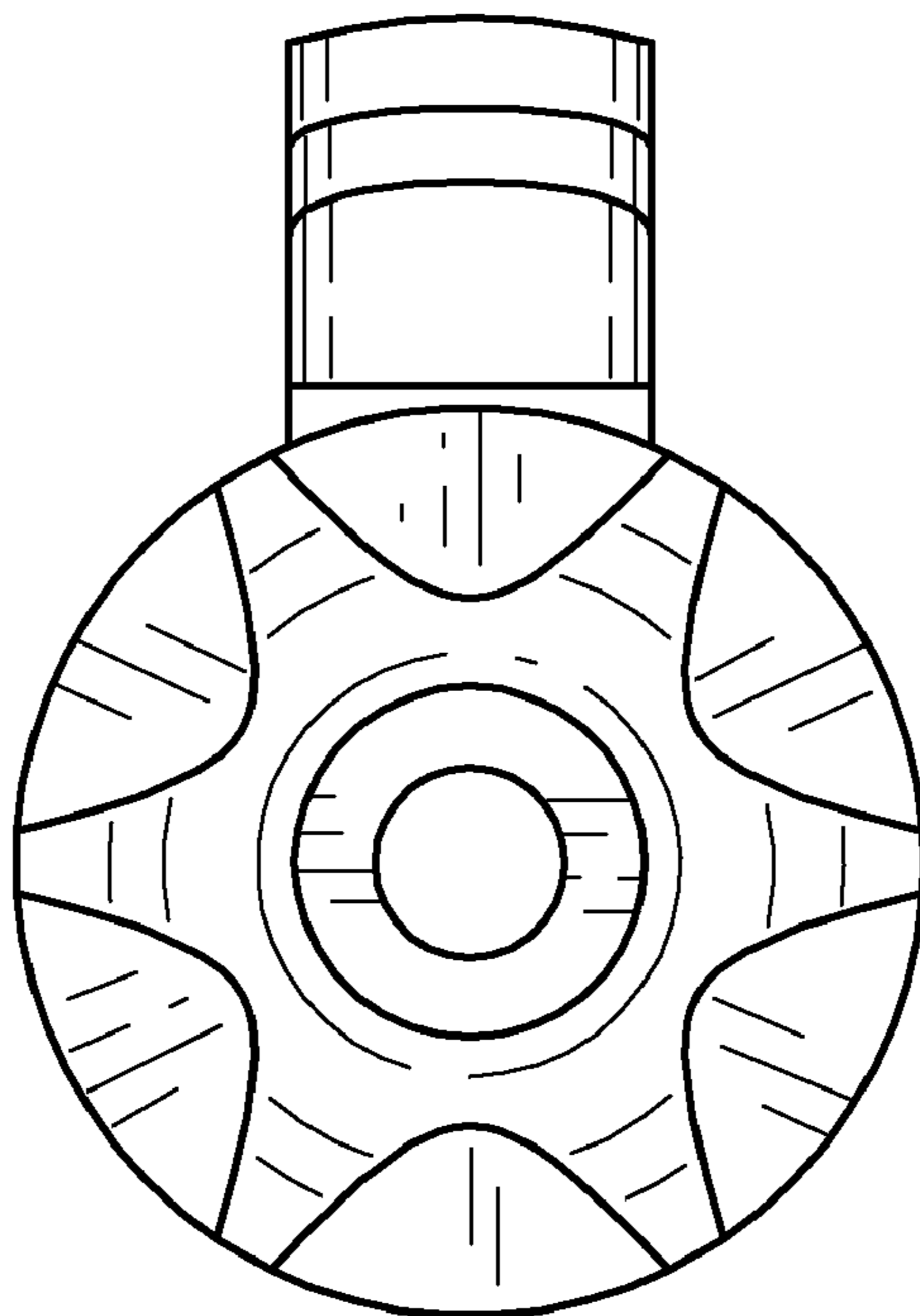

Fig. 6.