

US00D654945S

(12) **United States Design Patent**
Giammarinaro, Jr.

(10) **Patent No.:** **US D654,945 S**

(45) **Date of Patent:** **** Feb. 28, 2012**

(54) **INFLATABLE PROJECTION SCREEN**

D634,722 S 3/2011 Kim et al.
7,920,326 B2 * 4/2011 Clawson et al. 359/443
7,942,533 B2 5/2011 Ganzevoort
7,961,388 B1 * 6/2011 Deutsch et al. 359/443

(76) **Inventor:** **Richard Giammarinaro, Jr.**, Fallbrook,
CA (US)

(**) **Term:** **14 Years**

(21) **Appl. No.:** **29/390,545**

(22) **Filed:** **Apr. 26, 2011**

(51) **LOC (9) Cl.** **16-05**

(52) **U.S. Cl.** **D16/241**

(58) **Field of Classification Search** D16/235,
D16/241; 160/24, 38, 39; 359/443, 444;
396/3, 4

See application file for complete search history.

(56) **References Cited**

U.S. PATENT DOCUMENTS

D219,408 S	12/1970	Frish	
4,323,301 A	4/1982	Spector	
4,339,175 A	7/1982	Astero	
4,369,591 A	1/1983	Vicino	
5,471,797 A *	12/1995	Murphy	52/2.17
5,548,356 A *	8/1996	Portman	359/443
6,008,938 A	12/1999	Suehle et al.	
D481,437 S	10/2003	Peterson	
6,668,475 B2	12/2003	Carolan	
D543,229 S	5/2007	Hochendoner	
7,446,937 B2	11/2008	Poretskin	
D593,591 S	6/2009	Hochendoner et al.	
D596,219 S *	7/2009	Tatara et al.	D16/241
D629,484 S	12/2010	Jackson	

OTHER PUBLICATIONS

Photos/Images in 4 pages of Inflatable Outdoor Movie Screen, Inflatable Superstore, first published Jul. 2009.

* cited by examiner

Primary Examiner — Adir Aronovich

(74) *Attorney, Agent, or Firm* — Porcopio, Cory, Hargreaves & Savitch LLP

(57) **CLAIM**

The ornamental design for an inflatable projection screen, as shown and described.

DESCRIPTION

FIG. 1 is a front perspective view of an inflatable projection screen, showing my new design;
FIG. 2 is a front elevation view thereof;
FIG. 3 is a rear elevation view thereof;
FIG. 4 is a right side elevation view thereof, the left side elevation view being a mirror image thereof;
FIG. 5 is a top plan view thereof; and,
FIG. 6 is a rear perspective view thereof.

1 Claim, 5 Drawing Sheets

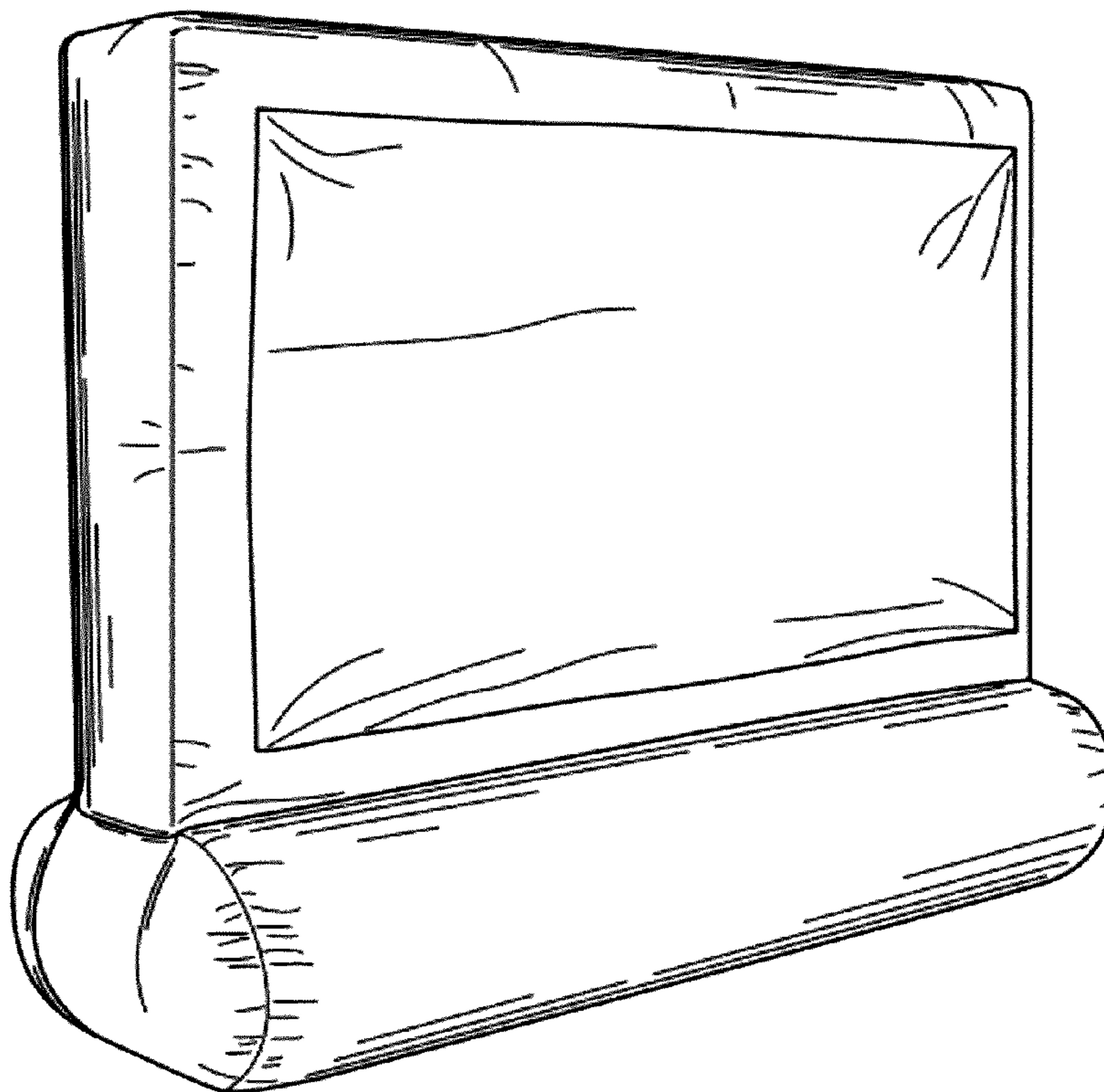

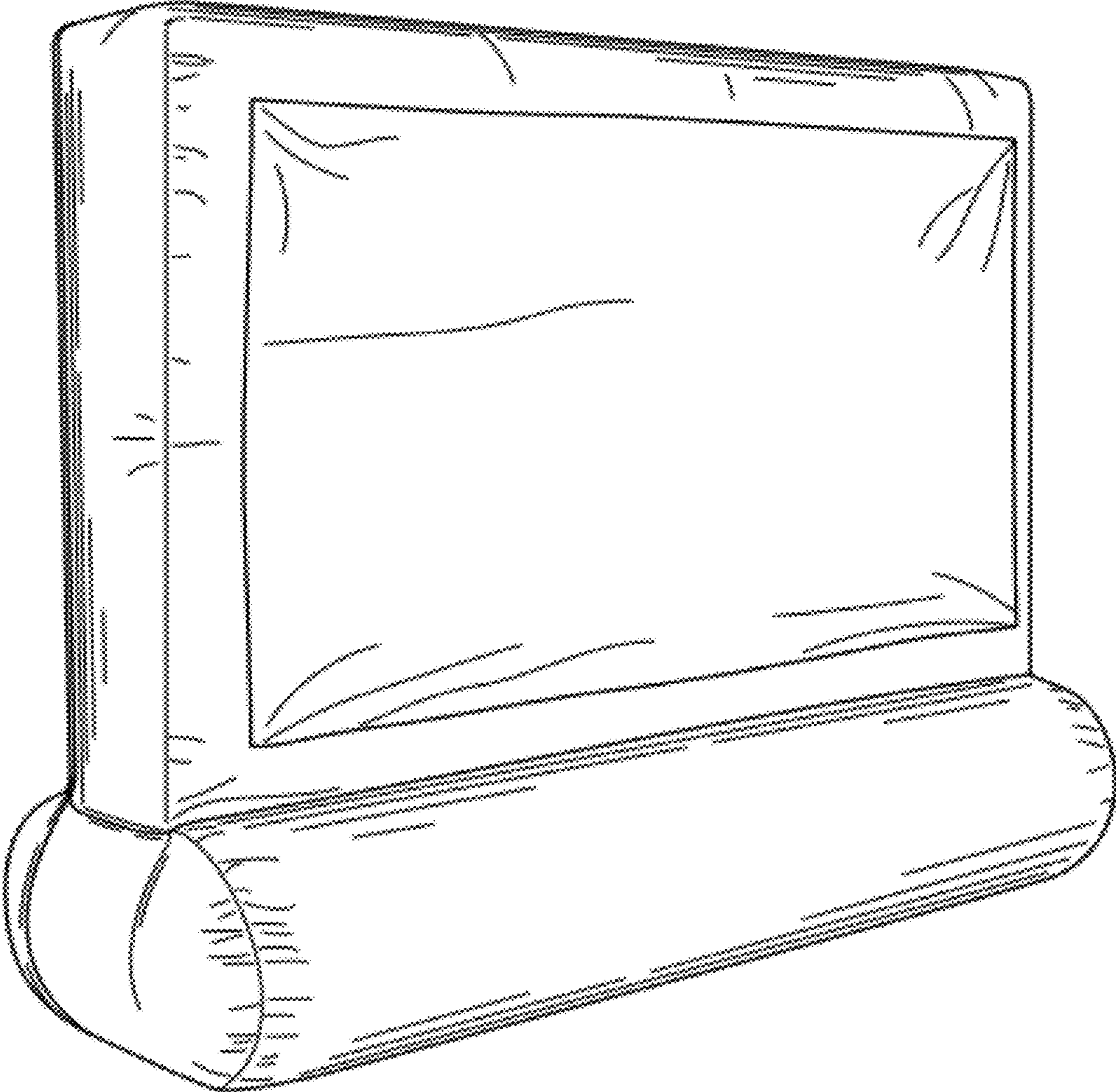

FIG. 1

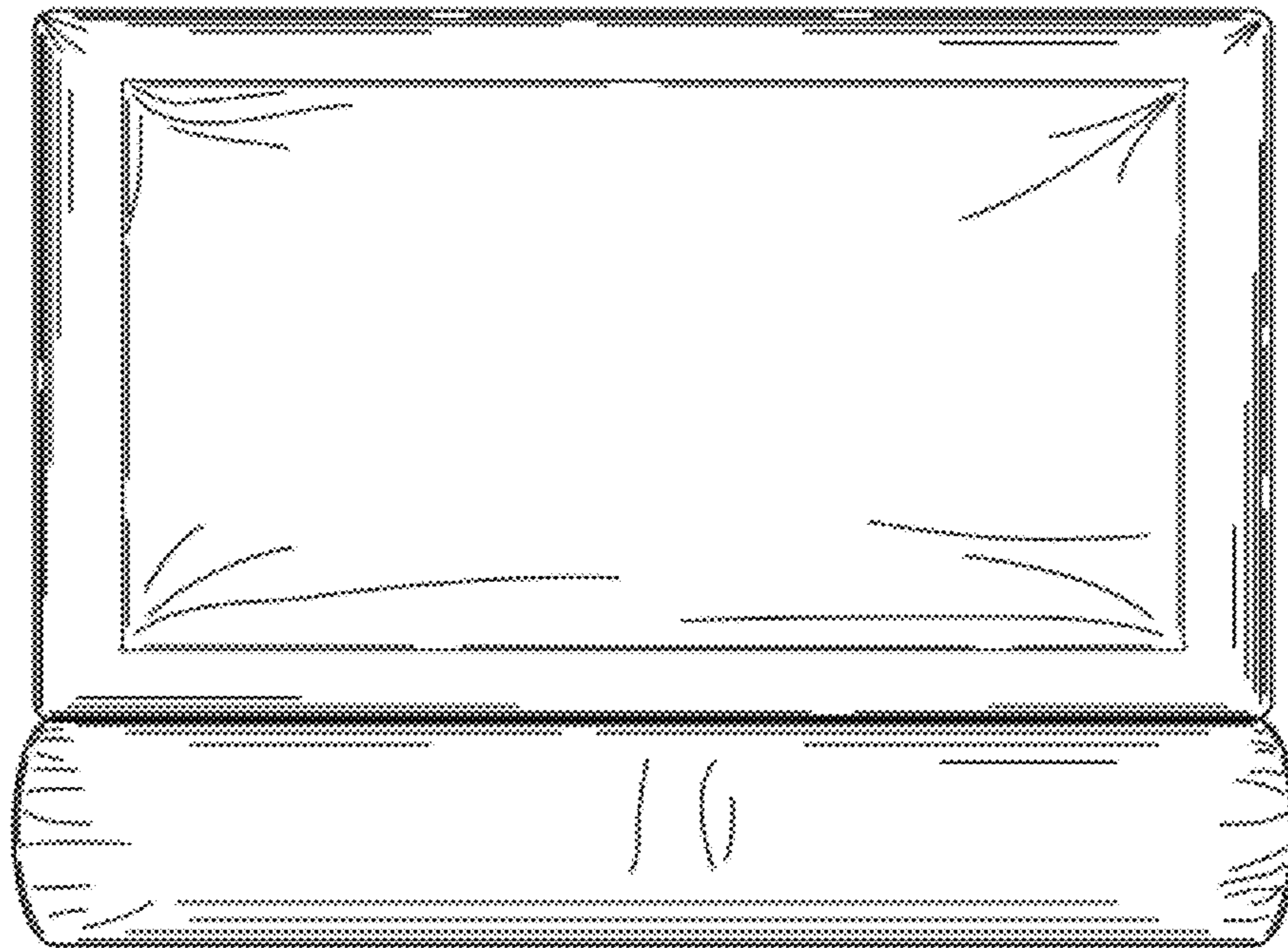

FIG. 2

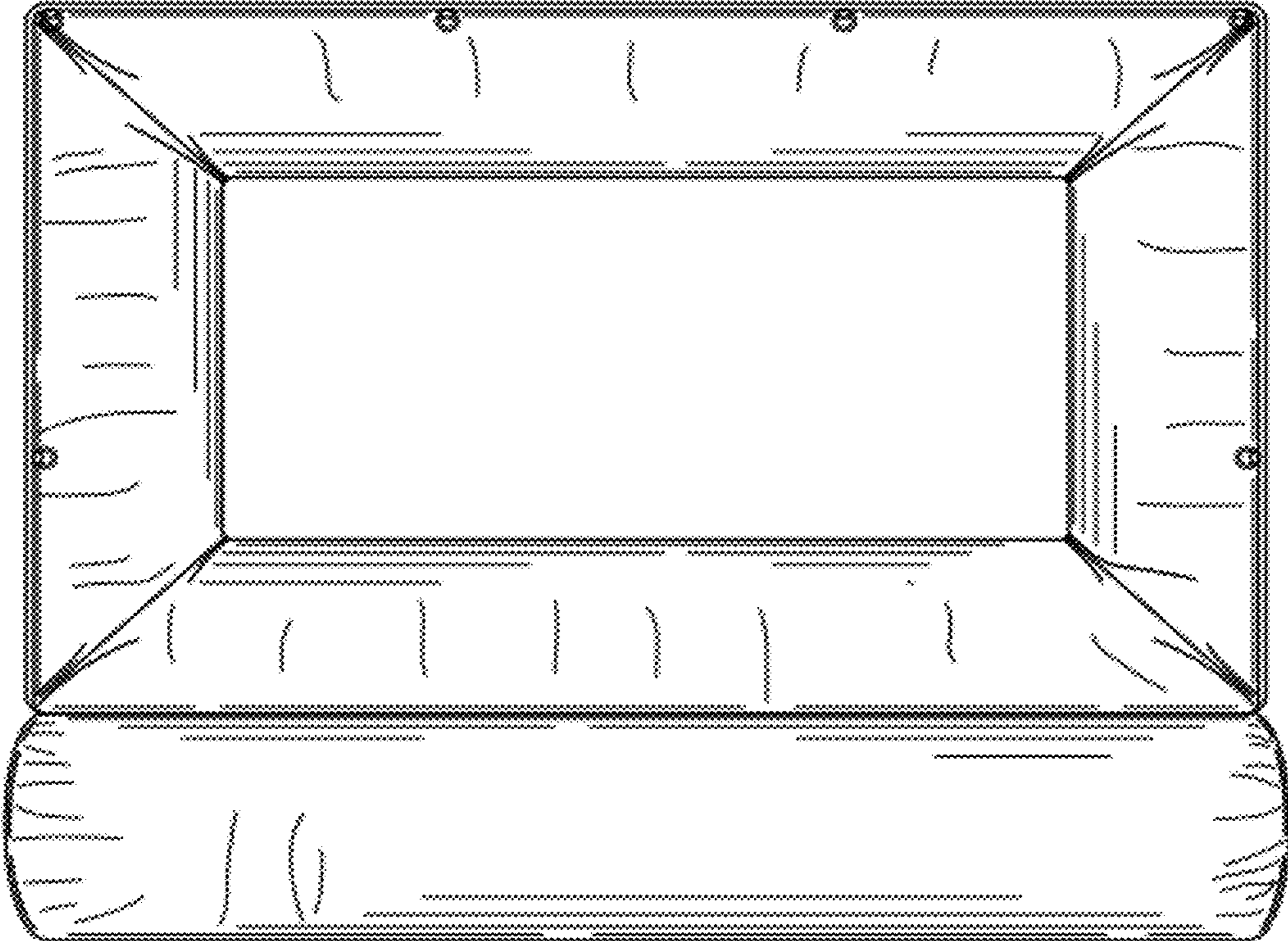

FIG. 3

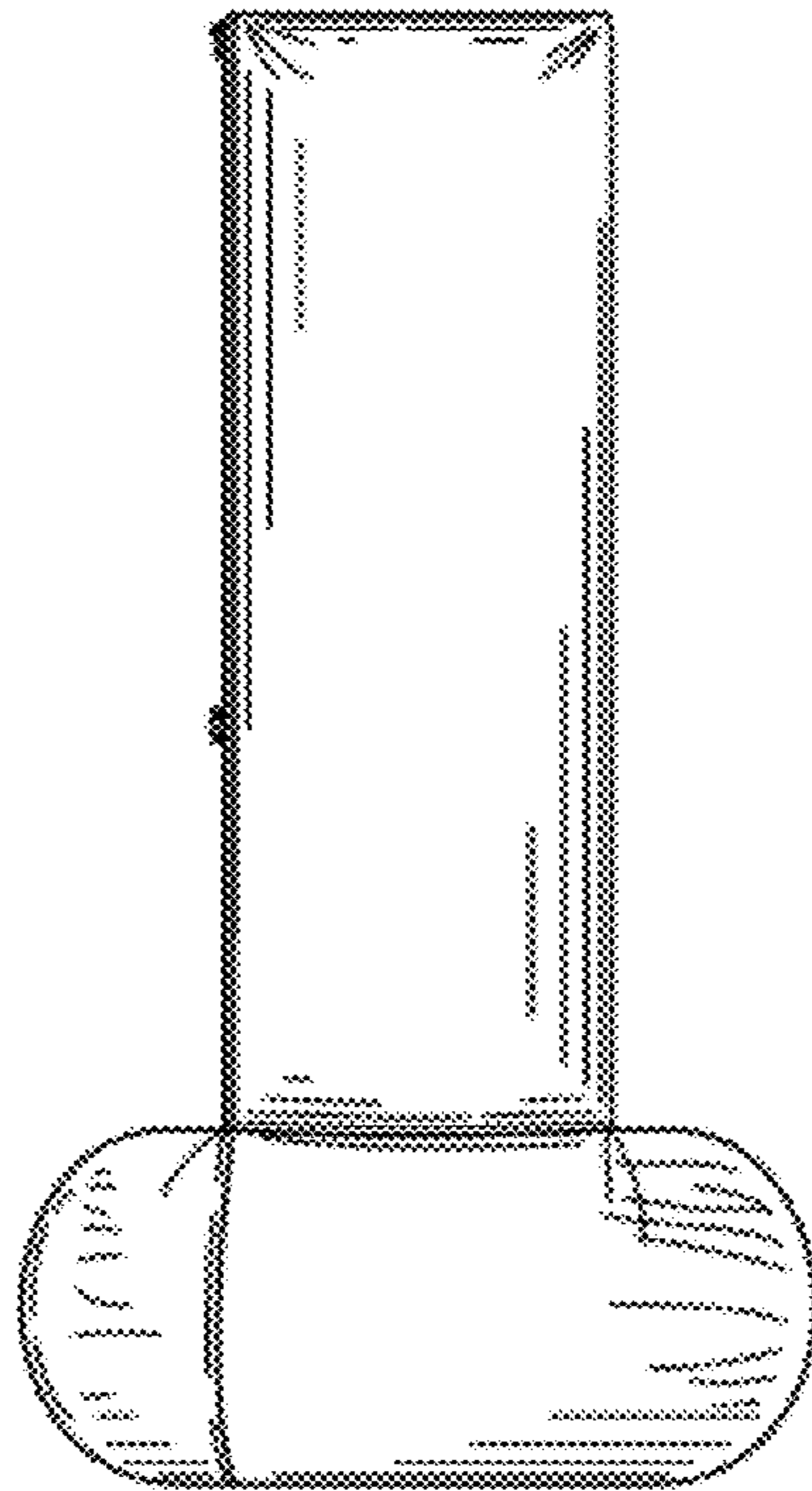

FIG. 4

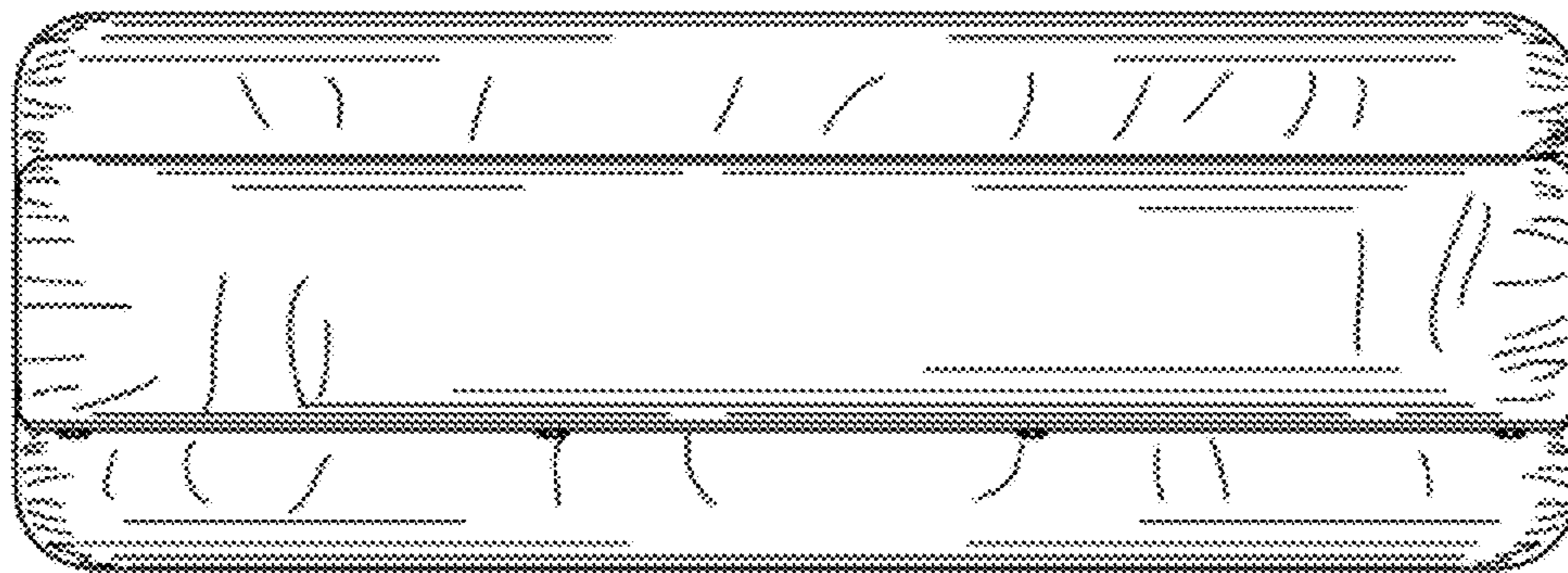

FIG. 5

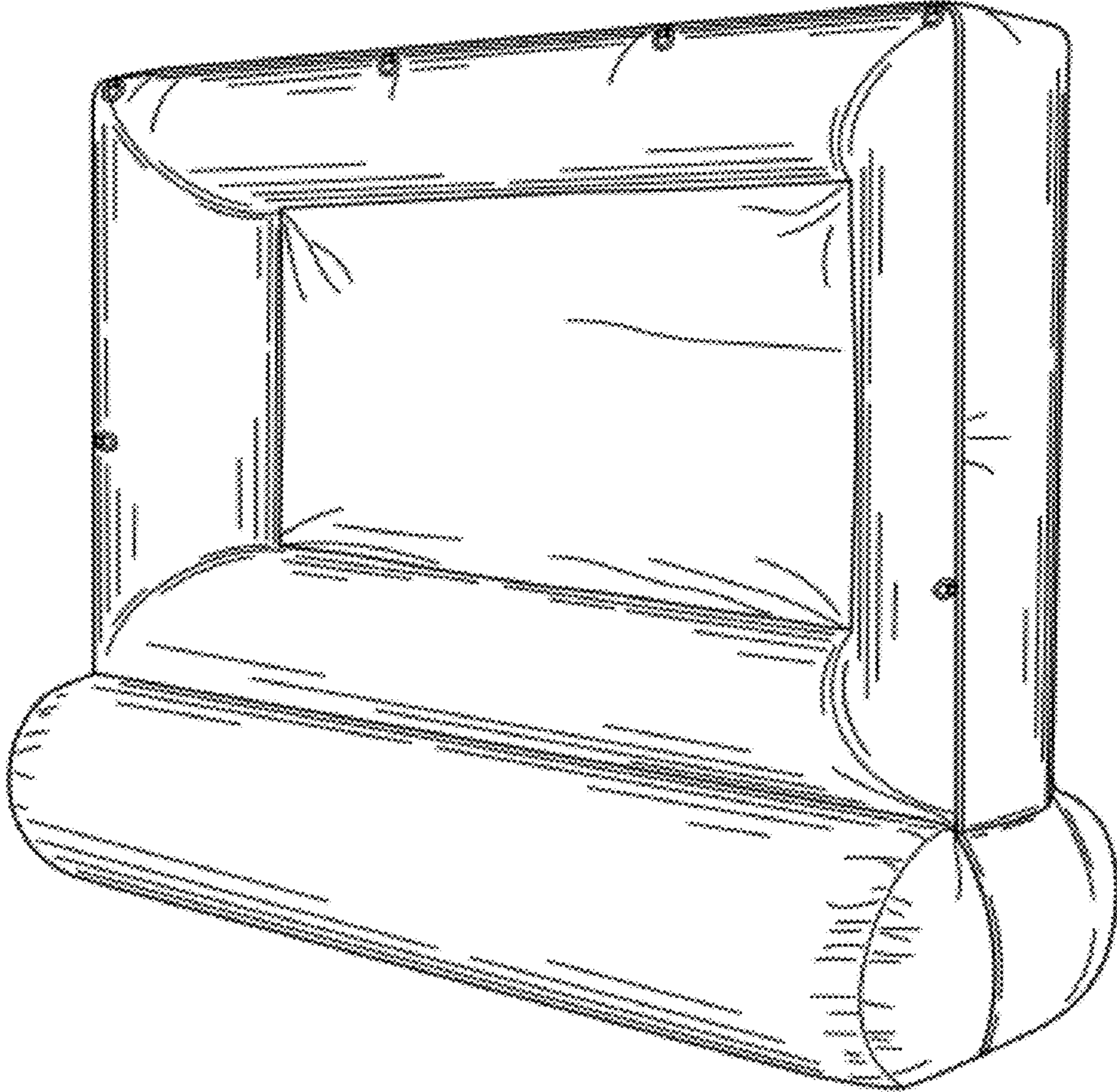

FIG. 6