



US00D654707S

(12) **United States Design Patent**
Gouldson

(10) **Patent No.:** **US D654,707 S**

(45) **Date of Patent:** **** Feb. 28, 2012**

(54) **TOP GARMENT HANGER WITH INDICATOR AND PLACARD**

Primary Examiner — Prabhakar Deshmukh

(74) *Attorney, Agent, or Firm* — Scully, Scott, Murphy & Presser, P.C.

(75) Inventor: **Stanley F. Gouldson**, Northport, NY (US)

(73) Assignee: **Spotless Plastics Pty. Ltd.**, Melbourne, Victoria (AU)

(57) **CLAIM**

The ornamental design for a top garment hanger with indicator and placard, as shown and described.

(**) Term: **14 Years**

(21) Appl. No.: **29/380,075**

DESCRIPTION

(22) Filed: **Nov. 30, 2010**

(51) **LOC (9) Cl.** **06-07**

(52) **U.S. Cl.** **D6/326**

(58) **Field of Classification Search** D6/315–328; 223/85–98; 211/1, 13.1, 85.3

See application file for complete search history.

FIG. 1 is a perspective view of a top garment hanger with indicator and placard showing my new design;

FIG. 2 is a front view thereof;

FIG. 3 is a rear view thereof;

FIG. 4 is a top view thereof;

FIG. 5 is a bottom view thereof;

FIG. 6 is a side view thereof;

FIG. 7 is an opposite side view thereof;

FIG. 8 is a perspective view of a top garment hanger with indicator and placard showing another embodiment of my new and ornamental design;

FIG. 9 is a front view thereof;

FIG. 10 is a rear view thereof;

FIG. 11 is a top view thereof;

FIG. 12 is a bottom view thereof;

FIG. 13 is a side view thereof; and,

FIG. 14 is an opposite side view thereof.

The broken line showing of the hanger and lettering is for the purpose of illustrating environmental structure and forms no part of the claimed design.

(56) **References Cited**

U.S. PATENT DOCUMENTS

4,382,531	A *	5/1983	Bisk et al.	223/91
4,653,678	A *	3/1987	Blanchard et al.	223/85
4,714,183	A *	12/1987	Tontarelli	223/91
6,070,772	A *	6/2000	Bond	223/85
6,105,834	A *	8/2000	Cohen	223/88
6,308,872	B1 *	10/2001	Duerr et al.	223/88
6,467,658	B1 *	10/2002	Olk et al.	223/88
6,758,379	B1 *	7/2004	Elwell	223/85
D501,094	S *	1/2005	Hendricks	D6/326
D521,254	S *	5/2006	Biu	D6/319
D531,824	S *	11/2006	Yau	D6/328
D597,749	S *	8/2009	Heroux	D6/319
D606,767	S *	12/2009	Warren	D6/319

* cited by examiner

1 Claim, 10 Drawing Sheets

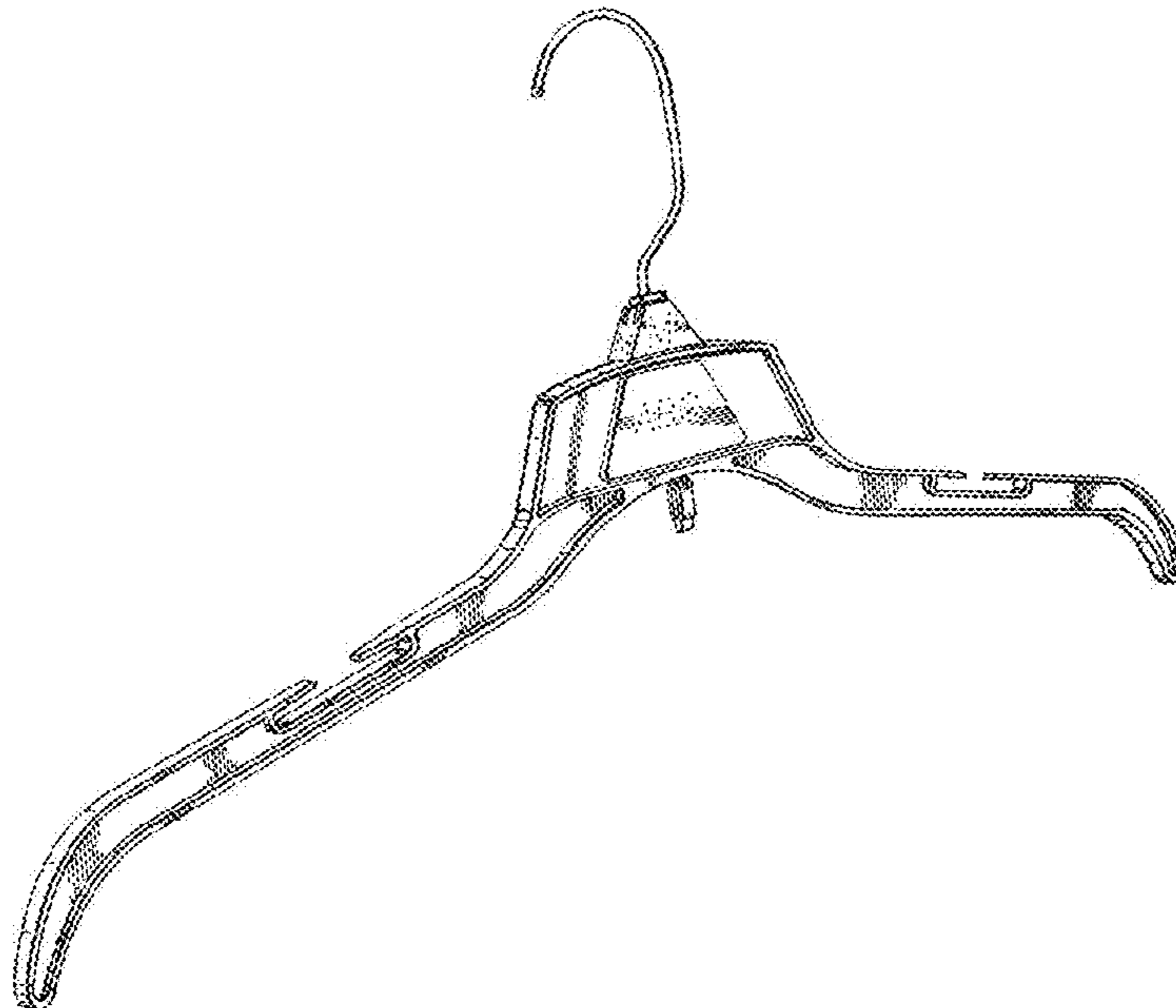

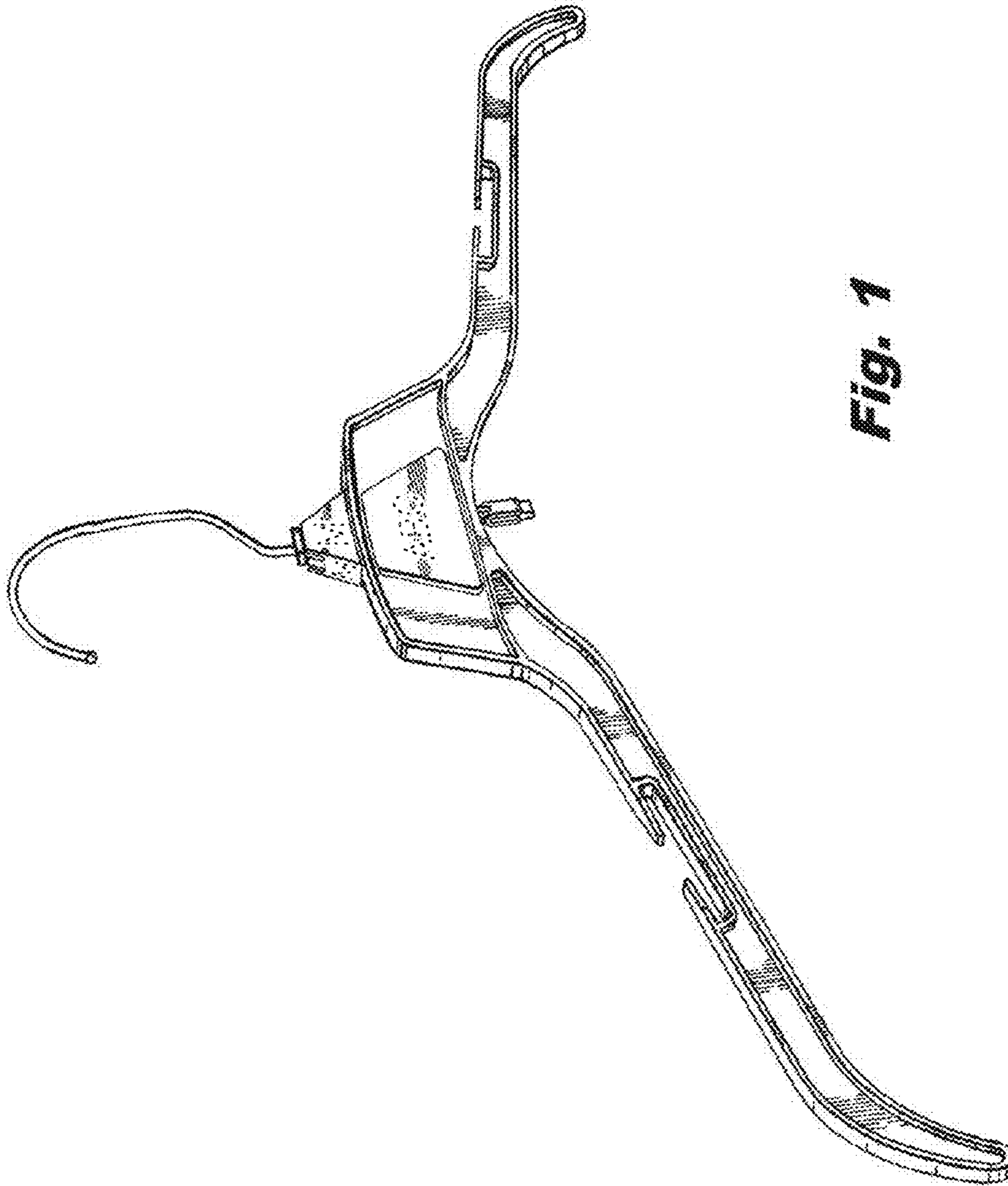

Fig. 1

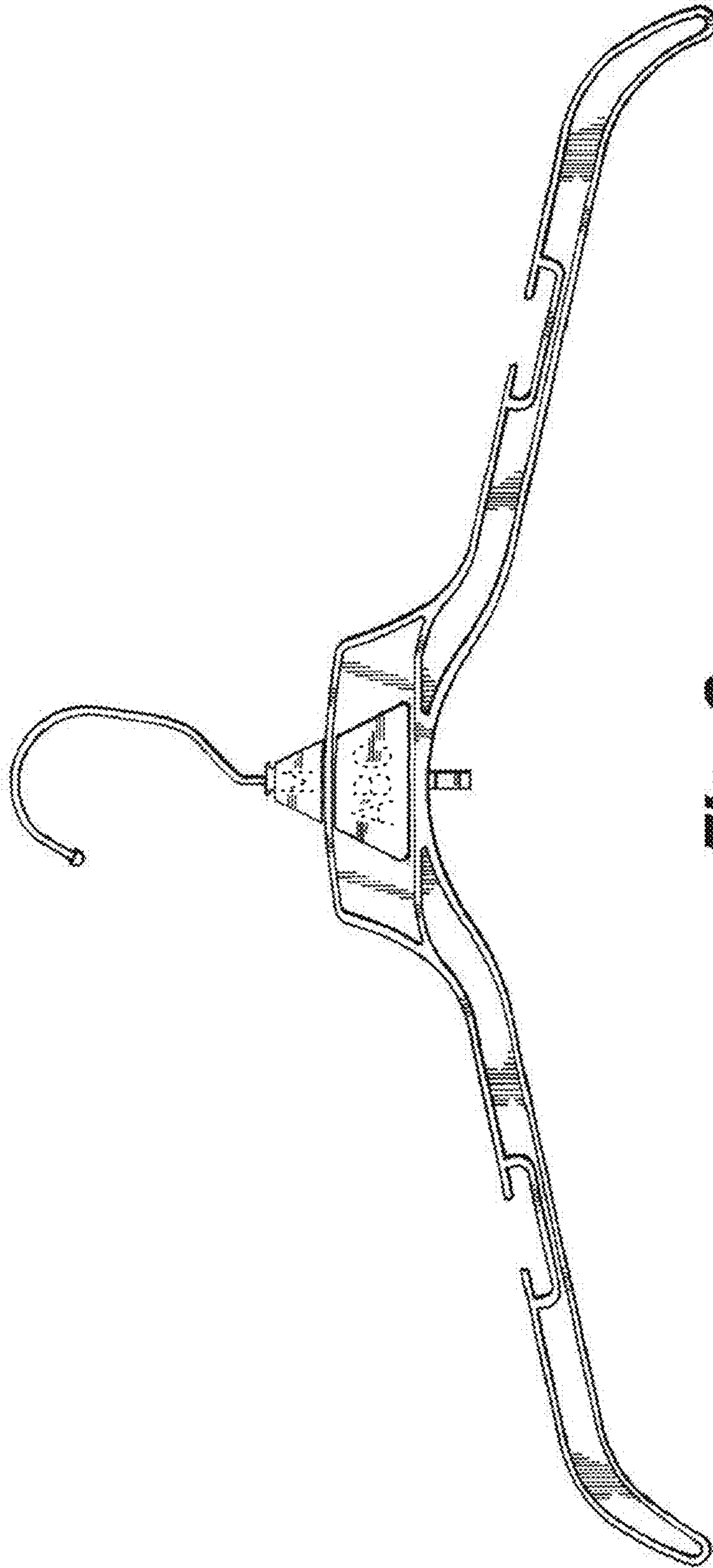

Fig. 2

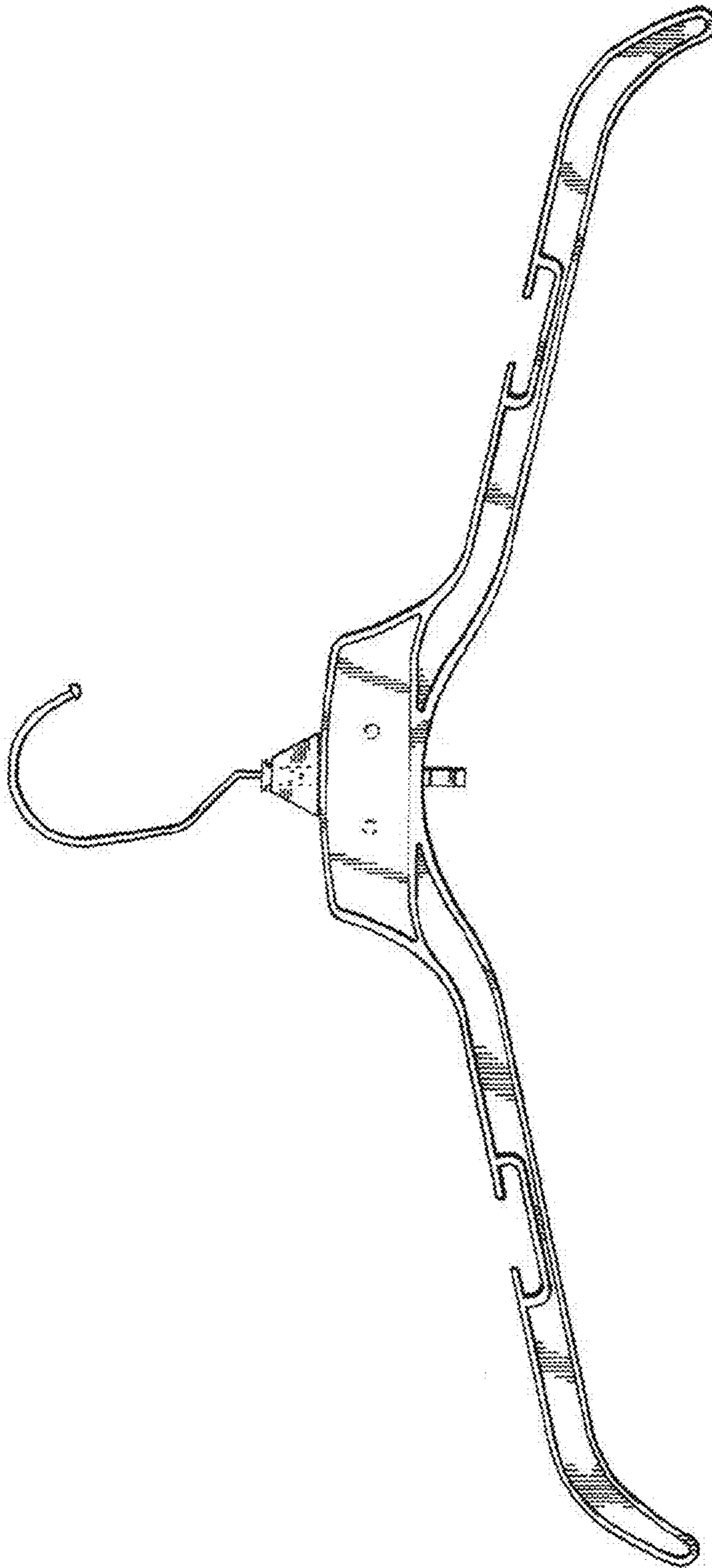

Fig. 3

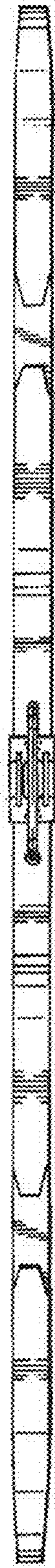

Fig. 4



Fig. 5

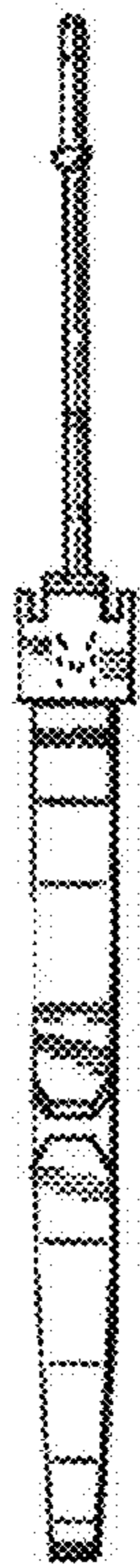

Fig. 6

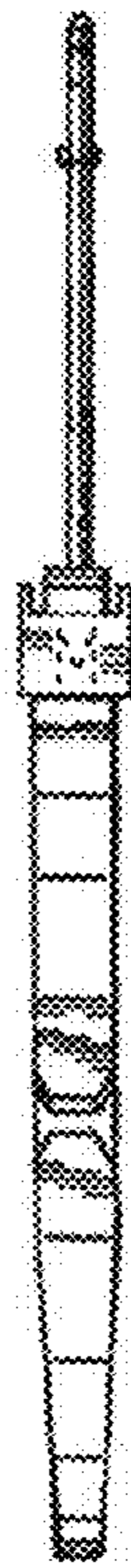

Fig. 7

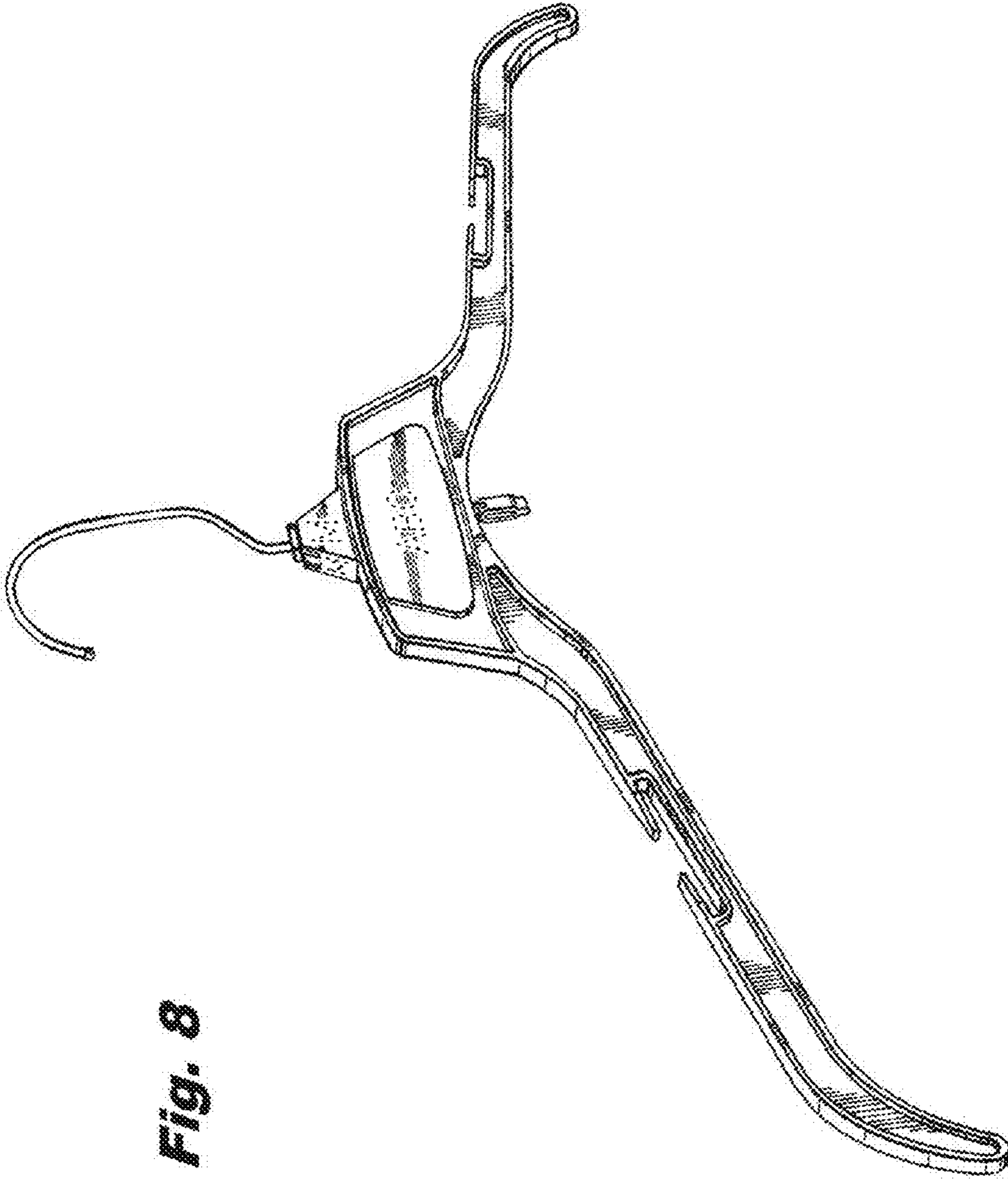

Fig. 8

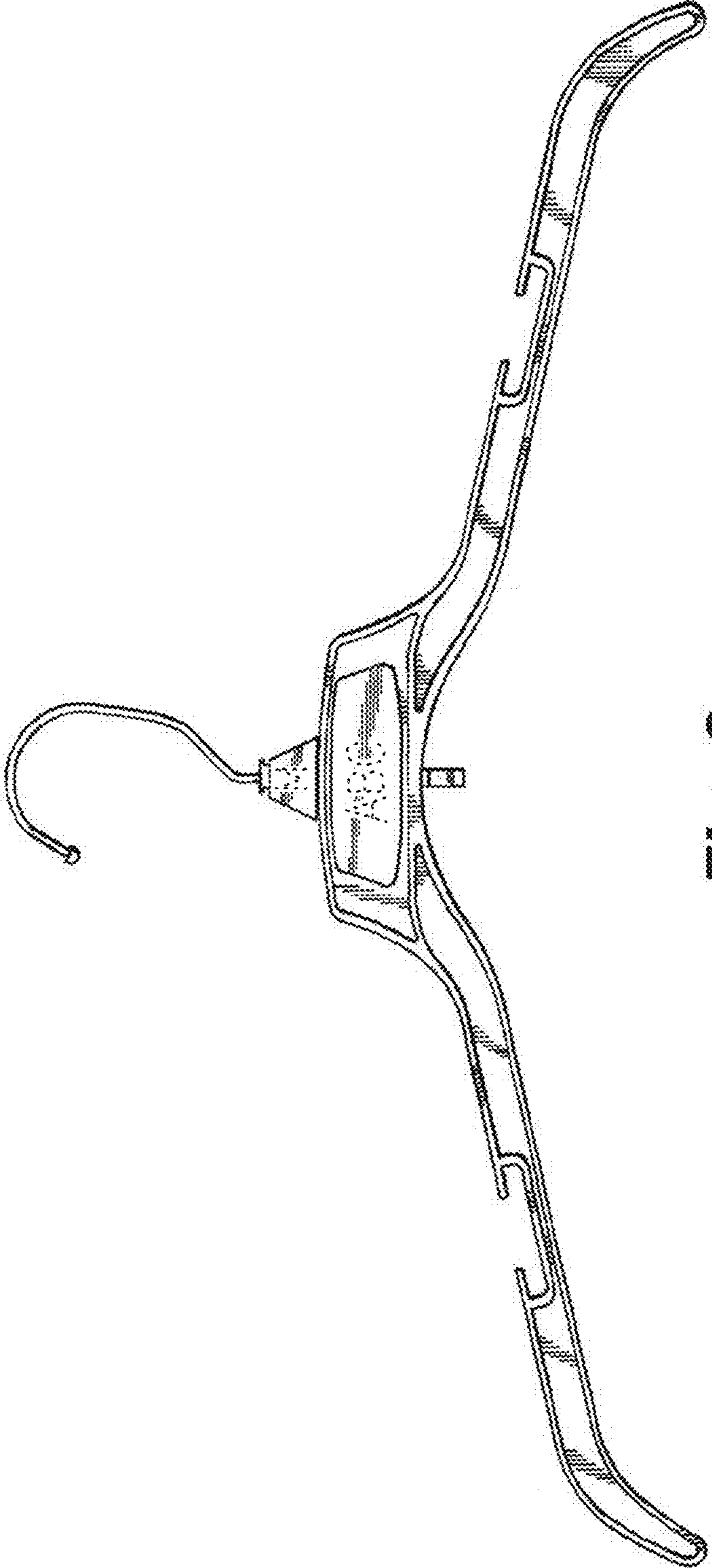

Fig. 9

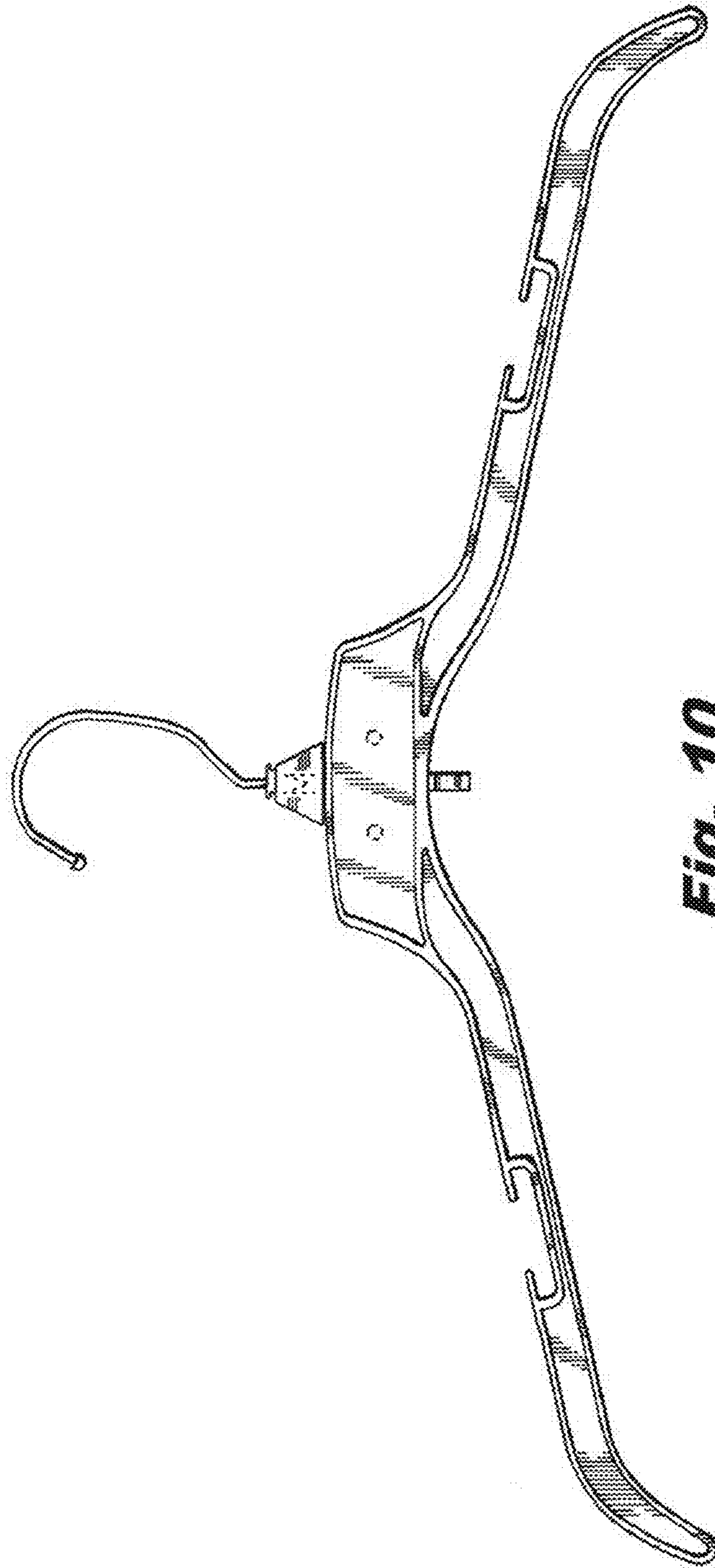

Fig. 10



Fig. 11



Fig. 12



Fig. 13

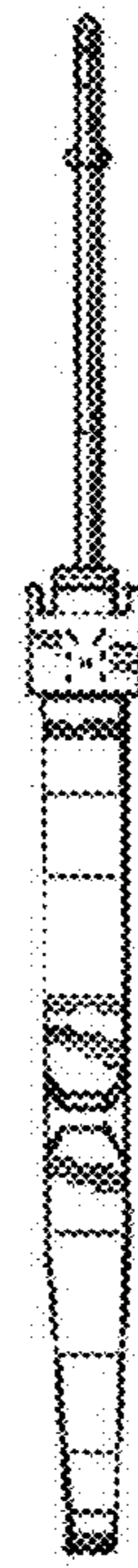

Fig. 14