



US00D654627S

(12) **United States Design Patent**  
**Anderson**

(10) **Patent No.:** **US D654,627 S**

(45) **Date of Patent:** **\*\* Feb. 21, 2012**

(54) **BACK SCRATCHER**

(76) Inventor: **Patrick T. Anderson**, Grass Valley, CA  
(US)

(\*\*) Term: **14 Years**

(21) Appl. No.: **29/370,677**

(22) Filed: **Aug. 23, 2010**

(51) **LOC (9) Cl.** ..... **28-99**

(52) **U.S. Cl.** ..... **D28/91.2; D4/130**

(58) **Field of Classification Search** ..... D28/91.2;  
15/222, 160; D24/200, 211, 214; 601/143,  
601/136-138; D4/136, 130

See application file for complete search history.

(56) **References Cited**

**U.S. PATENT DOCUMENTS**

3,478,369	A *	11/1969	Ensley	.....	601/136
3,802,421	A	4/1974	Williams		
4,071,021	A	1/1978	Gallacci		
D282,689	S *	2/1986	McCormick	.....	D28/91.2
6,026,531	A *	2/2000	Pruitt	.....	15/160
D428,996	S *	8/2000	Gonzales	.....	D24/211
6,110,132	A	8/2000	Karpieski		
2009/0088672	A1 *	4/2009	Vaughan et al.	.....	601/136
2011/0166481	A1 *	7/2011	Rhoad et al.	.....	601/1

\* cited by examiner

*Primary Examiner* — Jennifer Rivard

(74) *Attorney, Agent, or Firm* — Paul R. Martin

(57) **CLAIM**

The ornamental design for a back scratcher, as shown and described.

**DESCRIPTION**

FIG. 1 is a perspective view of my new design for a back scratcher.

FIG. 2 is another perspective view of my new design for a back scratcher showing it mounted to a vertical post.

FIG. 3 is an elevational view of the front of my new design for a back scratcher.

FIG. 4 is a elevational view of the rear of my new design for a back scratcher.

FIG. 5 is a plan view from the top of my new design for a back scratcher. A plan view from the bottom would be a mirror image thereof; and,

FIG. 6 is an elevational view of one side of my new design for a back scratcher.

An elevational view from the opposite side would be a mirror image thereof.

The broken line outline of the post shown in FIG. 2 is an environmental element and forms no part of the invention.

**1 Claim, 3 Drawing Sheets**

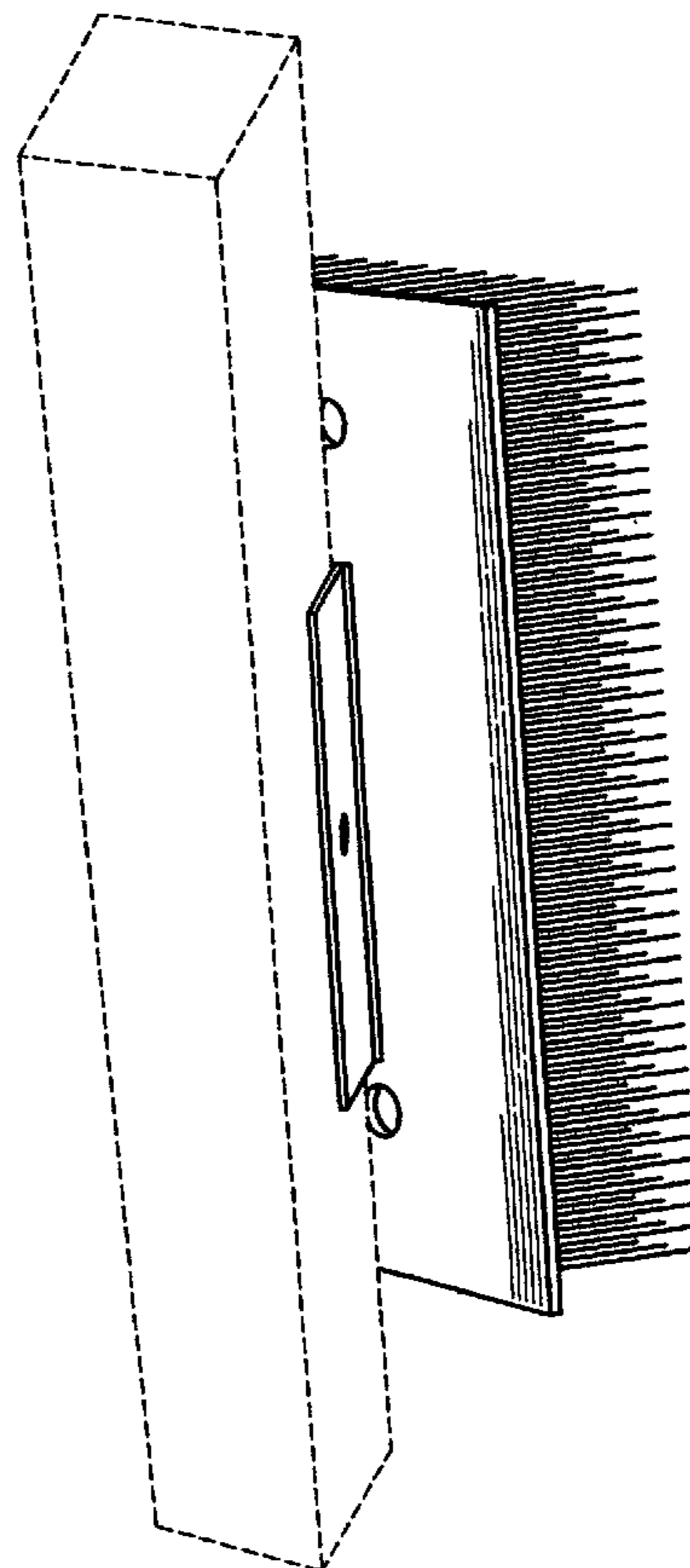
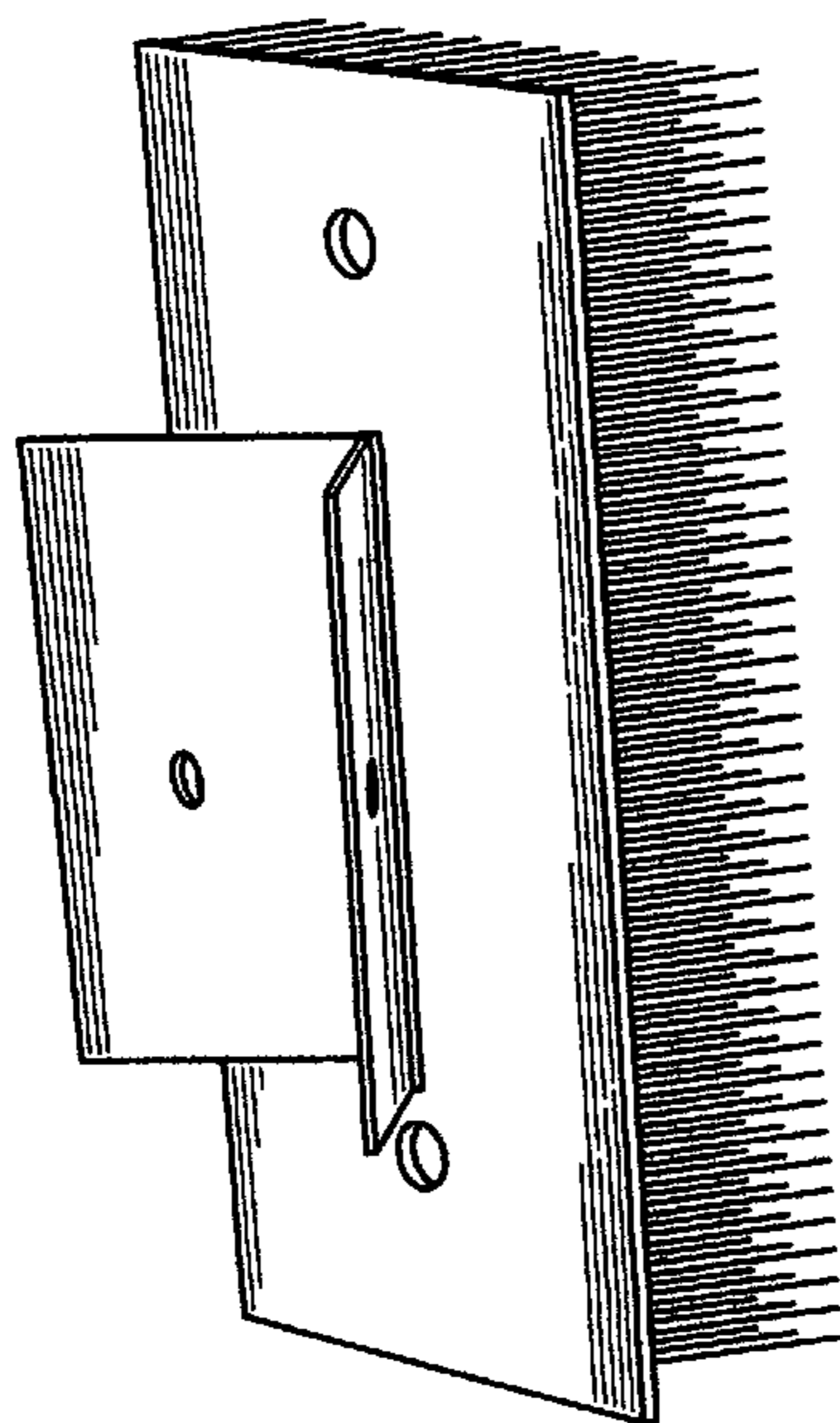

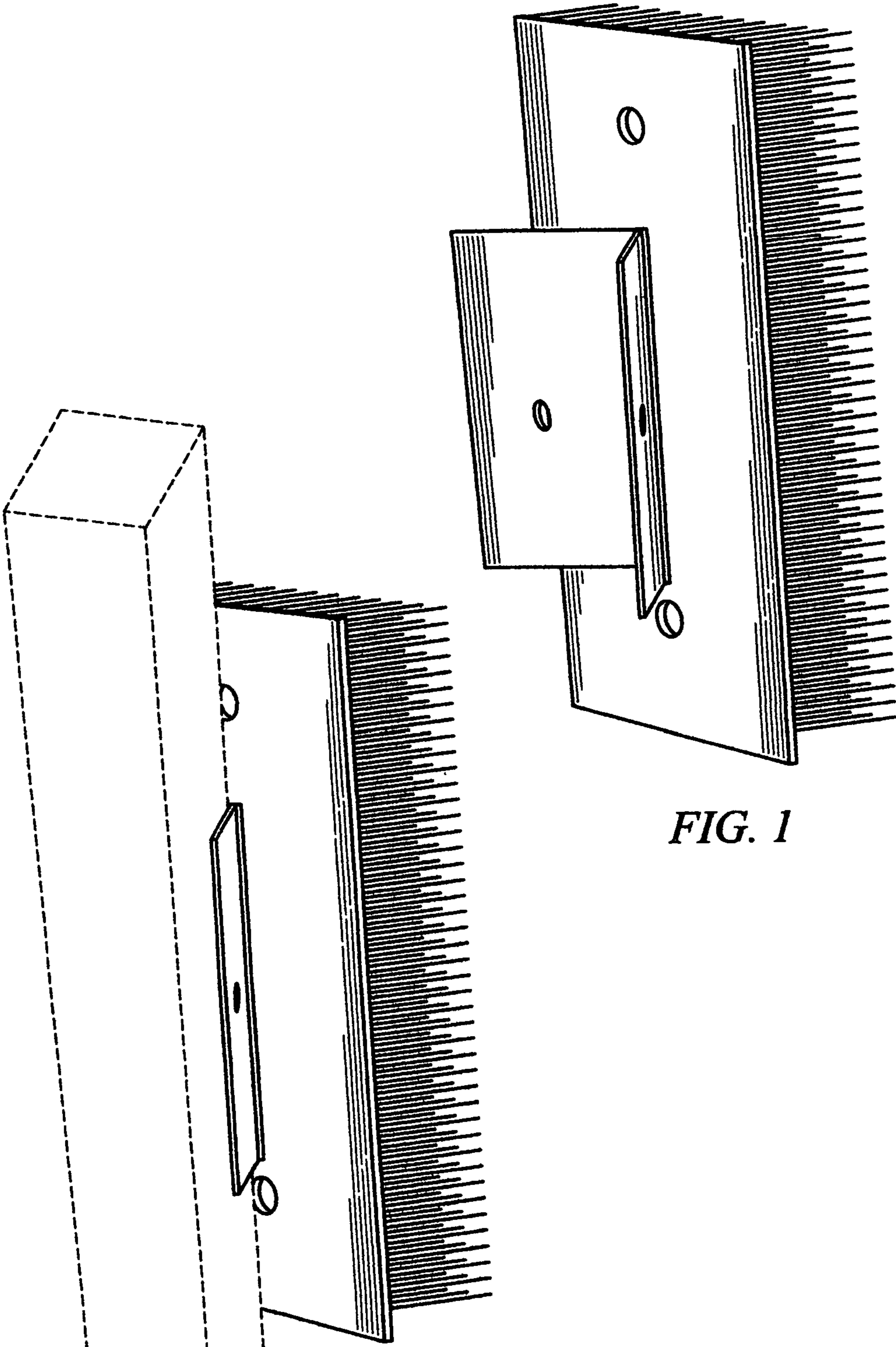
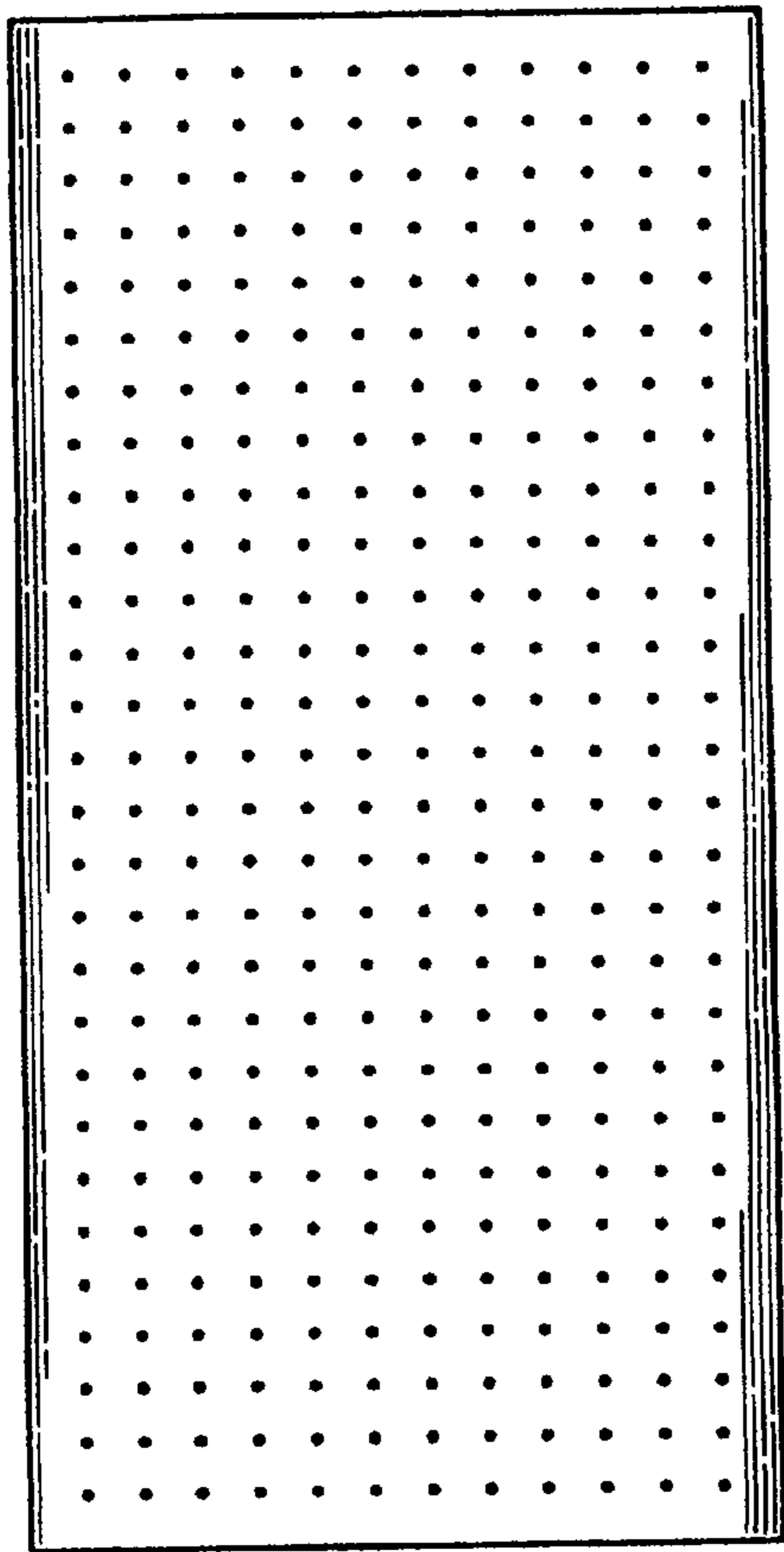
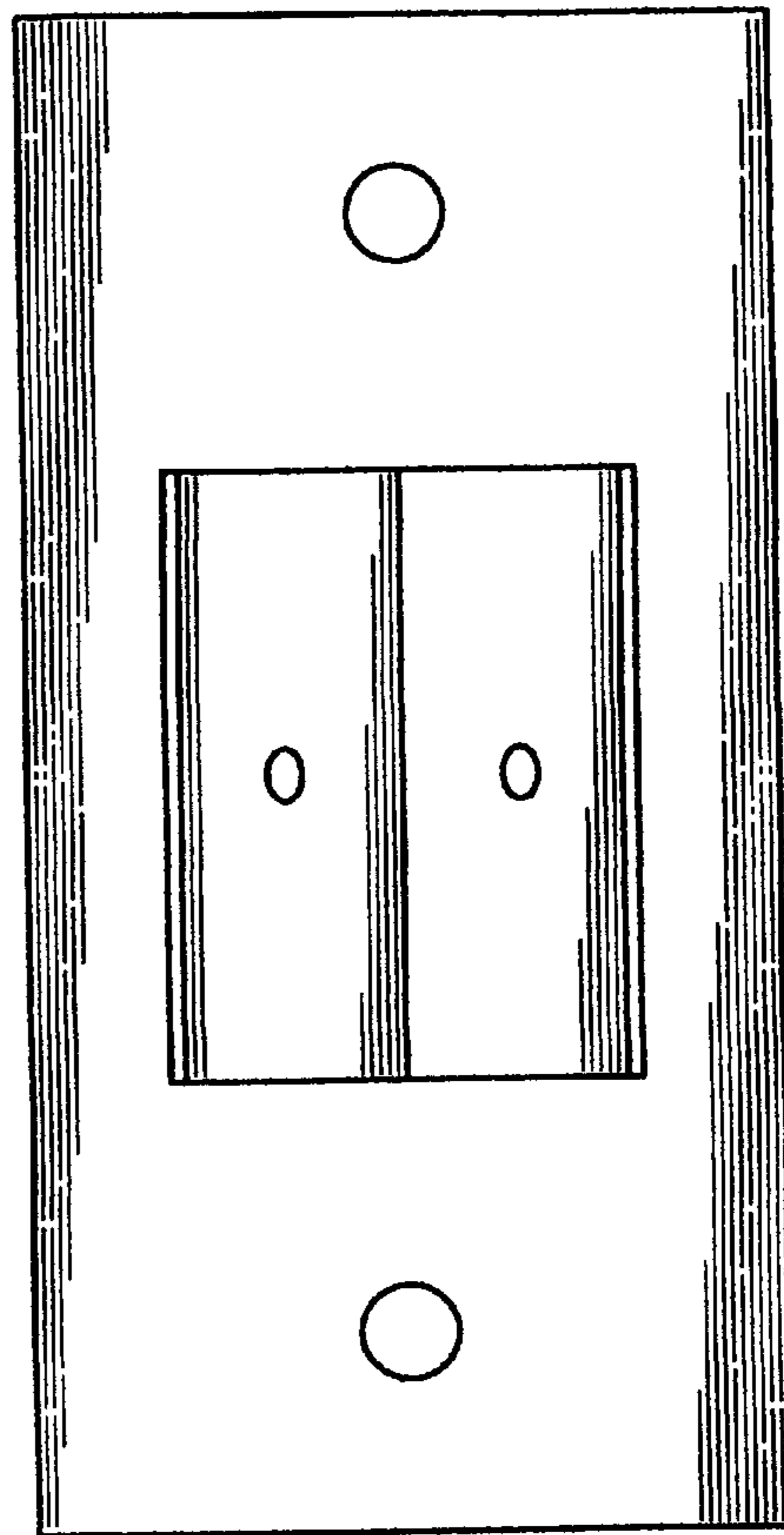

FIG. 1

FIG. 2



*FIG. 3*



*FIG. 4*

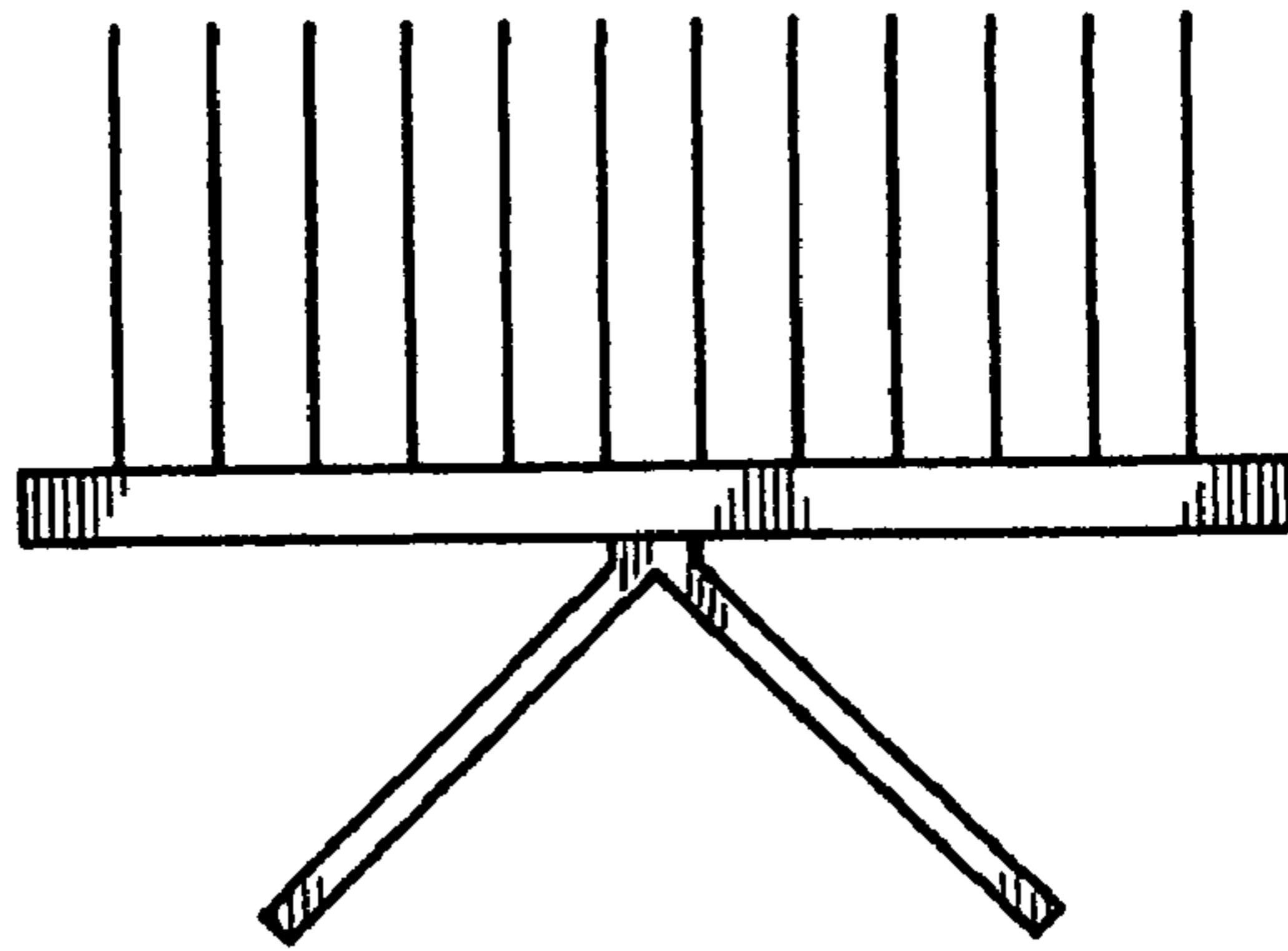

*FIG. 5*

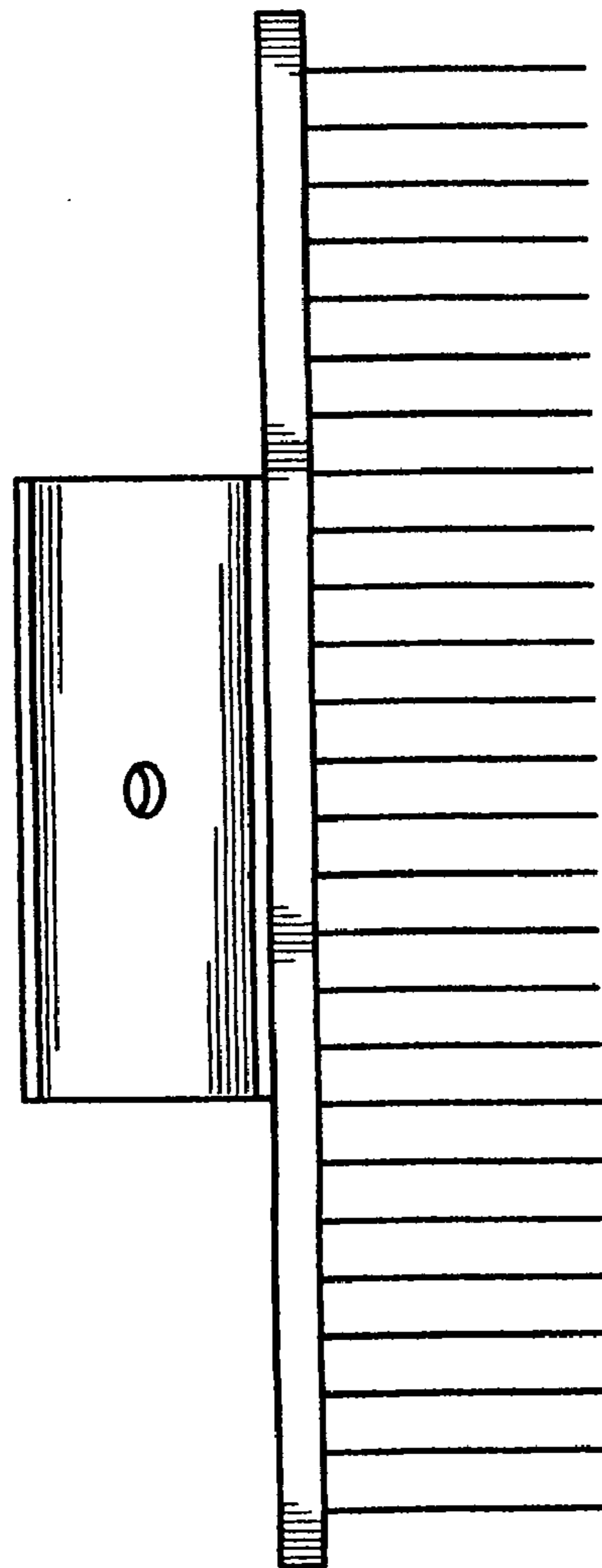

*FIG. 6*