



US00D654536S

(12) **United States Design Patent**
Metti et al.

(10) **Patent No.:** **US D654,536 S**

(45) **Date of Patent:** **** Feb. 21, 2012**

(54) **INK KIT**

(75) Inventors: **Peter A. Metti**, New York City, NY (US); **Alan Schissel**, New York, NY (US)

(73) Assignee: **Cik Partners, LLC**, New York, NY (US)

(**) Term: **14 Years**

(21) Appl. No.: **29/374,659**

(22) Filed: **Sep. 15, 2011**

(51) **LOC (9) Cl.** **19-08**

(52) **U.S. Cl.** **D19/10**

(58) **Field of Classification Search** D19/1-10;
D20/22, 27; 40/124.01-124.18, 1.5, 360;
281/2, 5, 38, 541; 235/487; 283/58, 72,
283/61-62, 74-75, 77-78, 80-89, 90-109,
283/900, 904; 428/343, 351-352

See application file for complete search history.

(56) **References Cited**

U.S. PATENT DOCUMENTS

2,666,655	A *	1/1954	Wolowitz	462/64
4,229,023	A *	10/1980	Luz	283/77
4,410,576	A *	10/1983	Publicover	428/79
D284,581	S *	7/1986	Peterson	D19/10
4,681,348	A *	7/1987	Mowry, Jr.	283/58
D415,194	S *	10/1999	Thompson	D19/1
D456,840	S *	5/2002	Vachon	D19/10
D533,219	S *	12/2006	Hodsdon	D19/2

* cited by examiner

Primary Examiner — Caron D Veynar

Assistant Examiner — Abraham Bahta

(74) *Attorney, Agent, or Firm* — Law Offices of Alozie N. Etufugh, PLLC

(57) **CLAIM**

The ornamental design for an ink kit, as shown and described.

DESCRIPTION

FIG. 1 is a front view of the present invention thereof;
 FIG. 2 is a rear view of the present invention thereof;
 FIG. 3 is a top view of the present invention, which is a mirror image of the bottom view thereof;
 FIG. 4 is a right side elevational view of the present invention, which is a mirror image of the left side elevational view, thereof;
 FIG. 5 is a front perspective view of the present invention thereof showing removal of adhesive film from the front panel of the present invention;
 FIG. 6 is a front perspective view of the present invention thereof showing the separation of the two components of the present invention;
 FIG. 7 is a rear perspective view of the present invention thereof showing removal of adhesive film from the rear panel of the present invention;
 FIG. 8 is a rear perspective view of the present invention thereof showing the separation of the two components of the present invention;
 FIG. 9 is a plan view of the interior of the two components of the present invention thereof; and,
 FIG. 10 is an environmental perspective view of the present invention thereof; the surrounding environmental structure(s) in this view are not part of the design sought to be patented; the patented subject matter in FIG. 10 is limited to the ink kit as previously described in FIGS. 1-9.

1 Claim, 5 Drawing Sheets

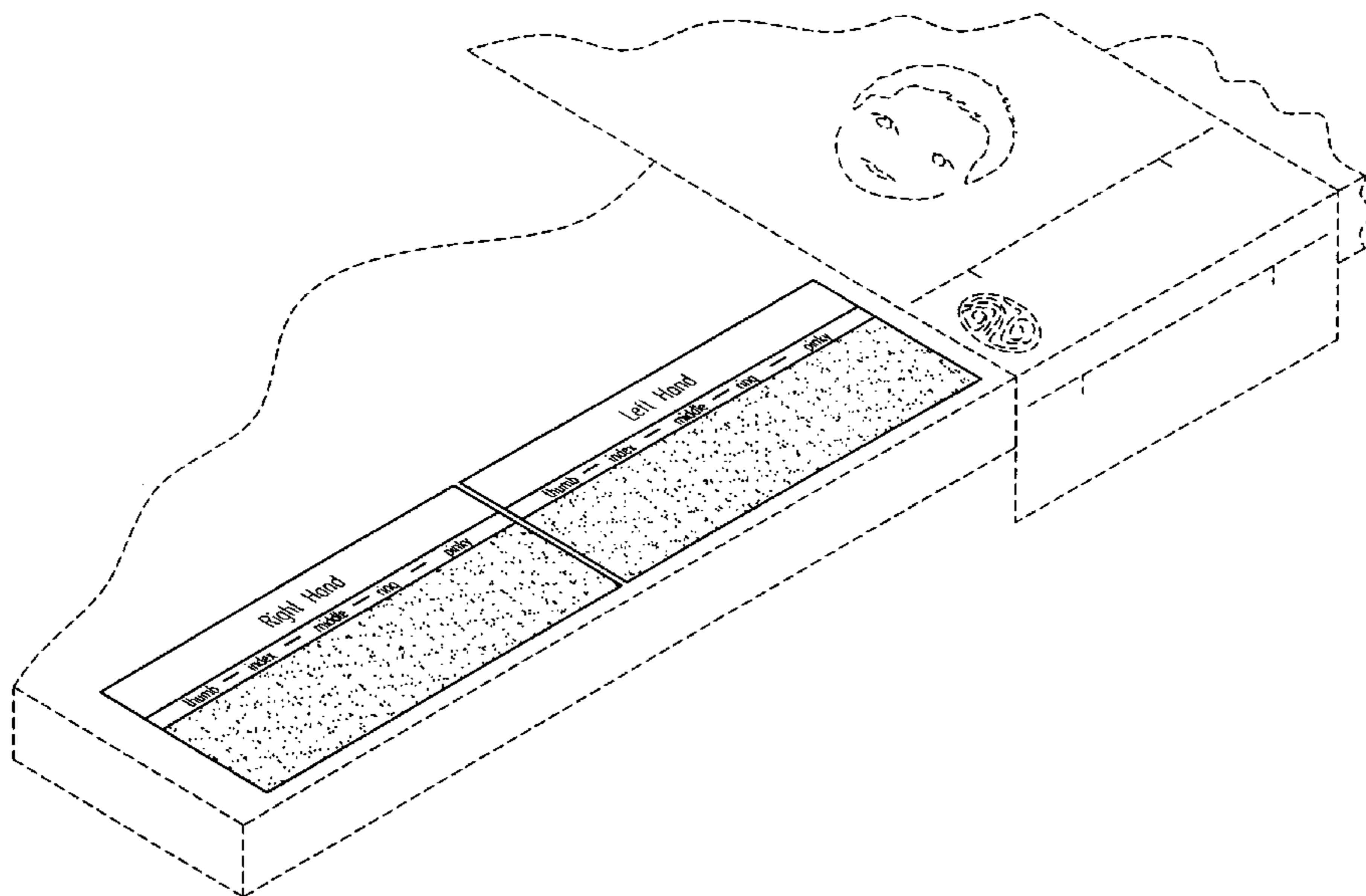

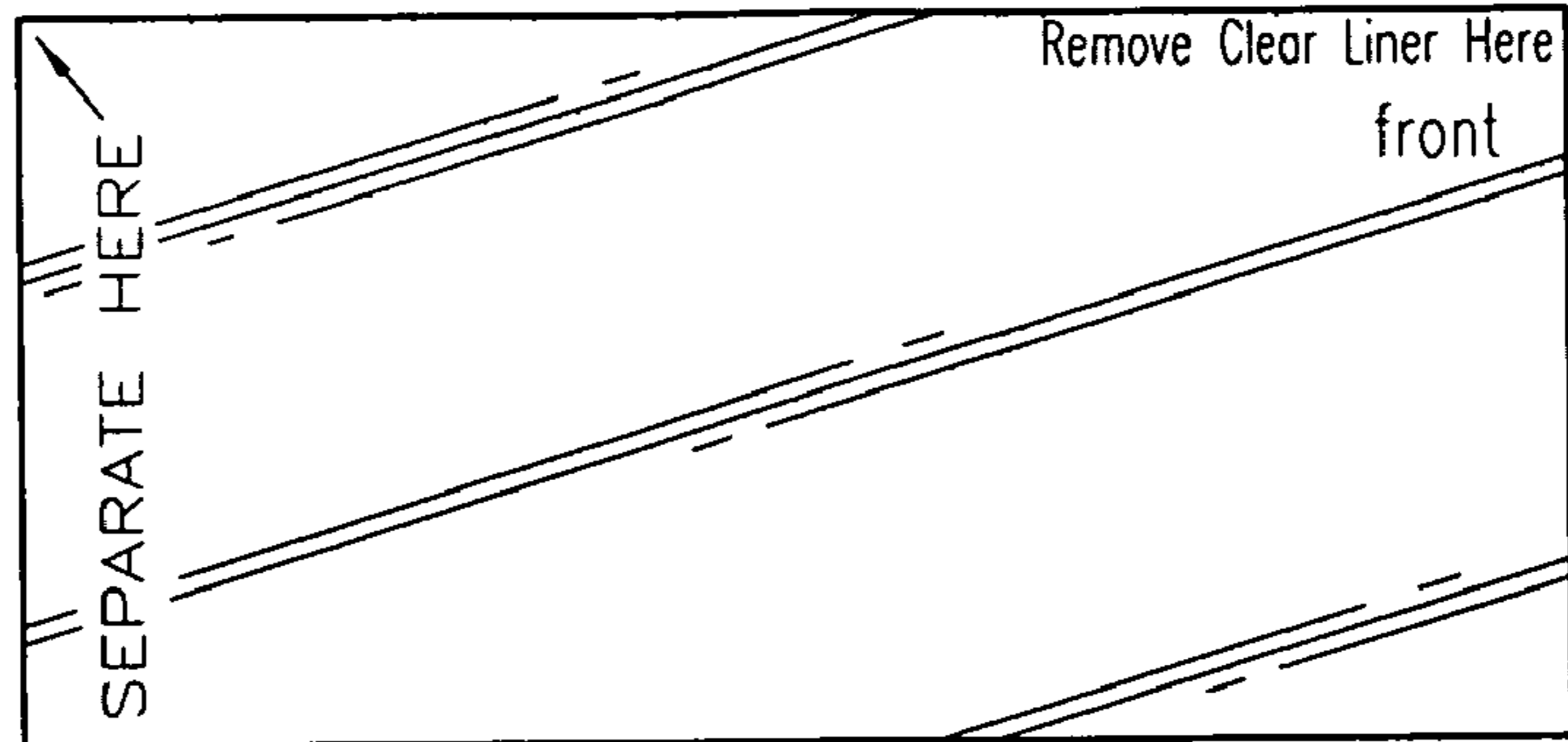

FIG. 1

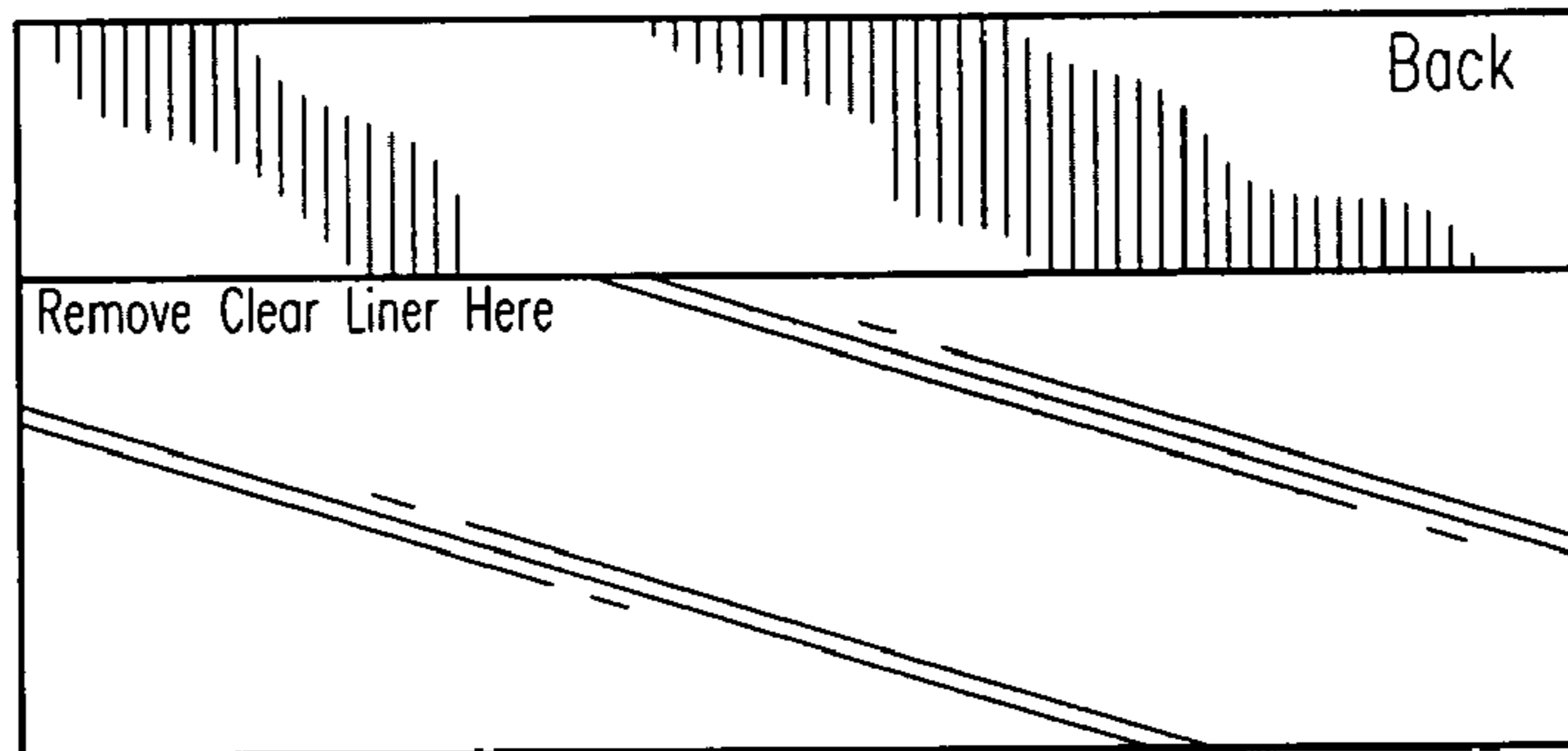

FIG. 2

FIG. 4



FIG. 3

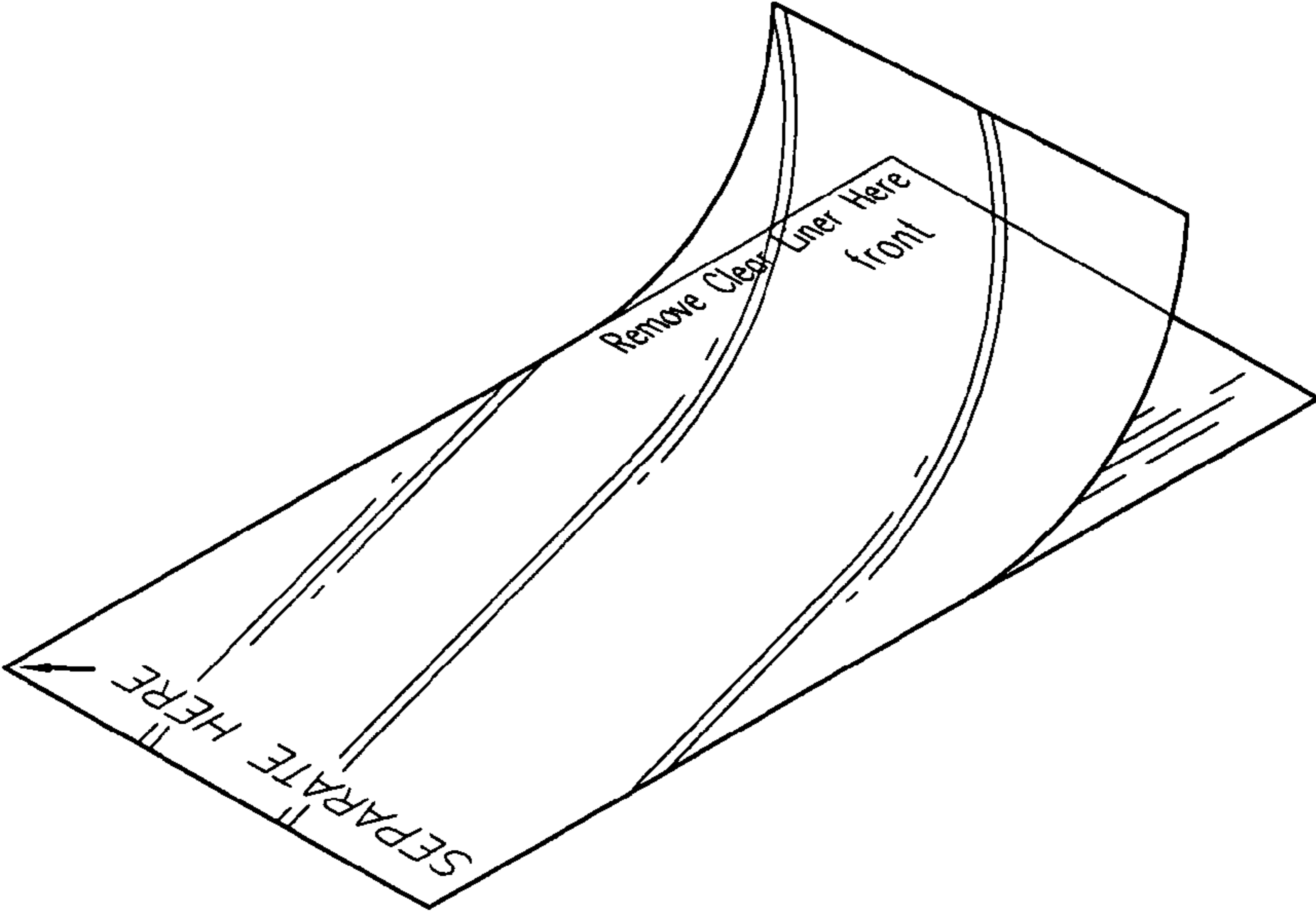

FIG. 5

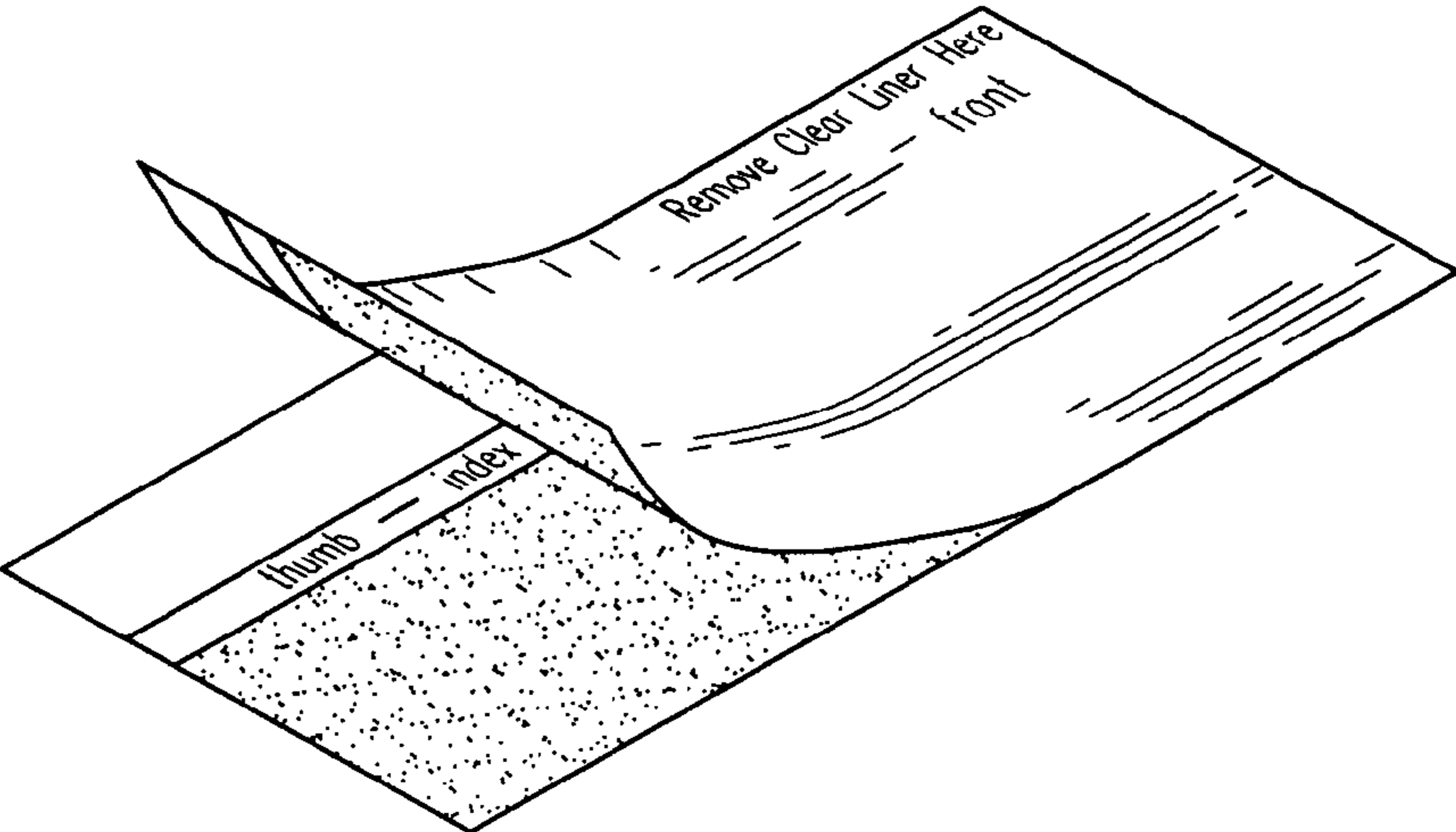

FIG. 6

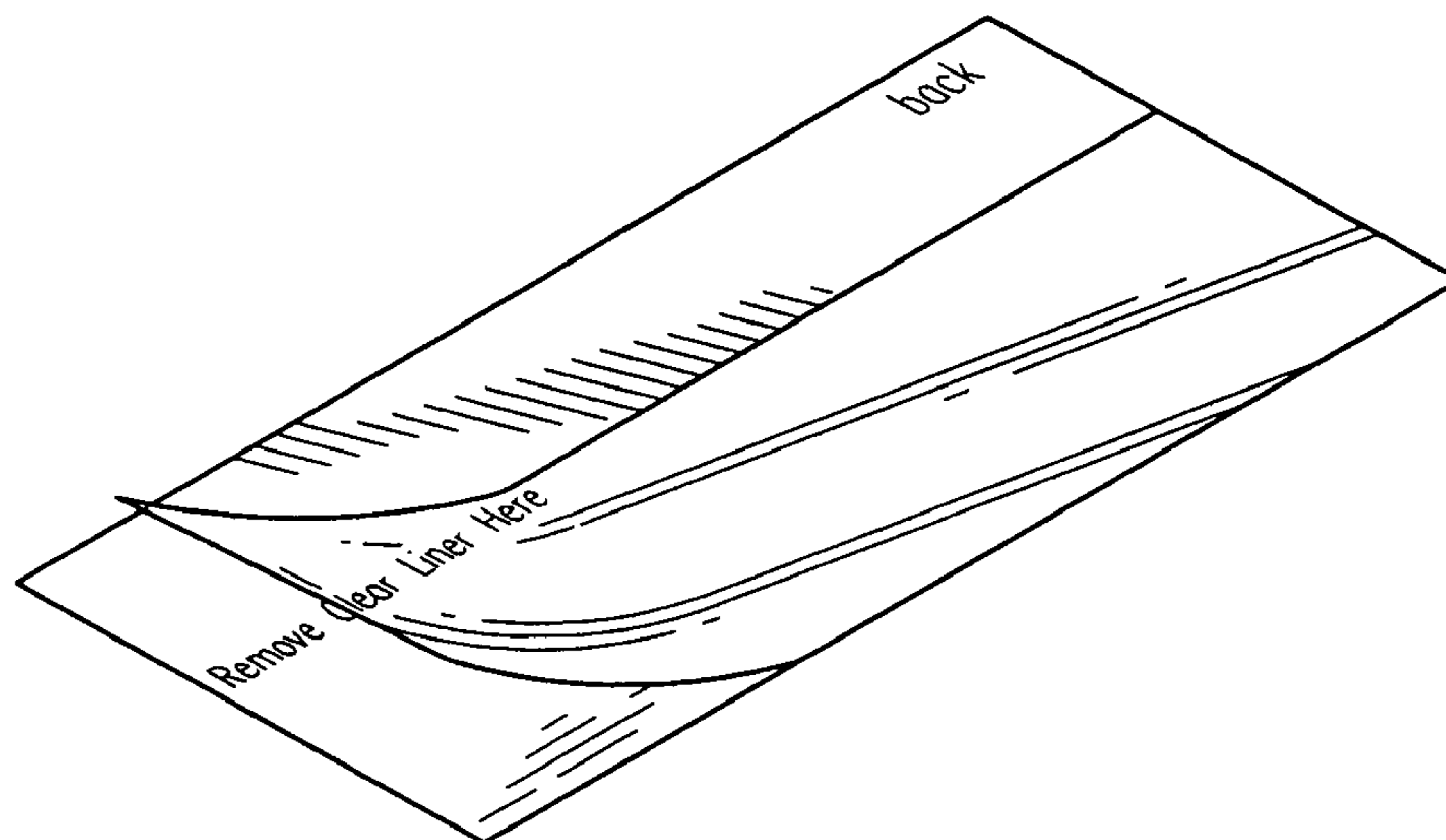

FIG. 7

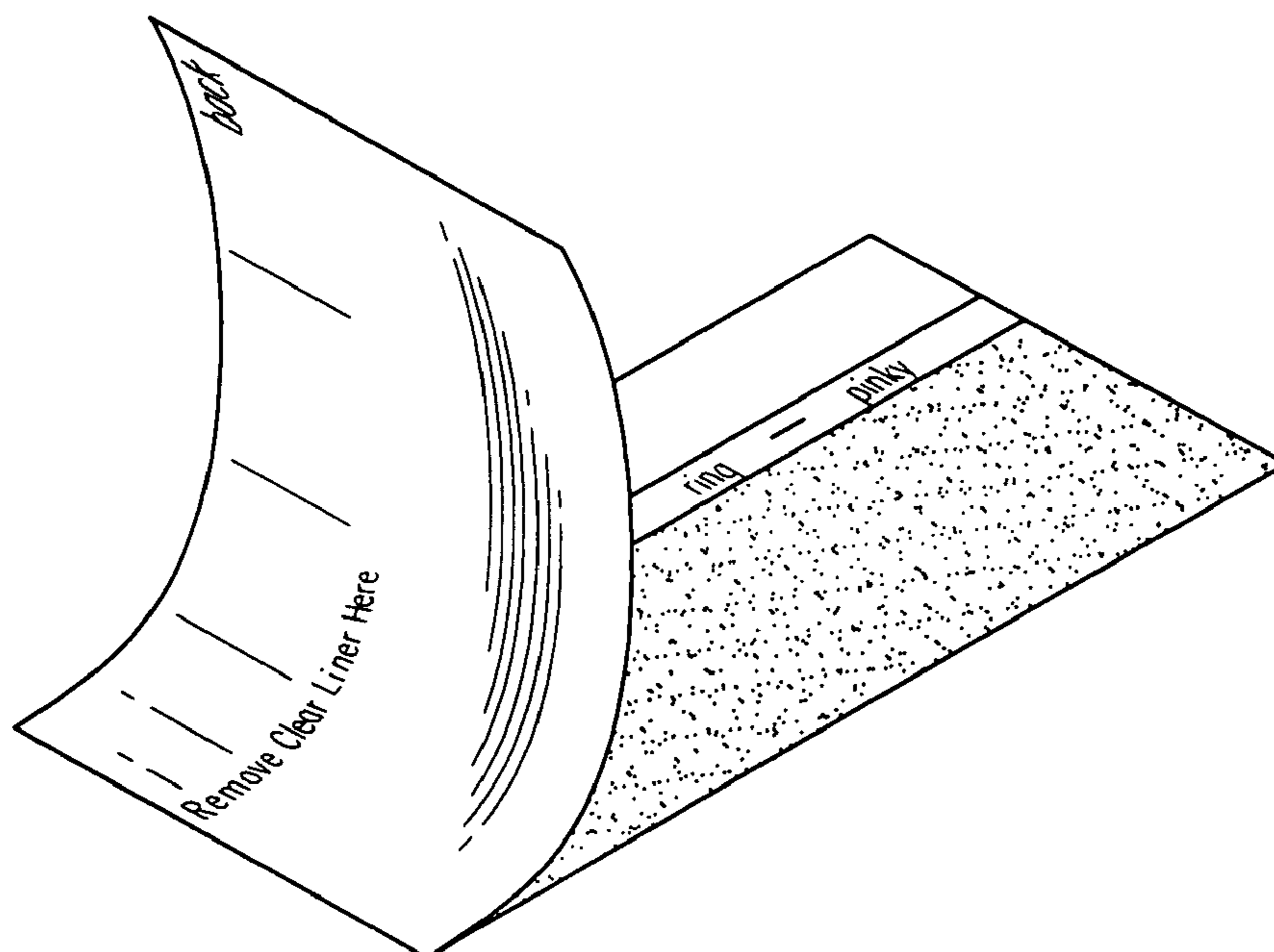

FIG. 8

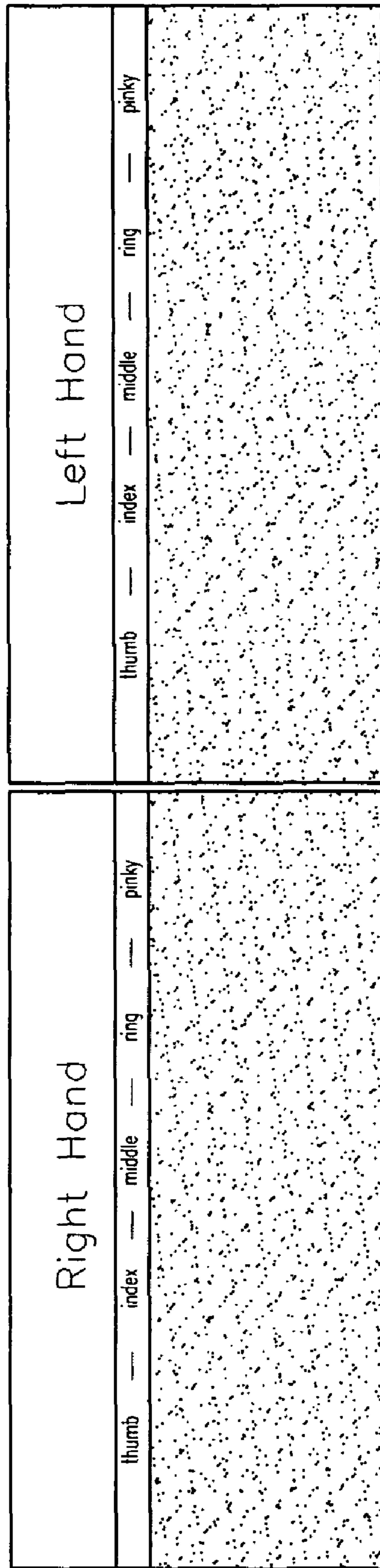

FIG. 9

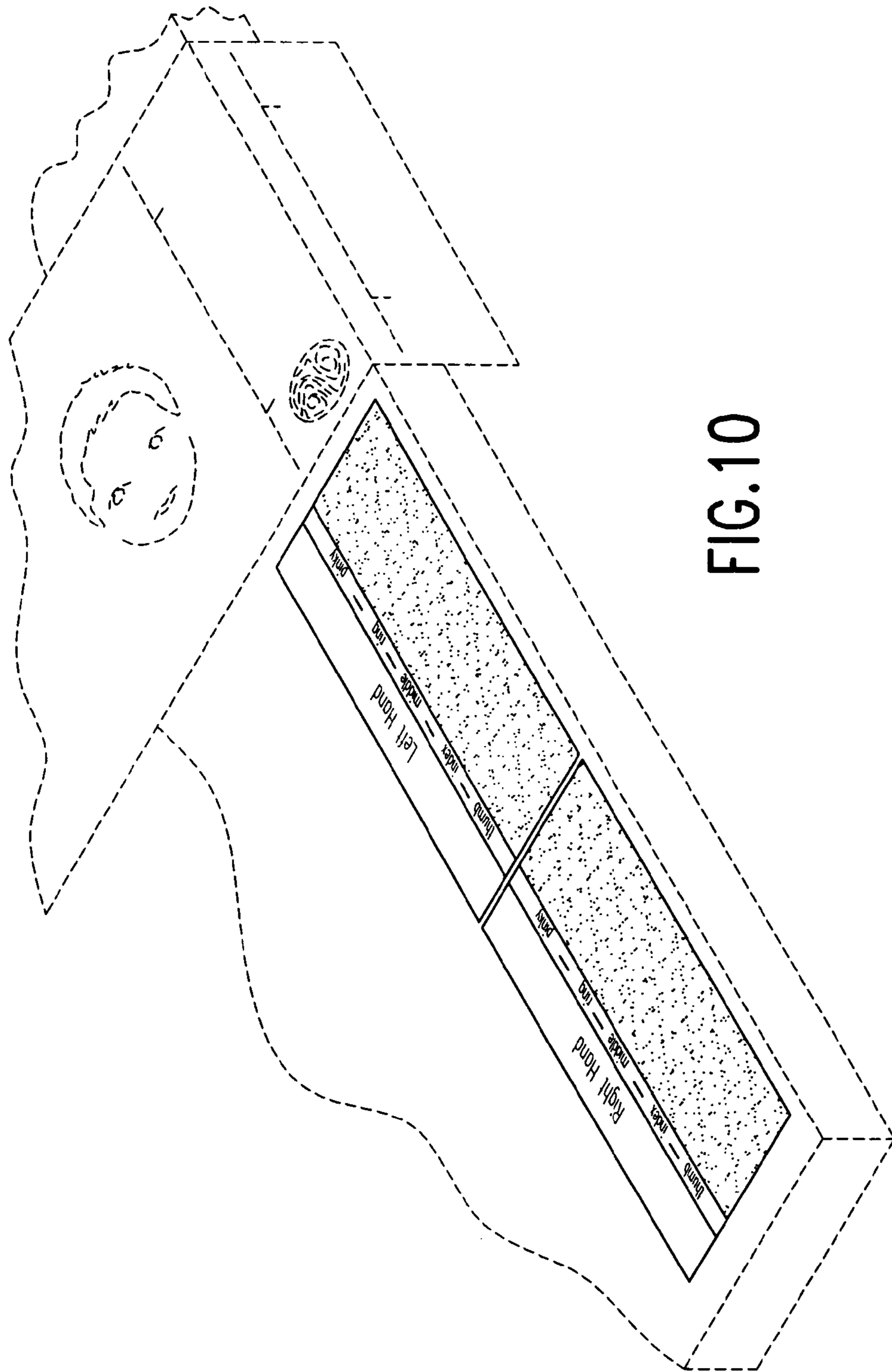

FIG.10