



US00D654437S

(12) **United States Design Patent**
Fitch

(10) **Patent No.:** **US D654,437 S**

(45) **Date of Patent:** **** Feb. 21, 2012**

(54) **CHARGER**

(75) Inventor: **Jonathan A. Fitch**, Syracuse, NY (US)

(73) Assignee: **Eveready Battery Company, Inc.**, St. Louis, MO (US)

(**) Term: **14 Years**

(21) Appl. No.: **29/404,222**

(22) Filed: **Oct. 18, 2011**

(51) **LOC (9) Cl.** **13-03**

(52) **U.S. Cl.** **D13/144**

(58) **Field of Classification Search** D13/107,
D13/108, 110, 118, 119, 120, 133, 144, 154,
D13/184, 199; 320/107-109; 363/13, 146;
439/300, 620.01, 638, 668-670, 675, 825
See application file for complete search history.

(56) **References Cited**

U.S. PATENT DOCUMENTS

D492,249 S * 6/2004 Suomalainen et al. D13/108
7,679,322 B1 * 3/2010 Griffin 320/114

D613,692 S * 4/2010 Son et al. D13/144
D614,136 S * 4/2010 Chyan et al. D13/144
D619,567 S * 7/2010 Kwon et al. D14/224

* cited by examiner

Primary Examiner — Daniel Bui

(74) *Attorney, Agent, or Firm* — Michael C. Pophal

(57) **CLAIM**

The ornamental design for a charger, as shown and described.

DESCRIPTION

FIG. 1 is a front, top and left side perspective view of a charger showing my new design;

FIG. 2 is a rear, right and bottom perspective view thereof;

FIG. 3 is a right side elevation view thereof. The left side elevation view is a mirror image of the right side;

FIG. 4 is a front elevation view thereof;

FIG. 5 is a rear elevation view thereof;

FIG. 6 is a bottom plan view thereof; and,

FIG. 7 is a top plan view thereof.

The broken line shown in the drawing views is included for the purpose of illustrating environment and forms no part of the claimed design.

1 Claim, 3 Drawing Sheets

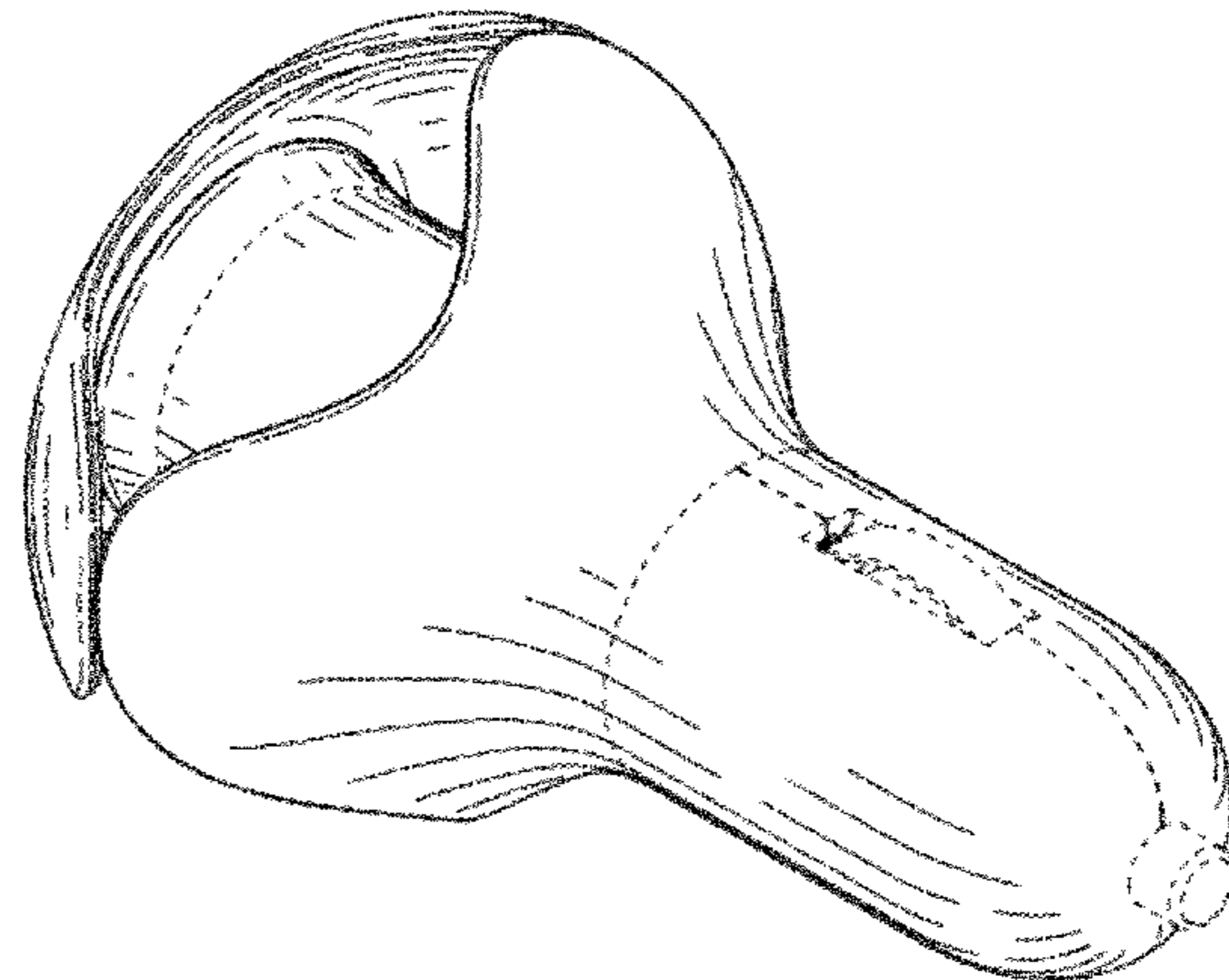
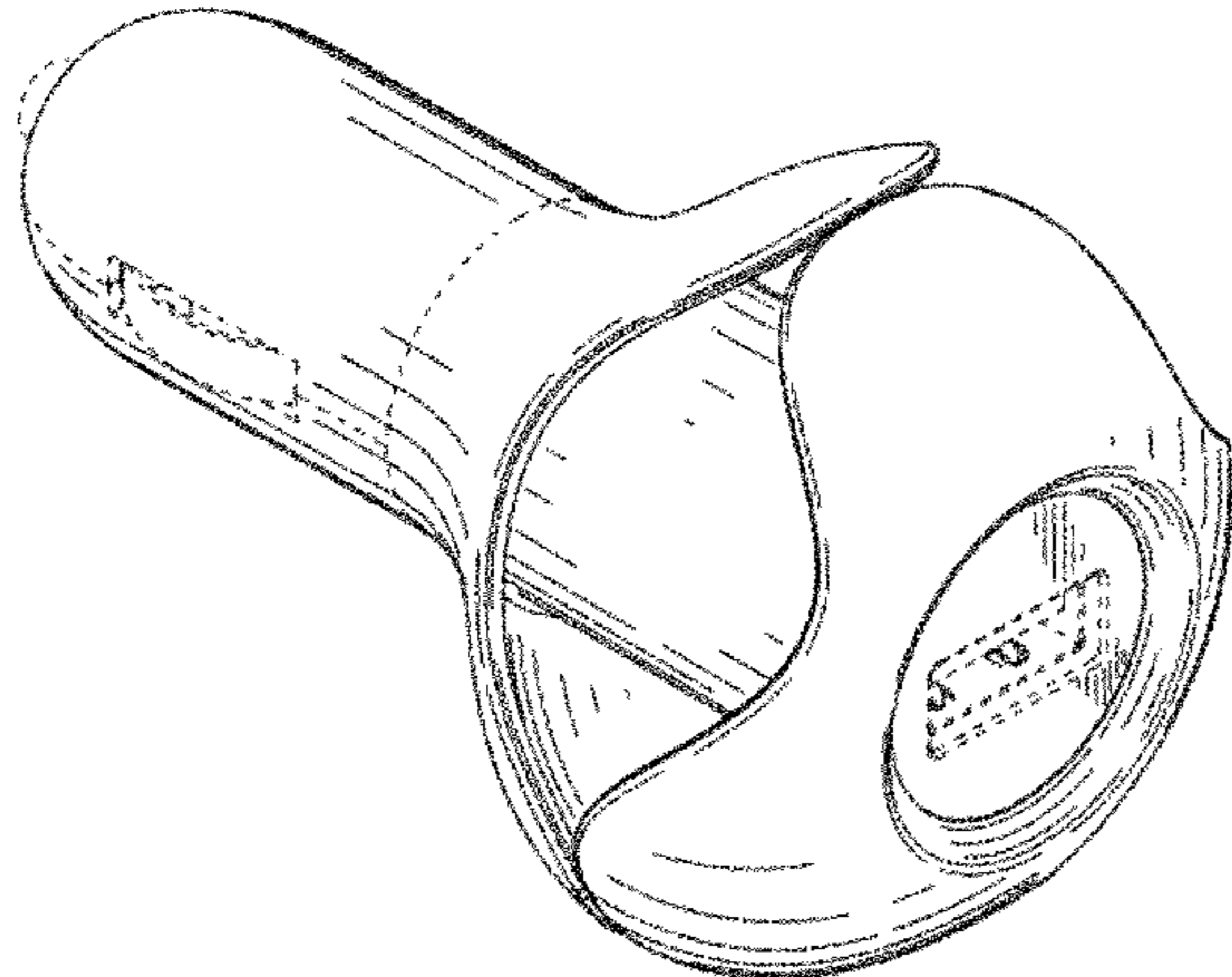

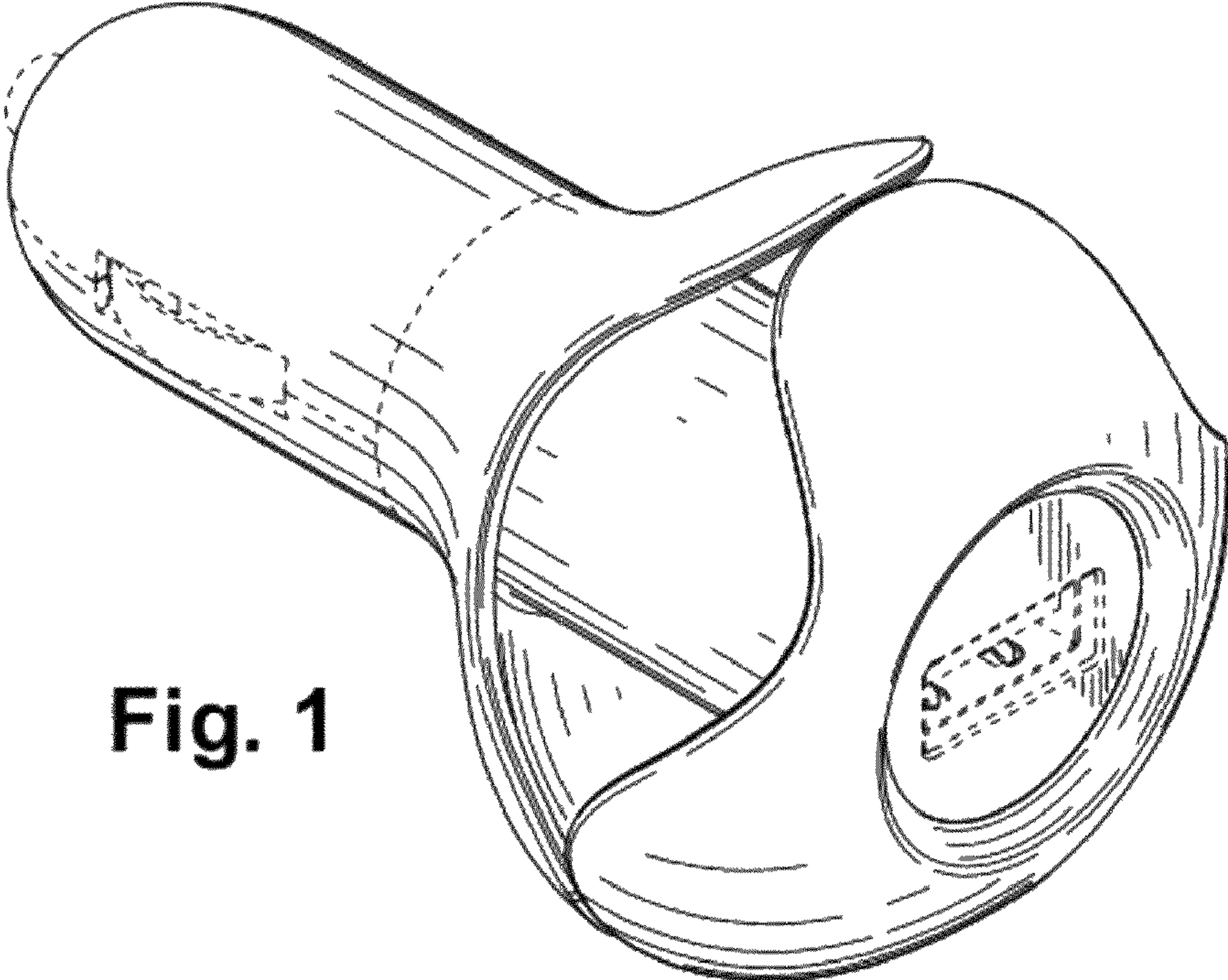

Fig. 1

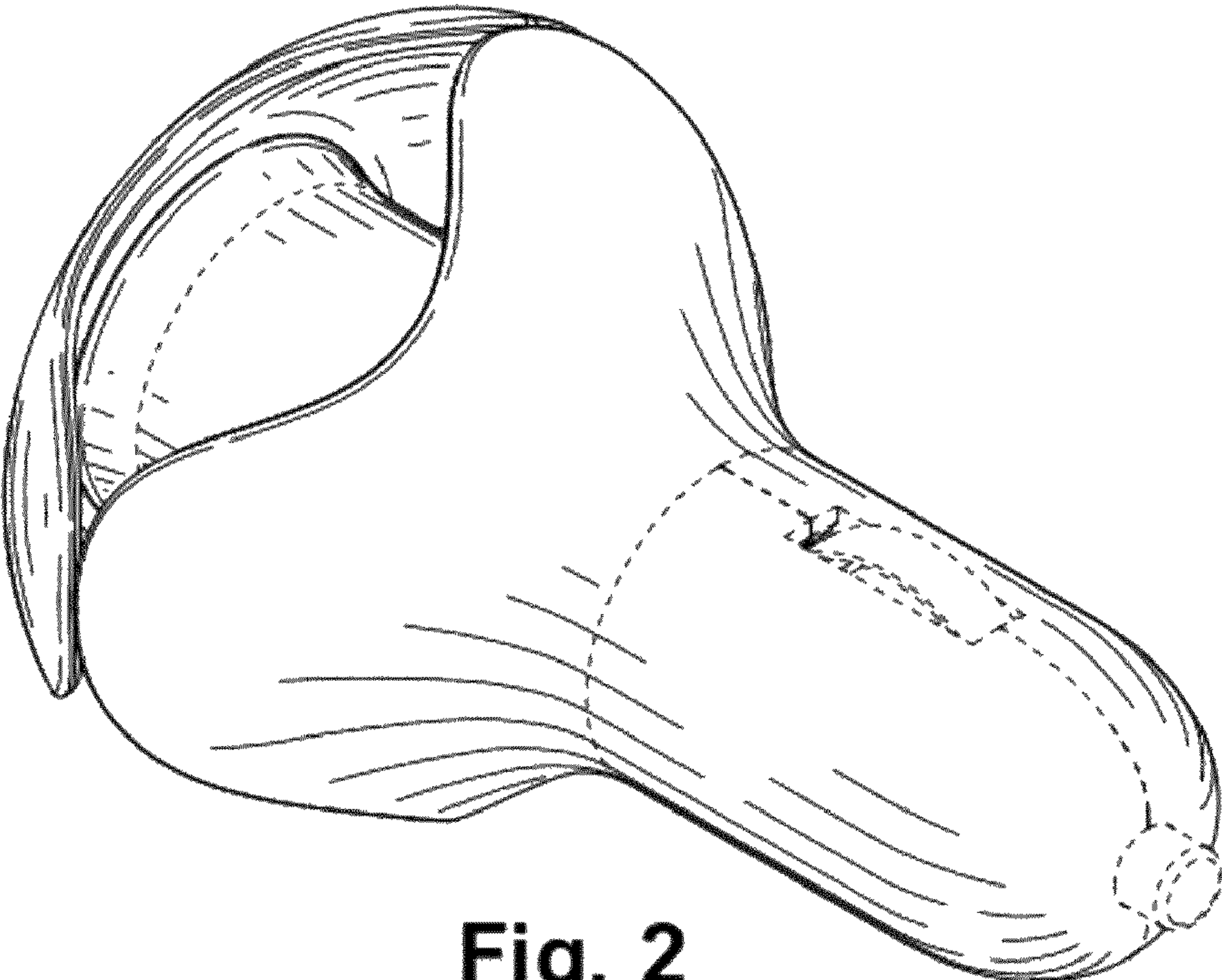

Fig. 2

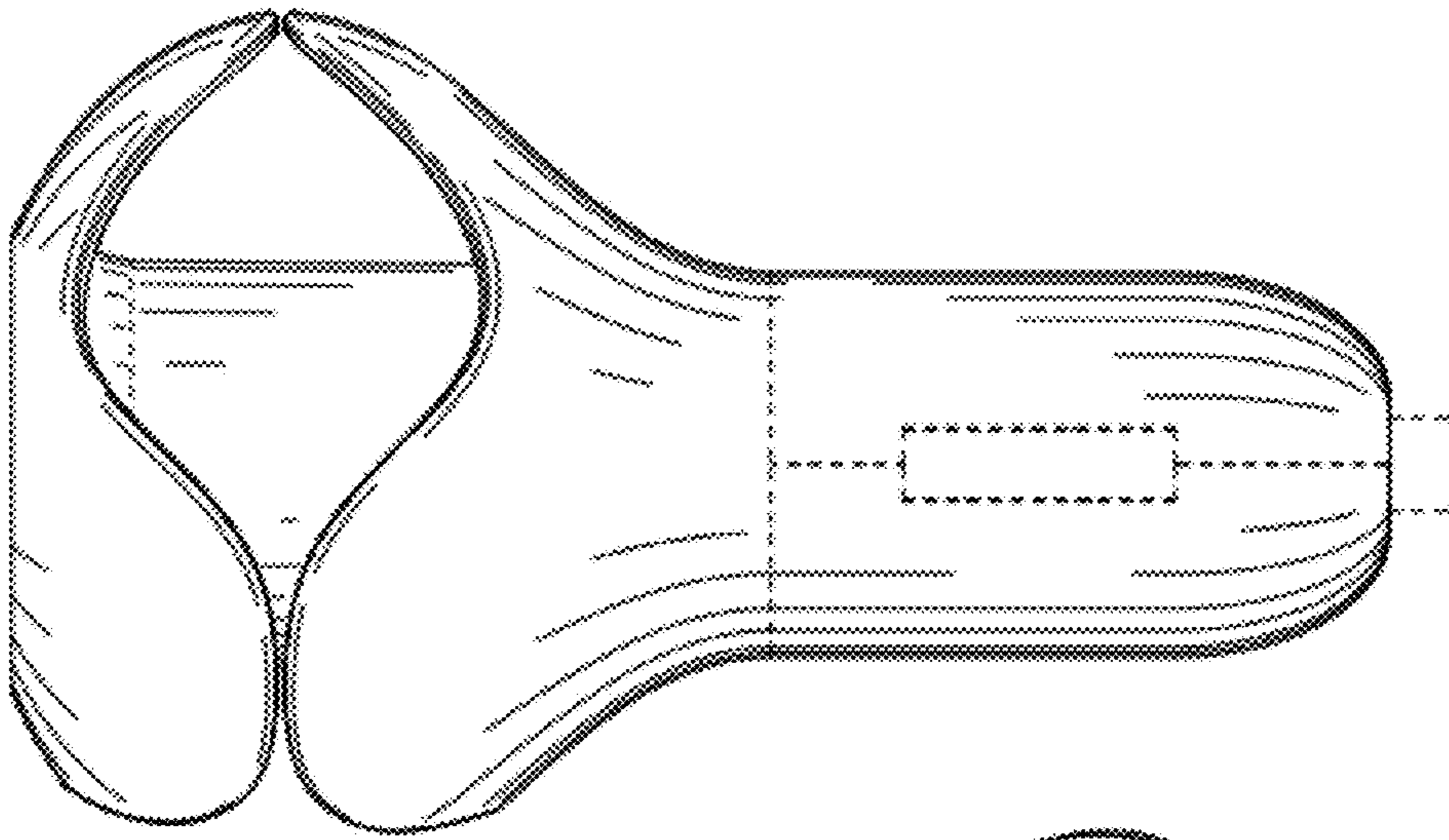

Fig. 3

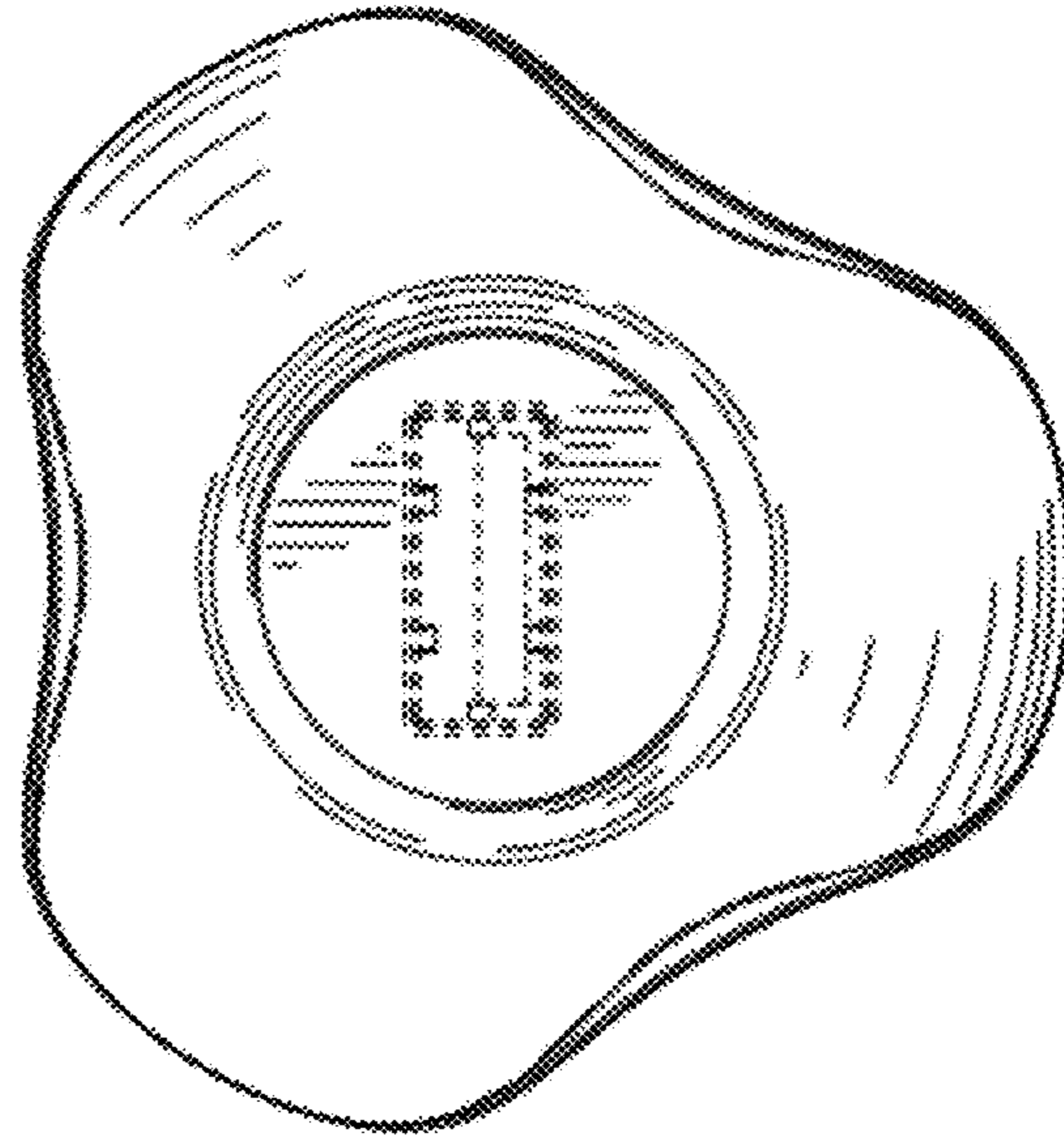

Fig. 4

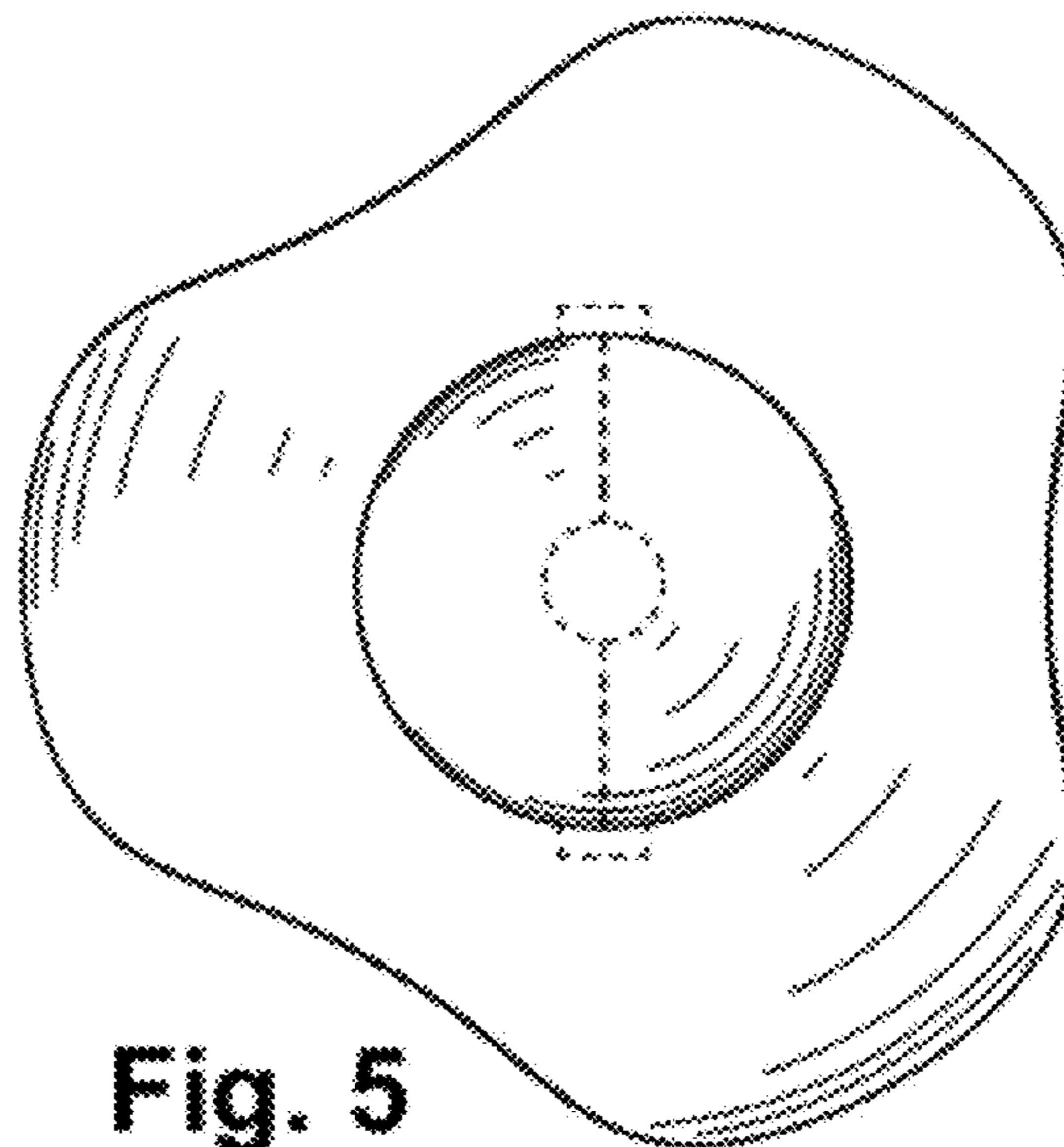

Fig. 5

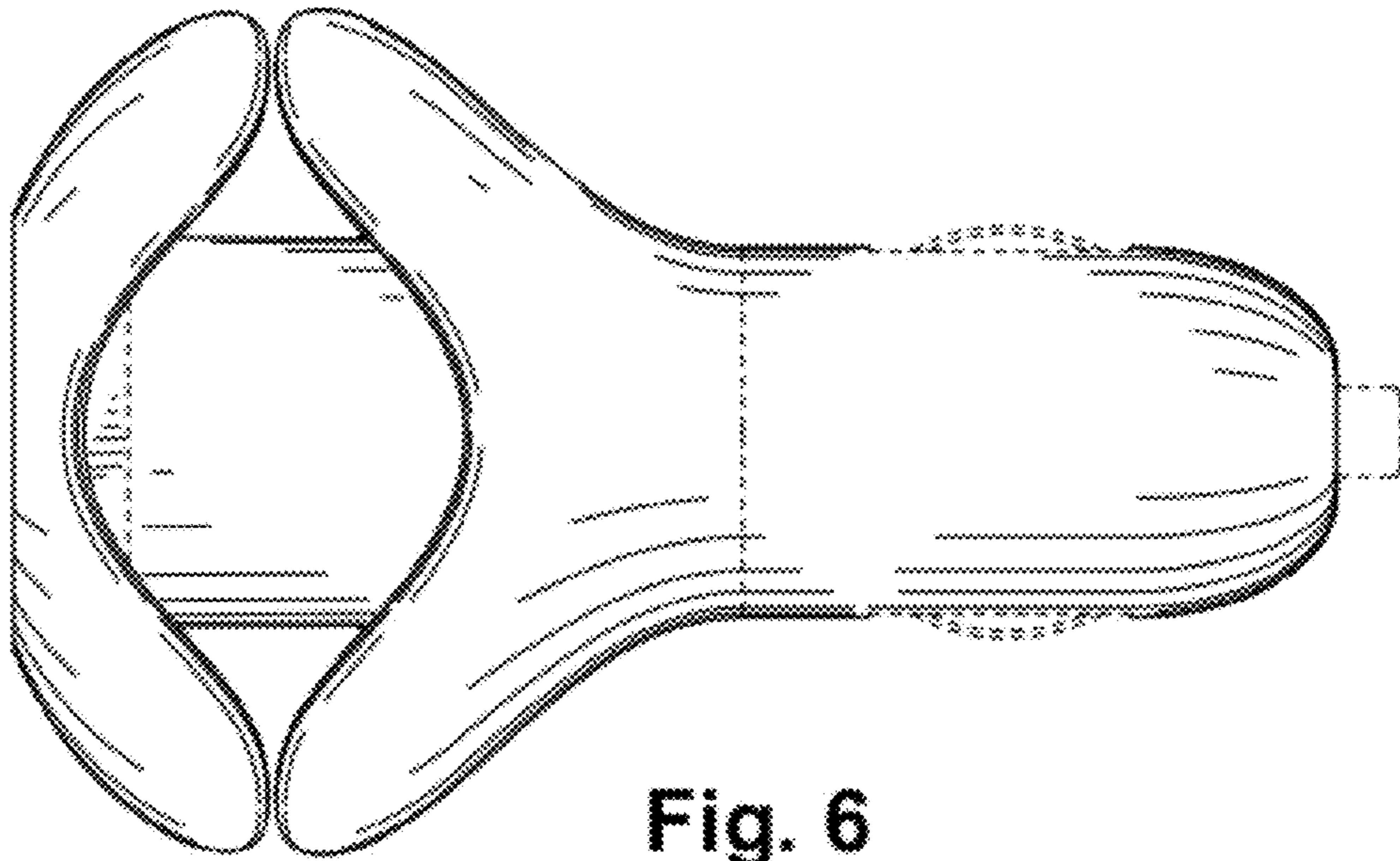

Fig. 6

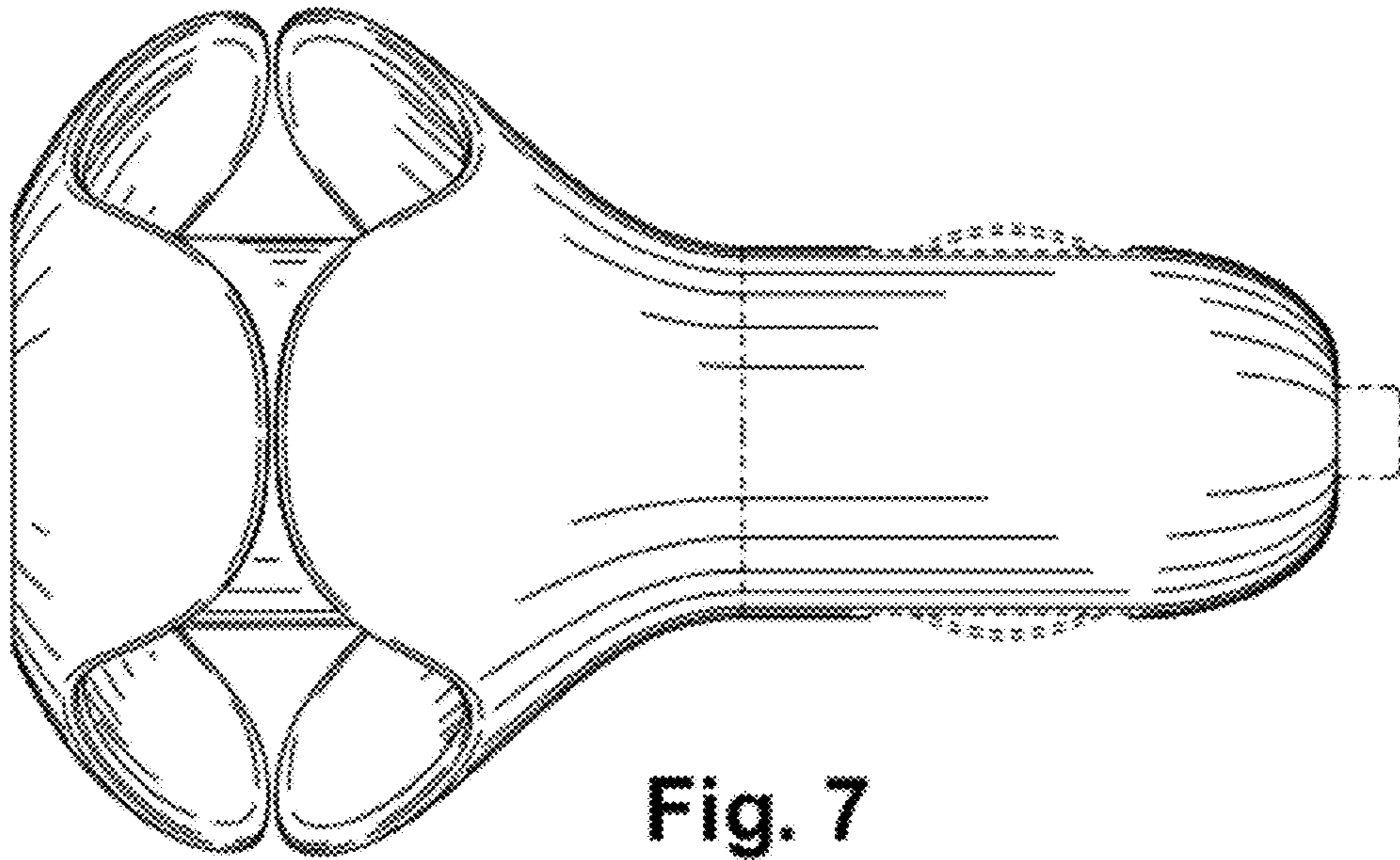

Fig. 7