



US00D654397S

(12) **United States Design Patent**
Wong

(10) **Patent No.:** **US D654,397 S**
(45) **Date of Patent:** **** Feb. 21, 2012**

(54) **BUCKLE ASSEMBLY**

(75) Inventor: **Hon Wah Wong**, Hong Kong (HK)

(73) Assignee: **Glory Metal Products Manufacturing Limited**, Hong Kong (HK)

(**) Term: **14 Years**

(21) Appl. No.: **29/384,547**

(22) Filed: **Feb. 1, 2011**

(51) **LOC (9) Cl.** **02-07**

(52) **U.S. Cl.** **D11/218**

(58) **Field of Classification Search** D11/1-2,
D11/200-201, 206-210, 214-218; 24/163 R,
24/169-171, 173, 177-179, 191, 194-195,
24/197, 200

See application file for complete search history.

(56) **References Cited**

U.S. PATENT DOCUMENTS

D21,860	S	*	9/1892	Shillitto	D11/218
2,119,469	A	*	5/1938	Kerngood	24/200
2,412,895	A	*	12/1946	Lewis	24/265 H
4,005,904	A	*	2/1977	Weman et al.	297/483
D357,435	S	*	4/1995	Cook	D11/218
D470,793	S	*	2/2003	Horn et al.	D11/200
D519,410	S	*	4/2006	Luk	D11/218
D626,450	S		11/2010	Wong		
D641,613	S	*	7/2011	Isberner	D8/383

* cited by examiner

Primary Examiner — Ralf Seifert

(57) **CLAIM**

The ornamental design for a buckle assembly, as shown.

DESCRIPTION

FIG. 1 is a front elevational view of a buckle assembly;
FIG. 2 is a rear elevational view of the buckle assembly;

FIG. 3 is a top plan view of the buckle assembly;
FIG. 4 is a bottom plan view of the buckle assembly;
FIG. 5 is a left side view of the buckle assembly;
FIG. 6 is a right side view of the buckle assembly;
FIG. 7 is a perspective view of the buckle assembly;
FIG. 8 is a front elevational view of a first part of the buckle assembly;
FIG. 9 is a rear elevational view of the first part of the buckle assembly;
FIG. 10 is a top plan view of the first part of the buckle assembly;
FIG. 11 is a bottom plan view of the first part of the buckle assembly;
FIG. 12 is a left side view of the first part of the buckle assembly;
FIG. 13 is a right side view of the first part of the buckle assembly;
FIG. 14 is a perspective view of the first part of the buckle assembly;
FIG. 15 is a front elevational view of a second part of the buckle assembly;
FIG. 16 is a rear elevational view of the second part of the buckle assembly;
FIG. 17 is a top plan view of the second part of the buckle assembly;
FIG. 18 is a bottom plan view of the second part of the buckle assembly;
FIG. 19 is a left side view of the second part of the buckle assembly;
FIG. 20 is a right side view of the second part of the buckle assembly; and,
FIG. 21 is a perspective view of the second part of the buckle assembly.

1 Claim, 12 Drawing Sheets

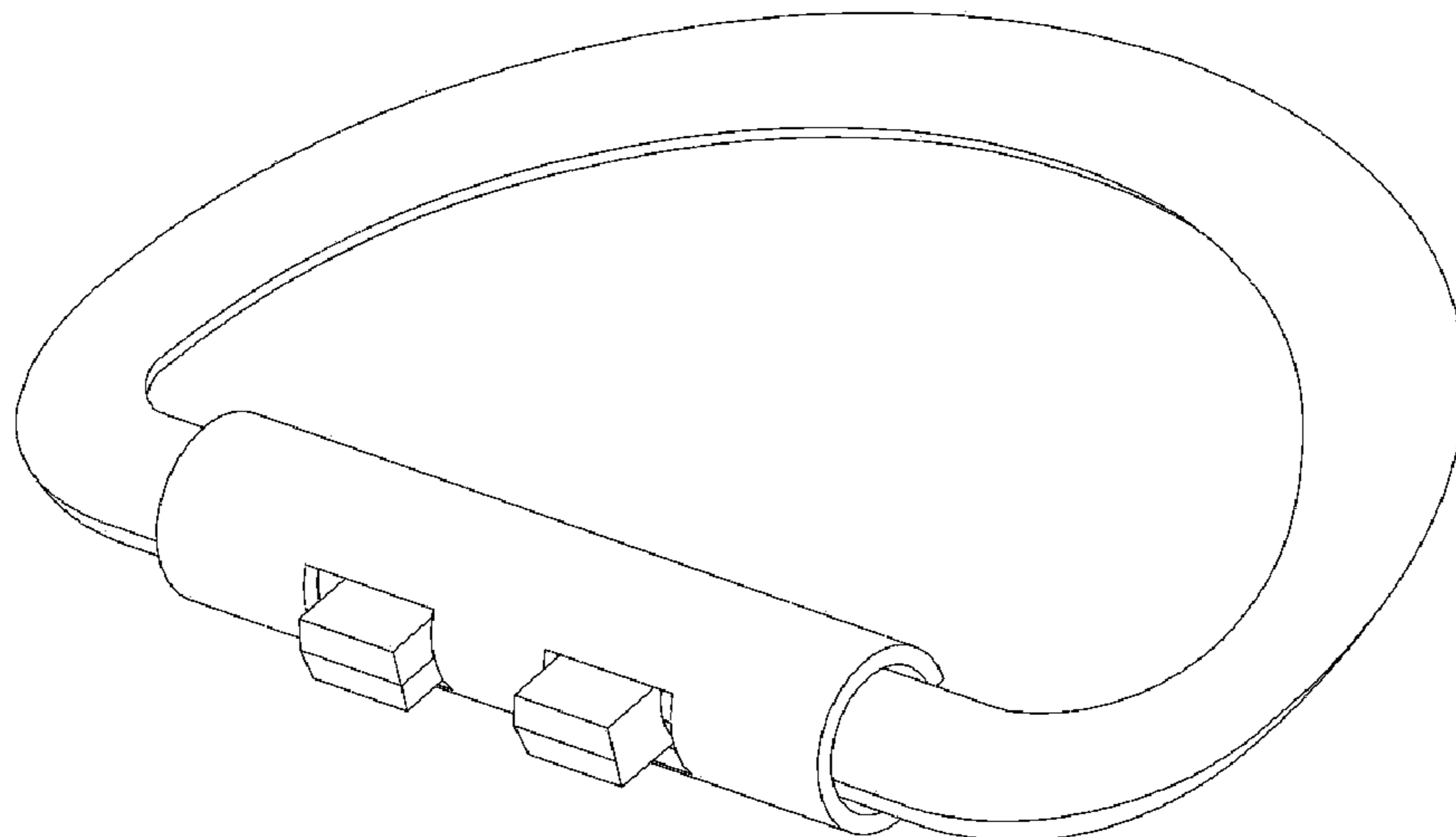

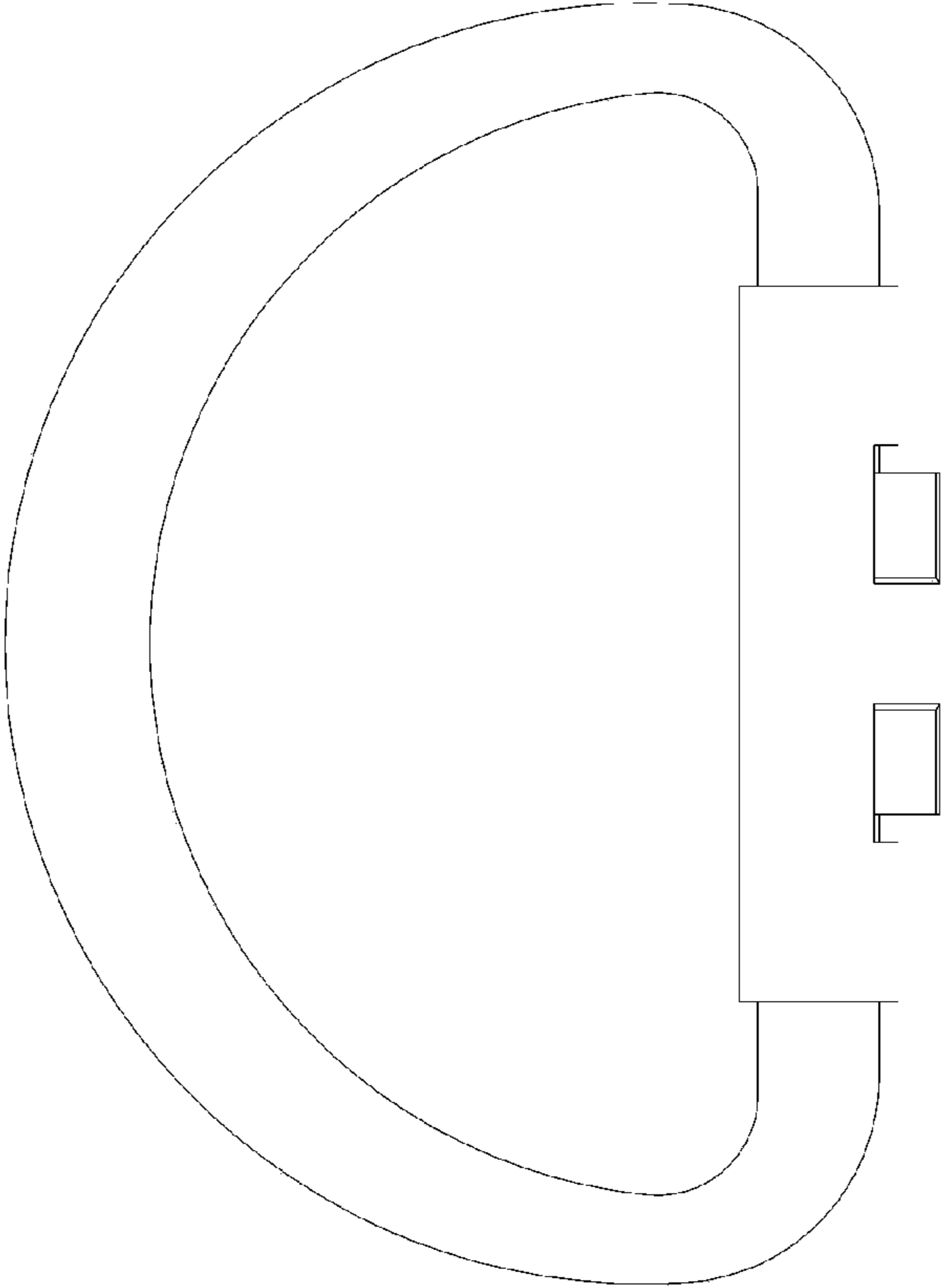

FIG. 1

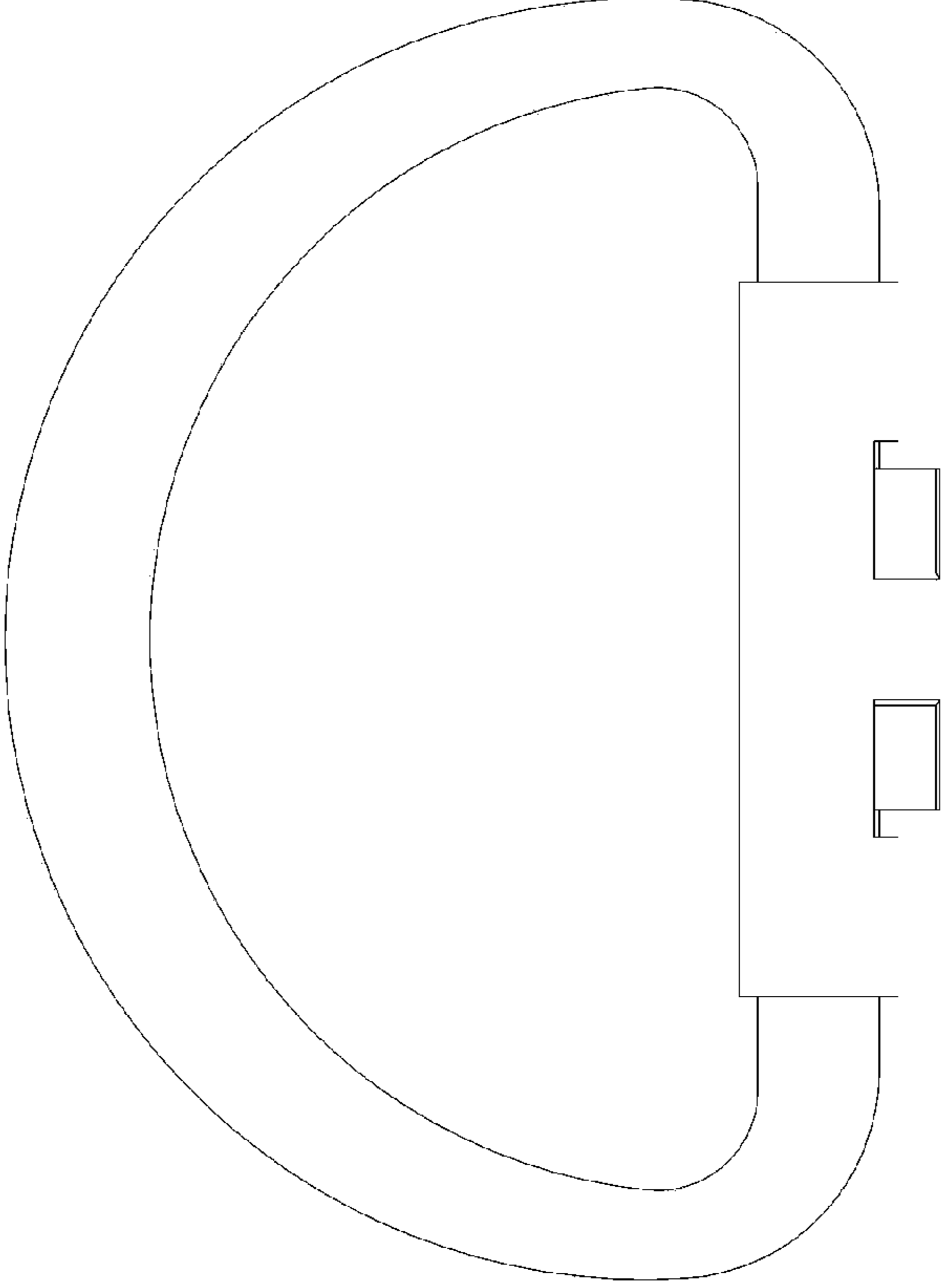

FIG. 2

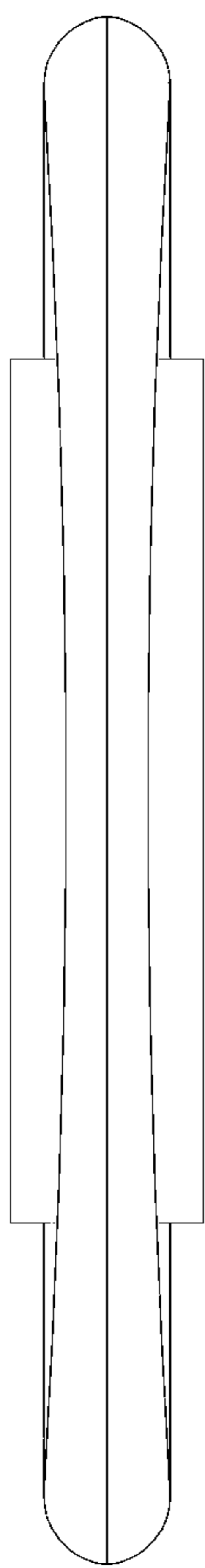

FIG. 3

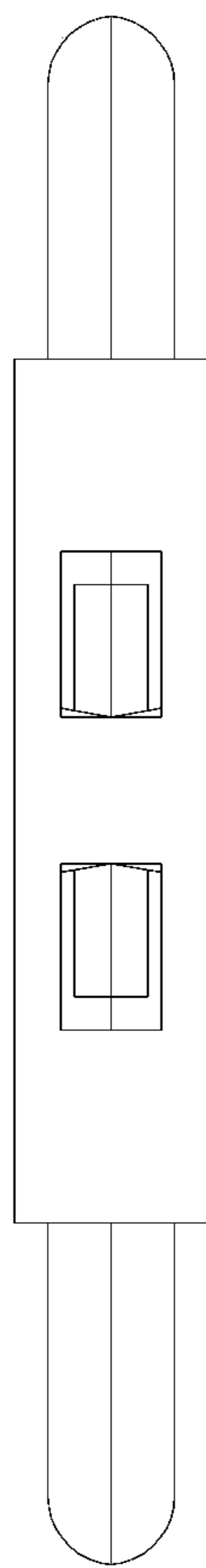

FIG. 4

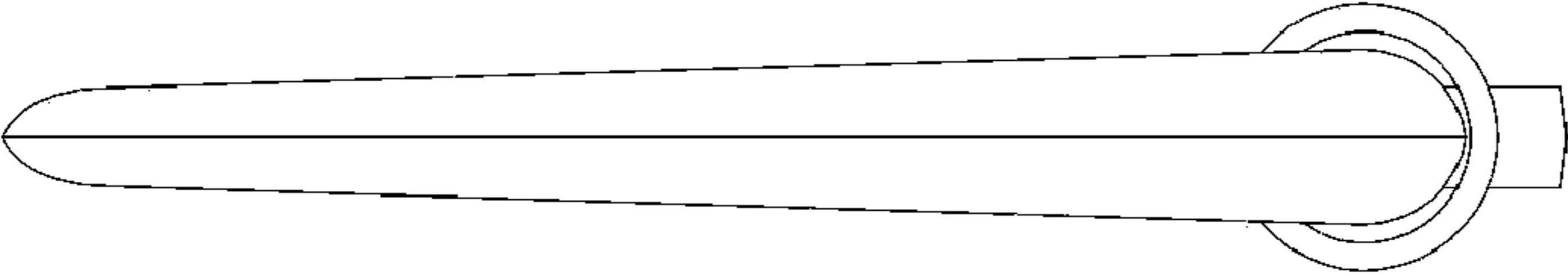

FIG. 6

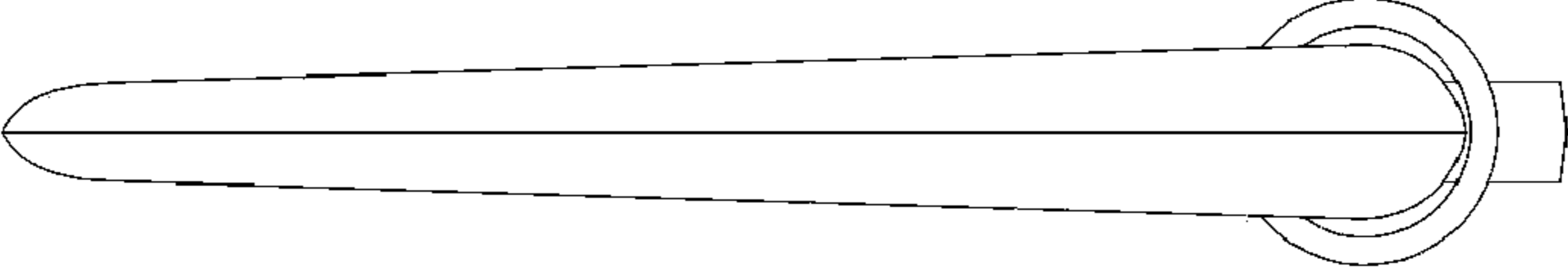

FIG. 5

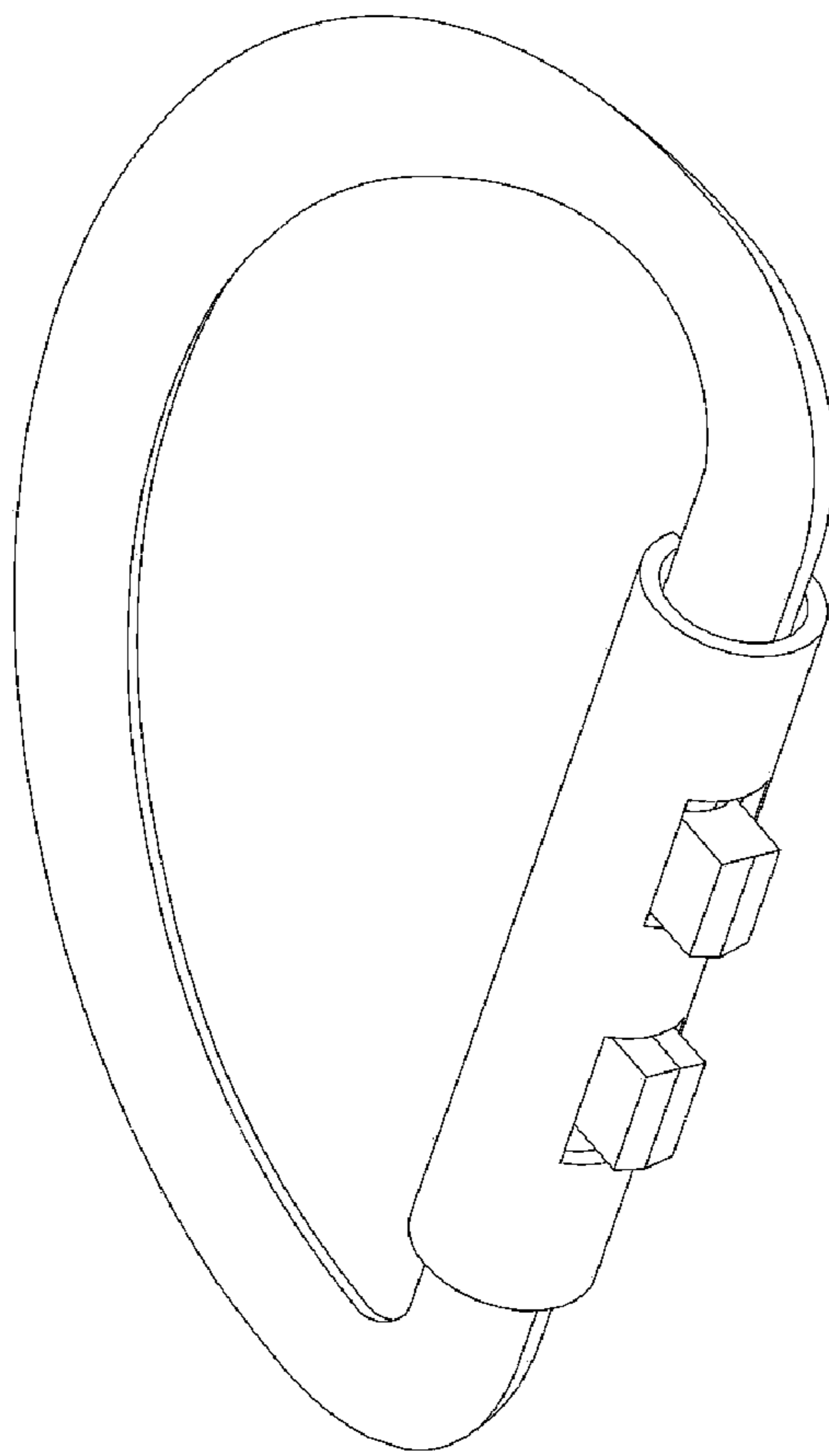

FIG. 7

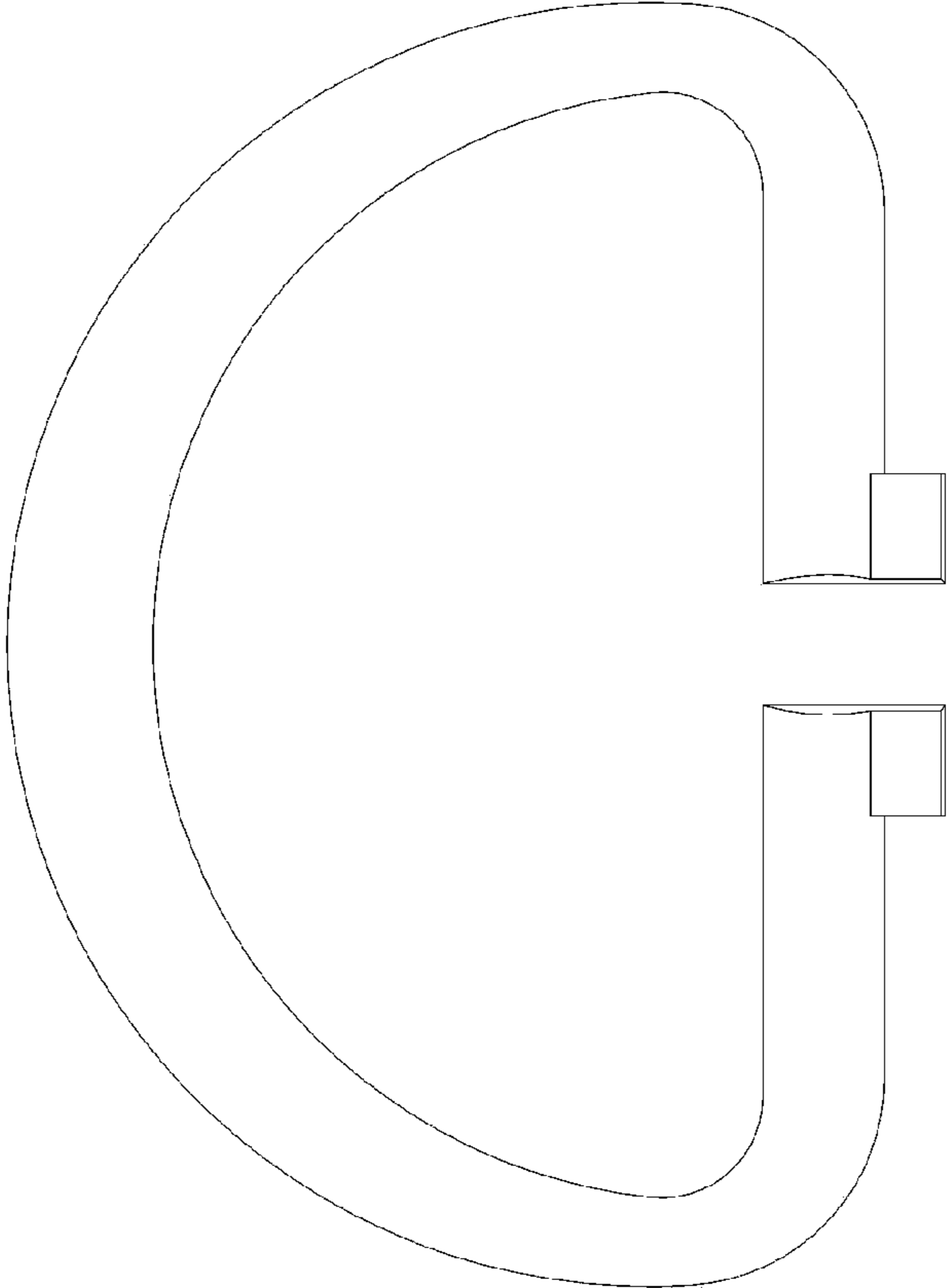

FIG. 9

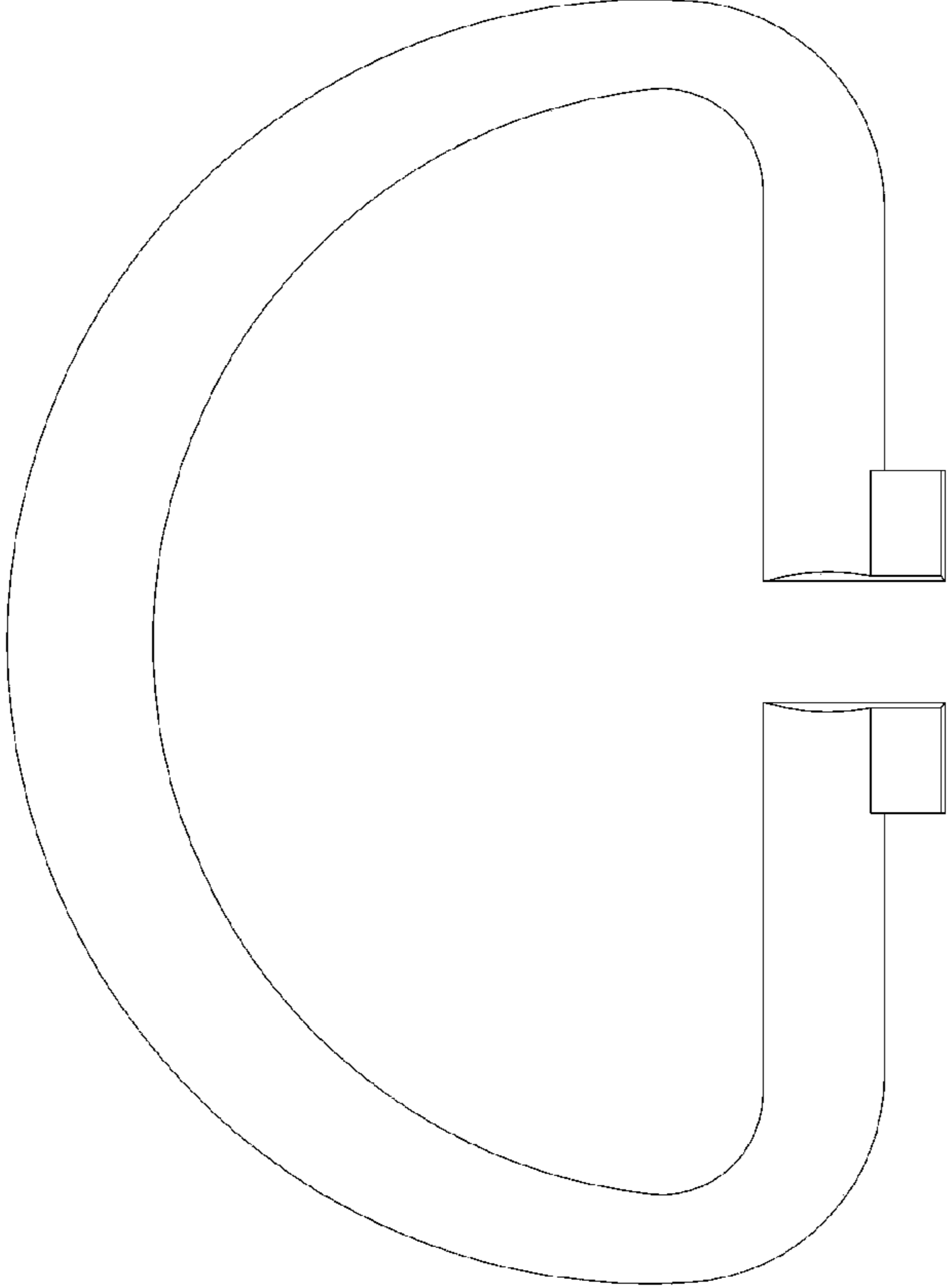

FIG. 8

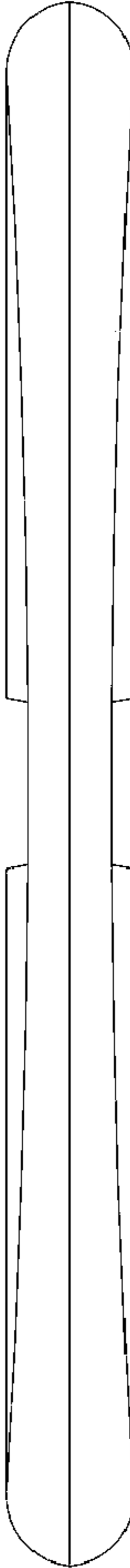

FIG. 10

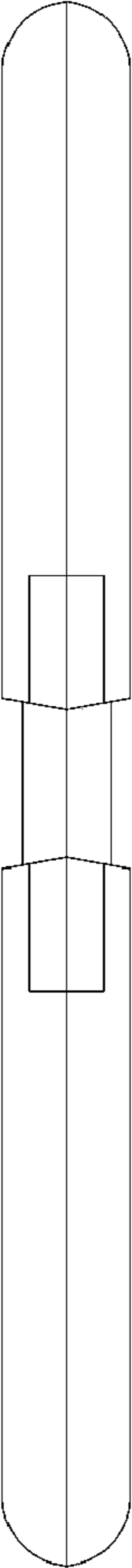

FIG. 11



FIG. 13

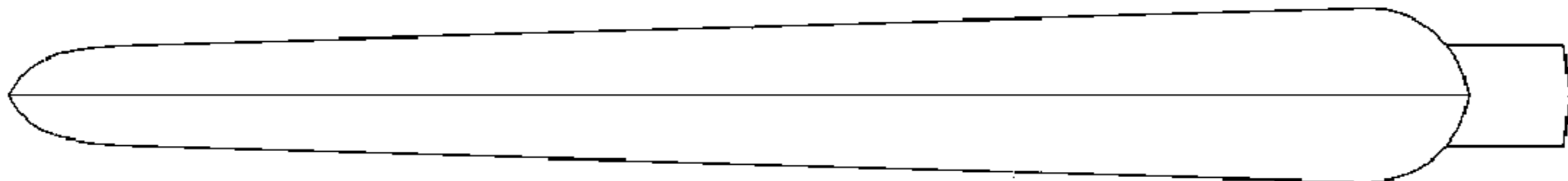

FIG. 12

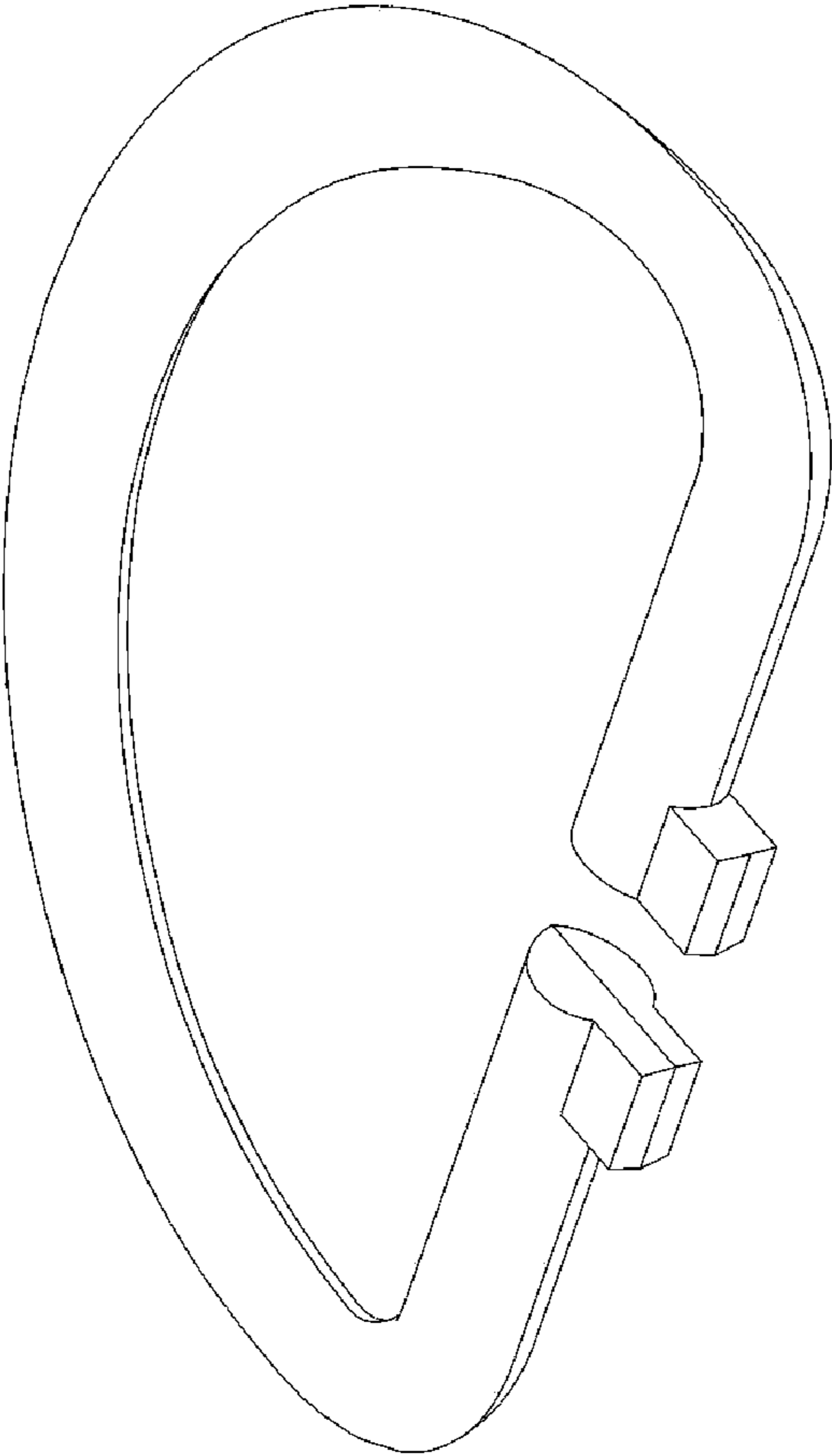

FIG. 14

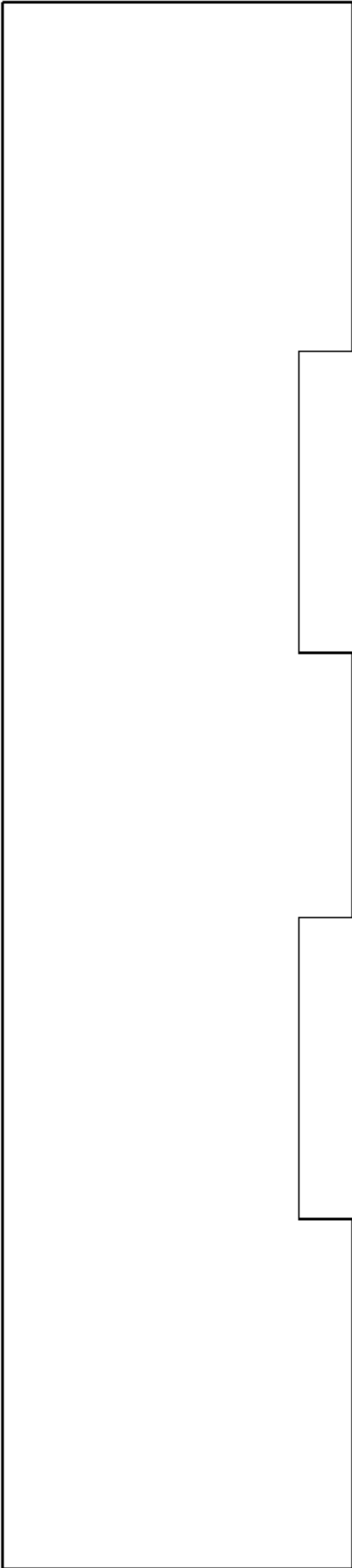

FIG. 15

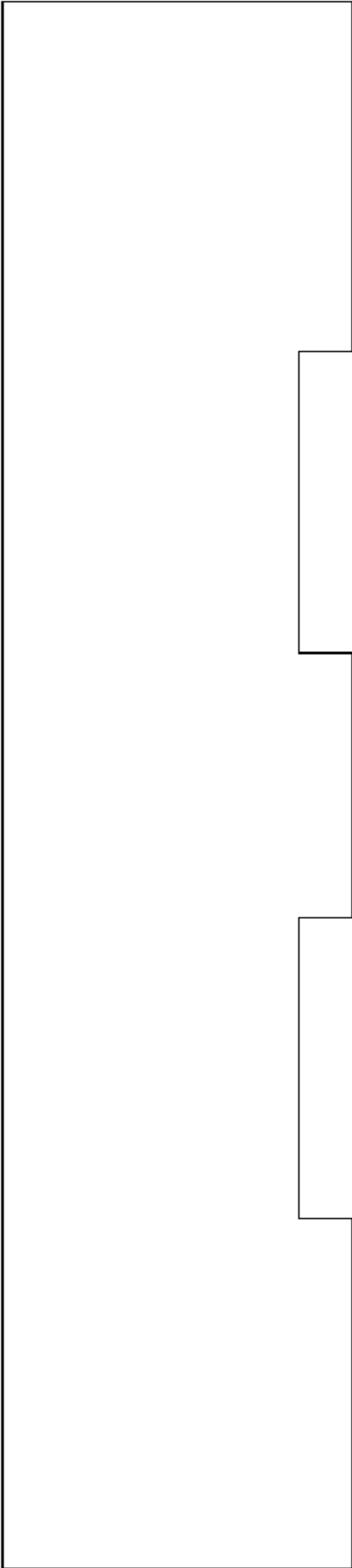

FIG. 16

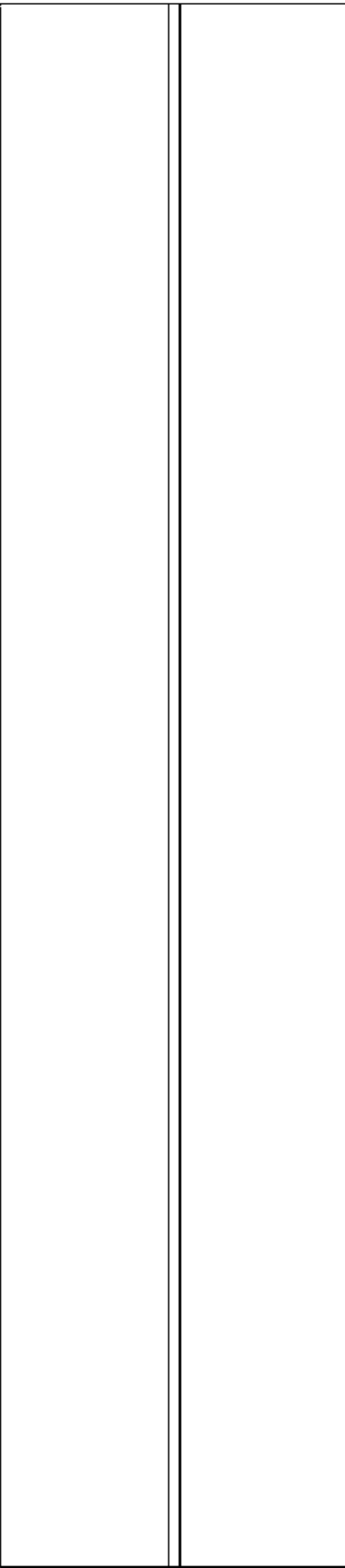

FIG. 17

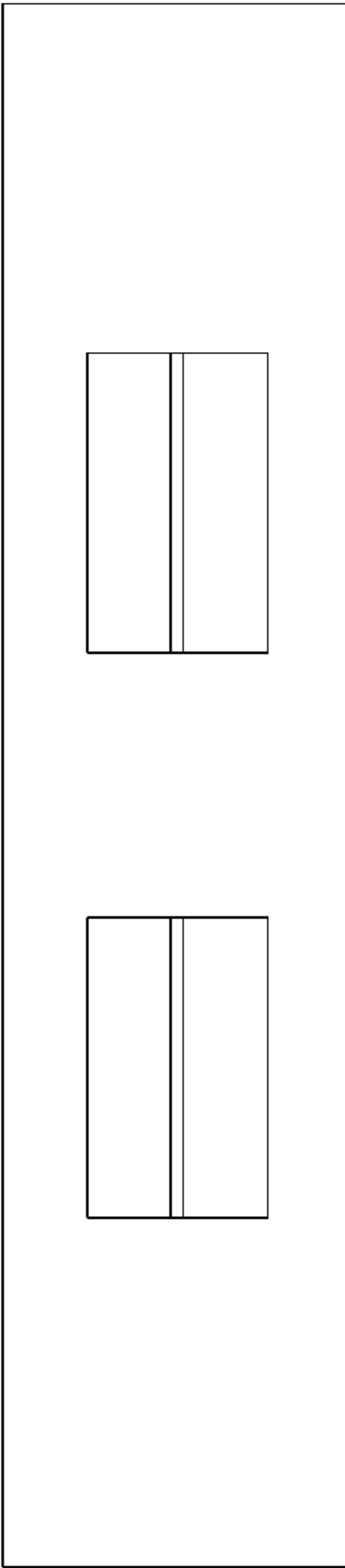

FIG. 18

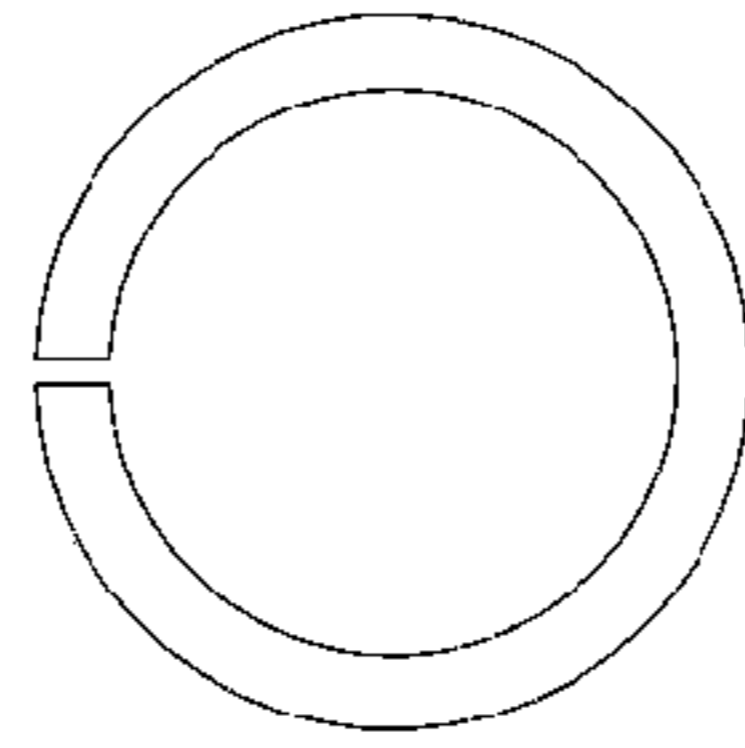

FIG. 20

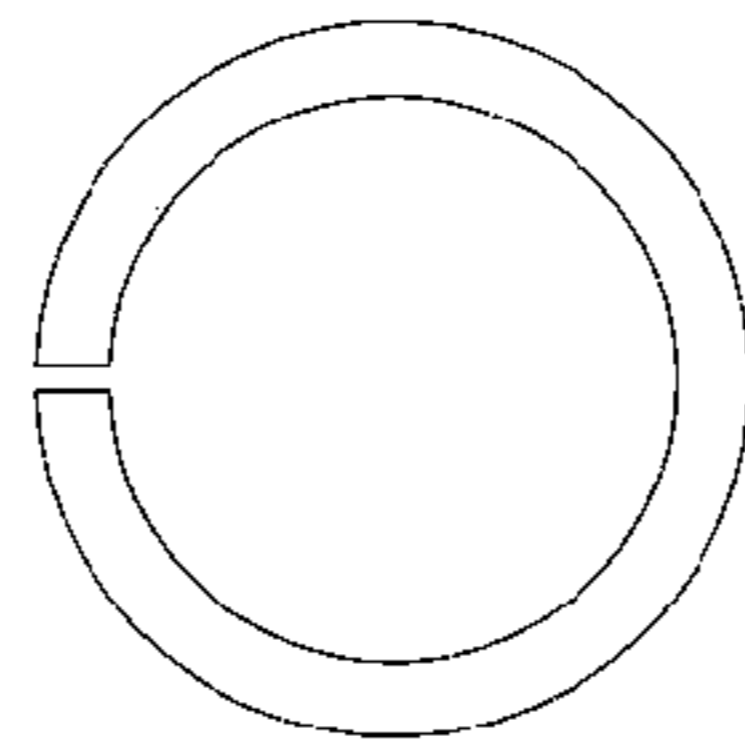

FIG. 19

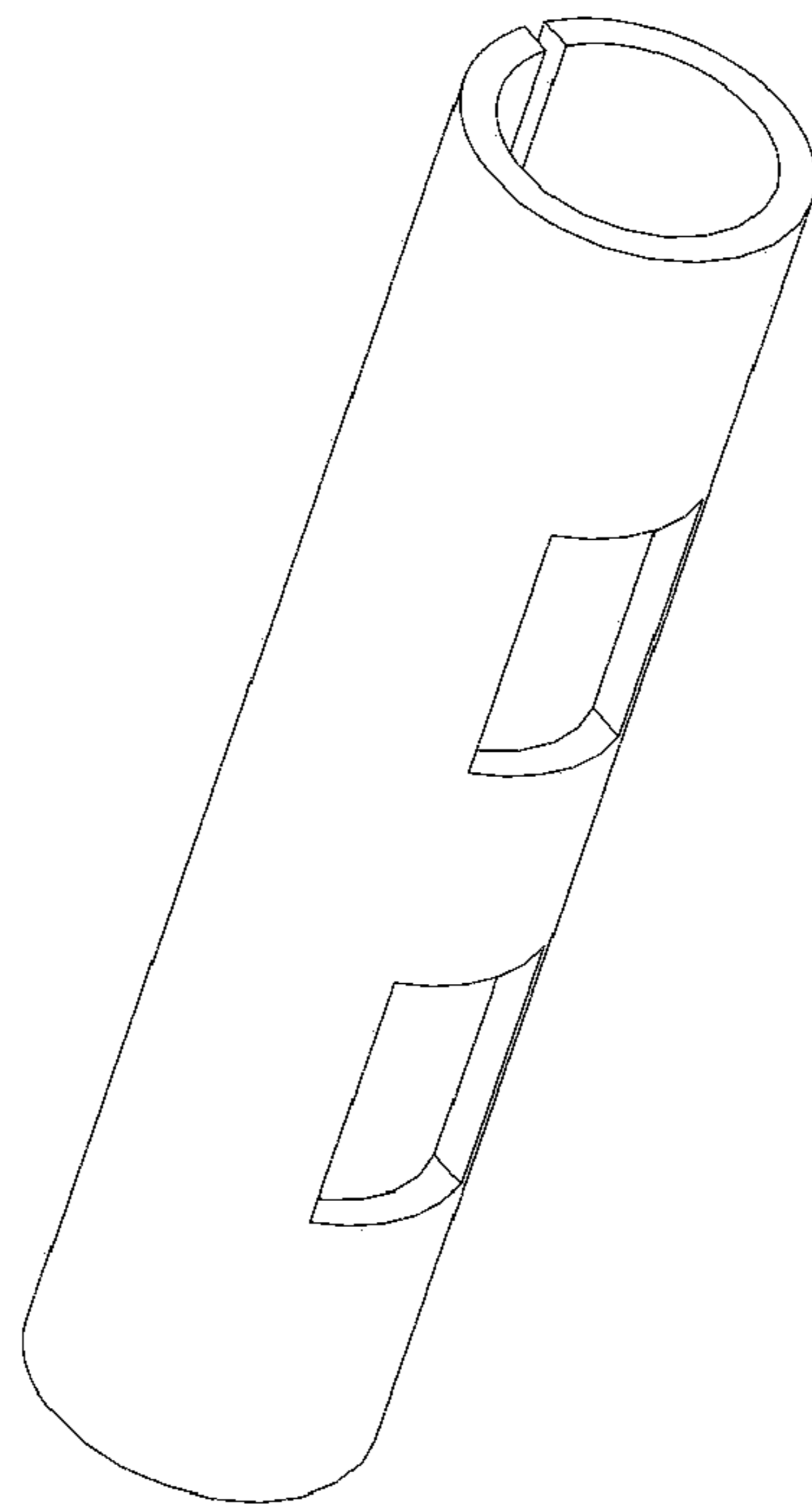

FIG. 21