



US00D654383S

(12) **United States Design Patent**
Pfrenge et al.

(10) **Patent No.:** **US D654,383 S**
(45) **Date of Patent:** **** Feb. 21, 2012**

(54) **OPTOELECTRONIC SENSORS**

(75) Inventors: **Thomas Pfrenge**, Hartheim (DE);
Bernd Deblitz, Haslach (DE)

(73) Assignee: **Sick AG**, Waldkirch (DE)

(**) Term: **14 Years**

(21) Appl. No.: **29/367,646**

(22) Filed: **Aug. 11, 2010**

(30) **Foreign Application Priority Data**

Feb. 16, 2010 (EM) 001670647

(51) **LOC (9) Cl.** **10-04**

(52) **U.S. Cl.** **D10/46**

(58) **Field of Classification Search** D10/46;
250/214 R, 221, 222.1, 222.2, 227.25, 341.8,
250/574; 257/E31, 117, 81, 432-433; 340/630;
375/E1.001; 398/140; 438/123

See application file for complete search history.

(56) **References Cited**

U.S. PATENT DOCUMENTS

6,794,639 B2 * 9/2004 Lautenschlager et al. 250/239
7,009,285 B2 * 3/2006 Su et al. 257/680
D531,525 S * 11/2006 Dold et al. D10/46
D612,751 S * 3/2010 Bach et al. D10/46

* cited by examiner

Primary Examiner — Antoine D Davis

(74) *Attorney, Agent, or Firm* — The Nath Law Group;
Jerald L. Meyer; Derek Richmond

(57) **CLAIM**

We claim the ornamental design for the optoelectronic sensors, as shown.

DESCRIPTION

FIG. 1 is a left view of a first embodiment of the optoelectronic sensors;

FIG. 2 is a front view of a first embodiment of the optoelectronic sensors;

FIG. 3 is a right view of a first embodiment of the optoelectronic sensors;

FIG. 4 is a back view of a first embodiment of the optoelectronic sensors;

FIG. 5 is a bottom view of a first embodiment of the optoelectronic sensors;

FIG. 6 is a top view of a first embodiment of the optoelectronic sensors;

FIG. 7 is a perspective view of a first embodiment of the optoelectronic sensors;

FIG. 8 is a left view of a second embodiment of the optoelectronic sensors;

FIG. 9 is a front view of a second embodiment of the optoelectronic sensors;

FIG. 10 is a right view of a second embodiment of the optoelectronic sensors;

FIG. 11 is a back view of a second embodiment of the optoelectronic sensors;

FIG. 12 is a top view of a second embodiment of the optoelectronic sensors;

FIG. 13 is a bottom view of a second embodiment of the optoelectronic sensors;

FIG. 14 is a perspective view of a second embodiment of the optoelectronic sensors;

FIG. 15 is a left view of a third embodiment of the optoelectronic sensors;

FIG. 16 is a front view of a third embodiment of the optoelectronic sensors;

FIG. 17 is a right view of a third embodiment of the optoelectronic sensors;

FIG. 18 is a back view of a third embodiment of the optoelectronic sensors;

FIG. 19 is a bottom view of a third embodiment of the optoelectronic sensors;

FIG. 20 is a top view of a third embodiment of the optoelectronic sensors; and,

FIG. 21 is a perspective view of a third embodiment of the optoelectronic sensors.

1 Claim, 21 Drawing Sheets

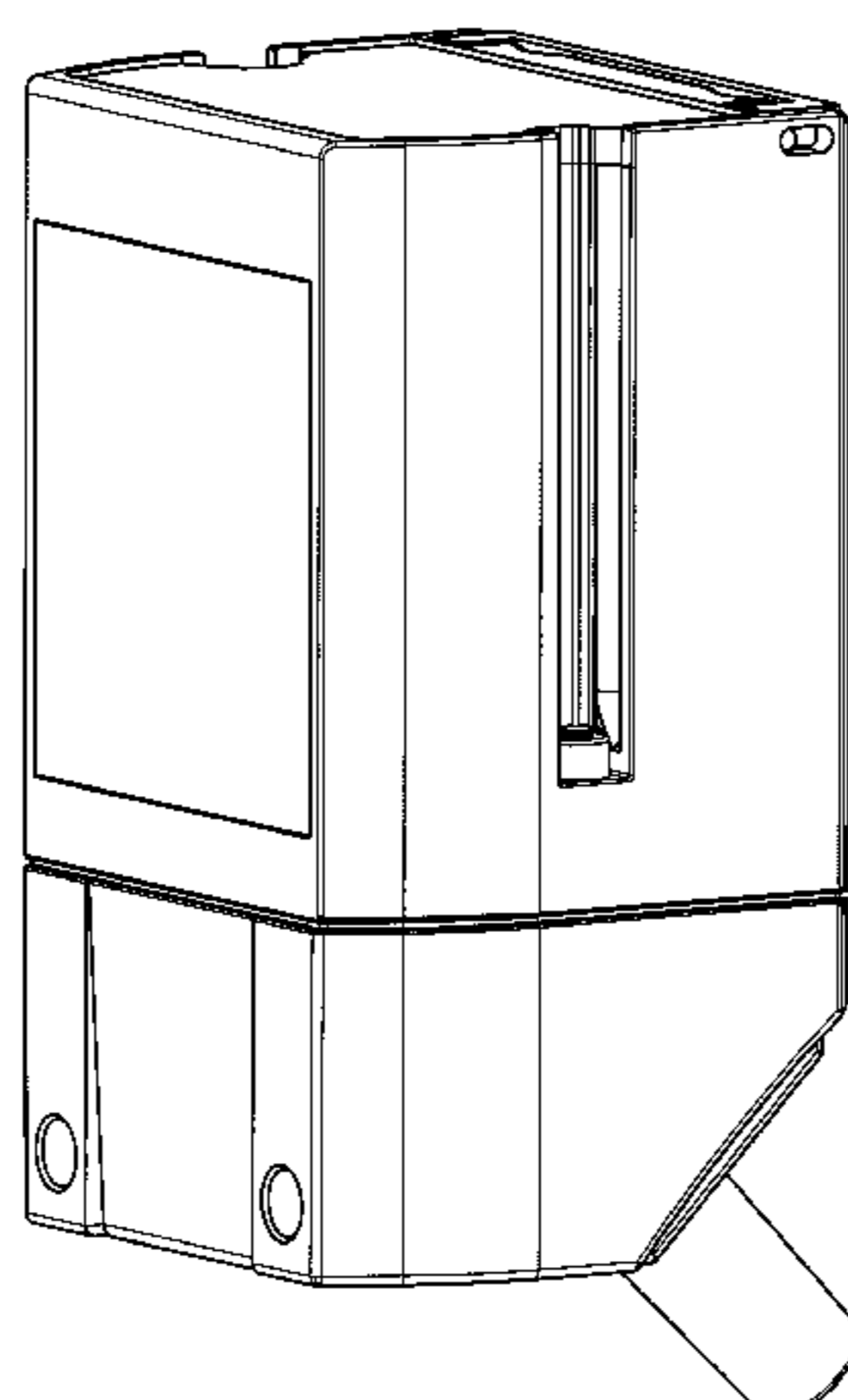

Fig. 1

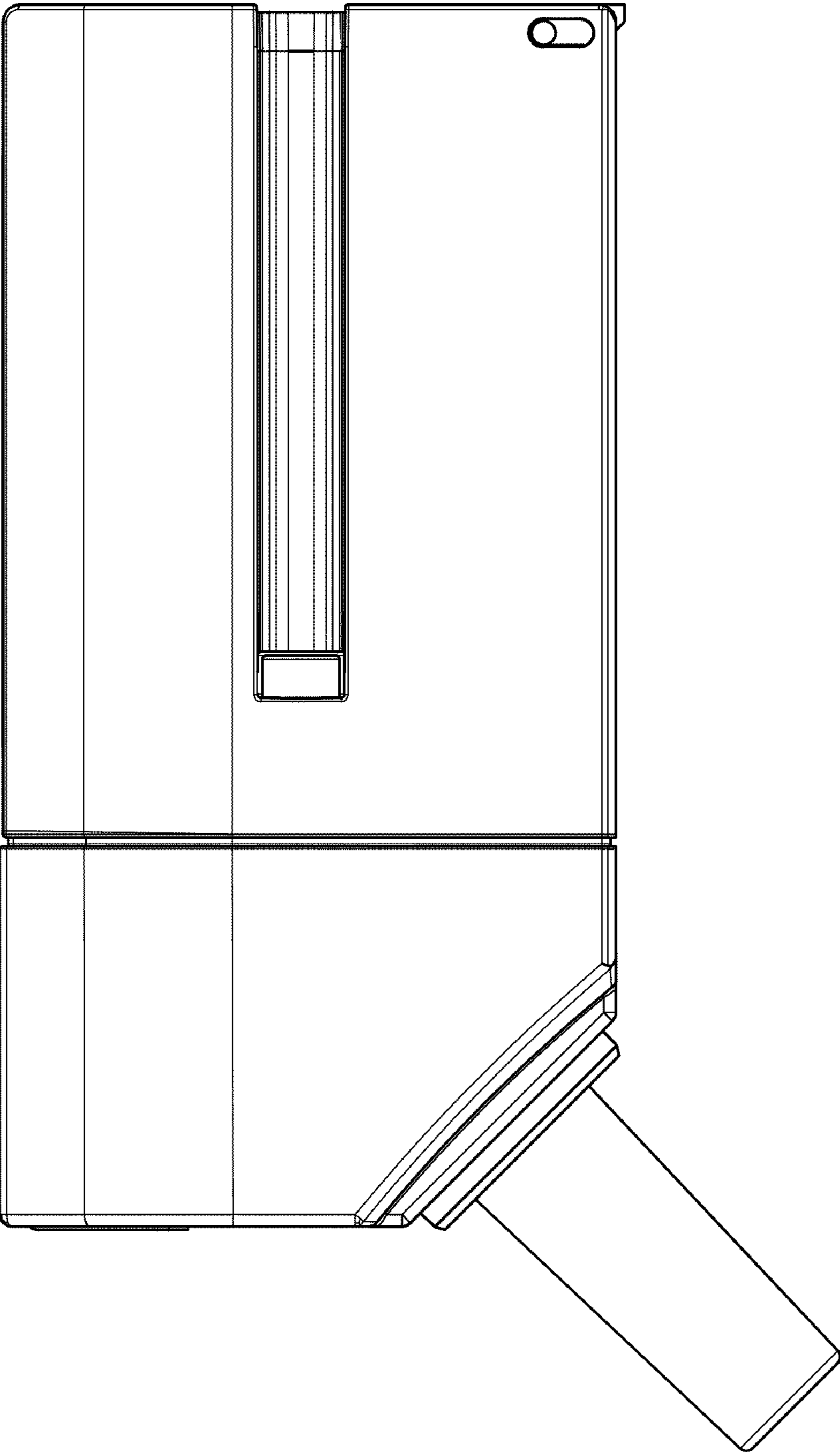

Fig. 2

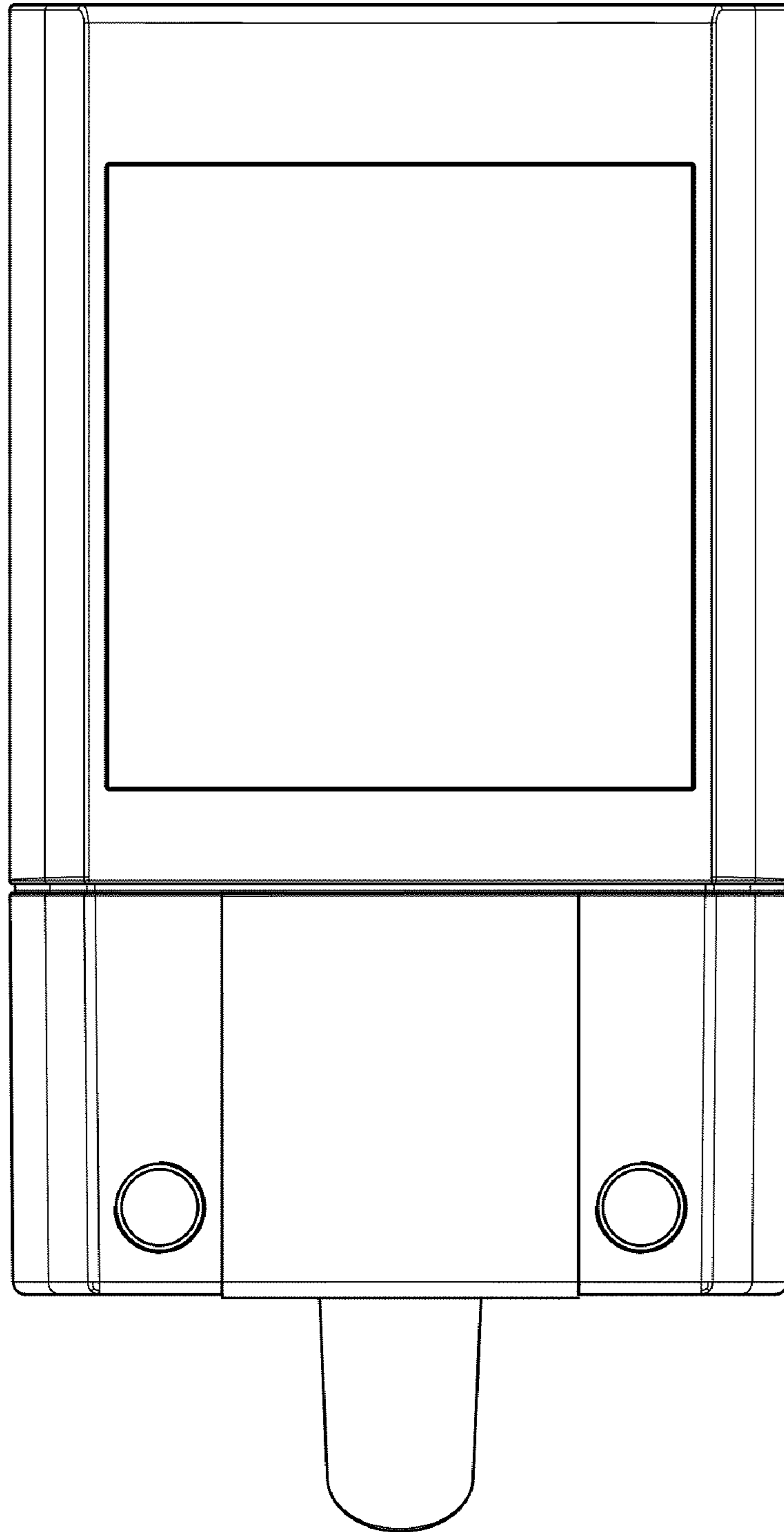

Fig. 3

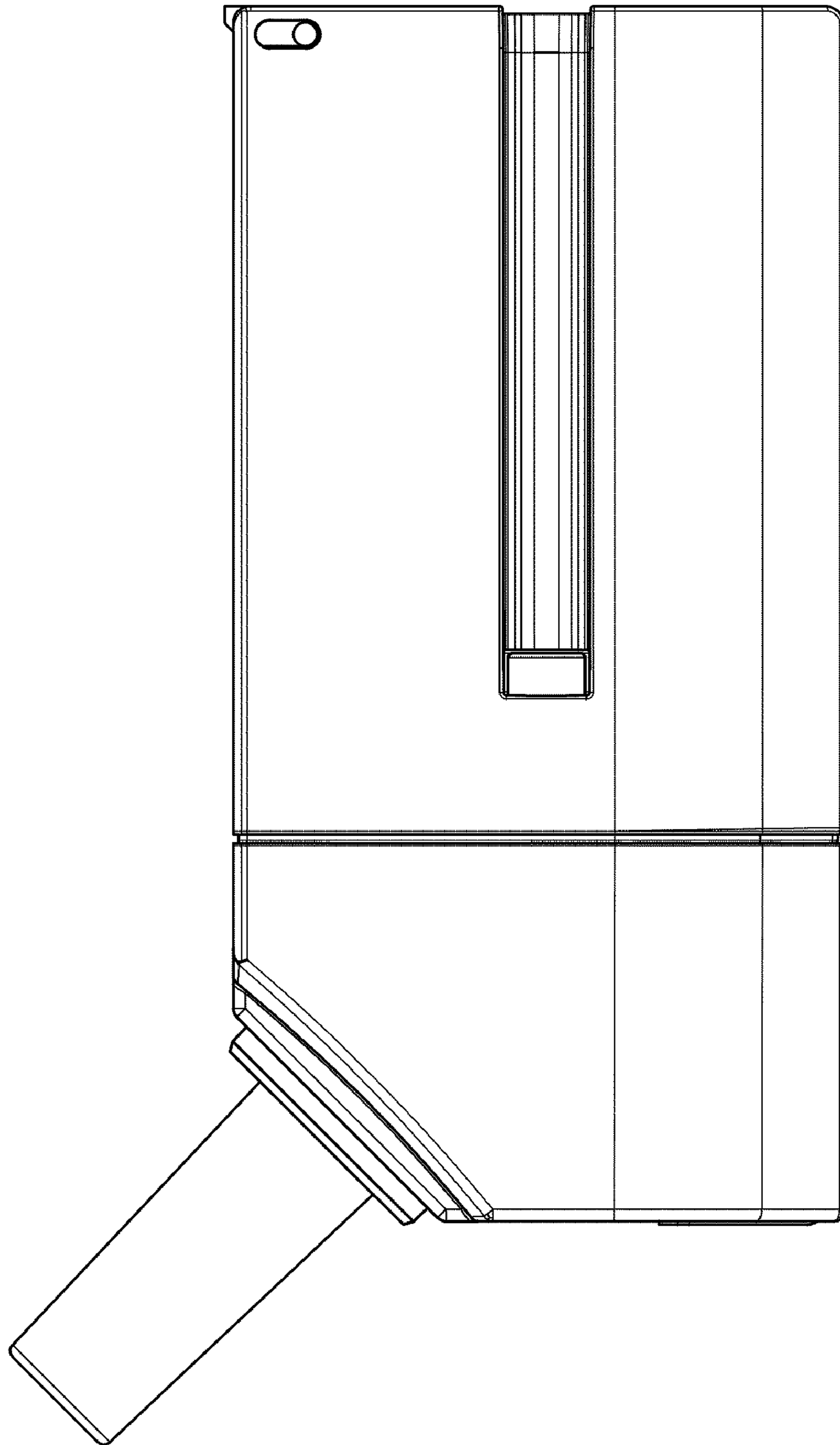

Fig. 4

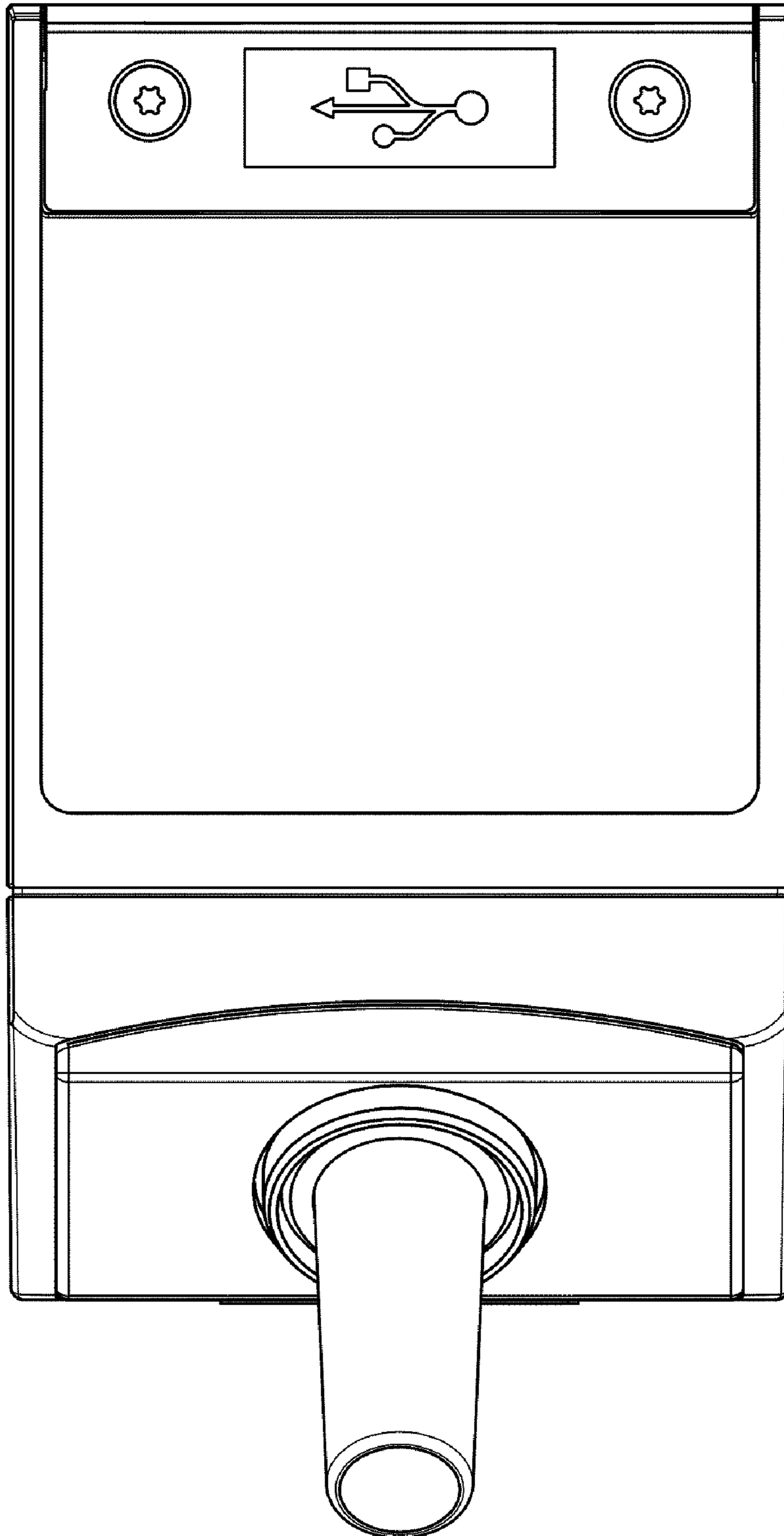

Fig. 5

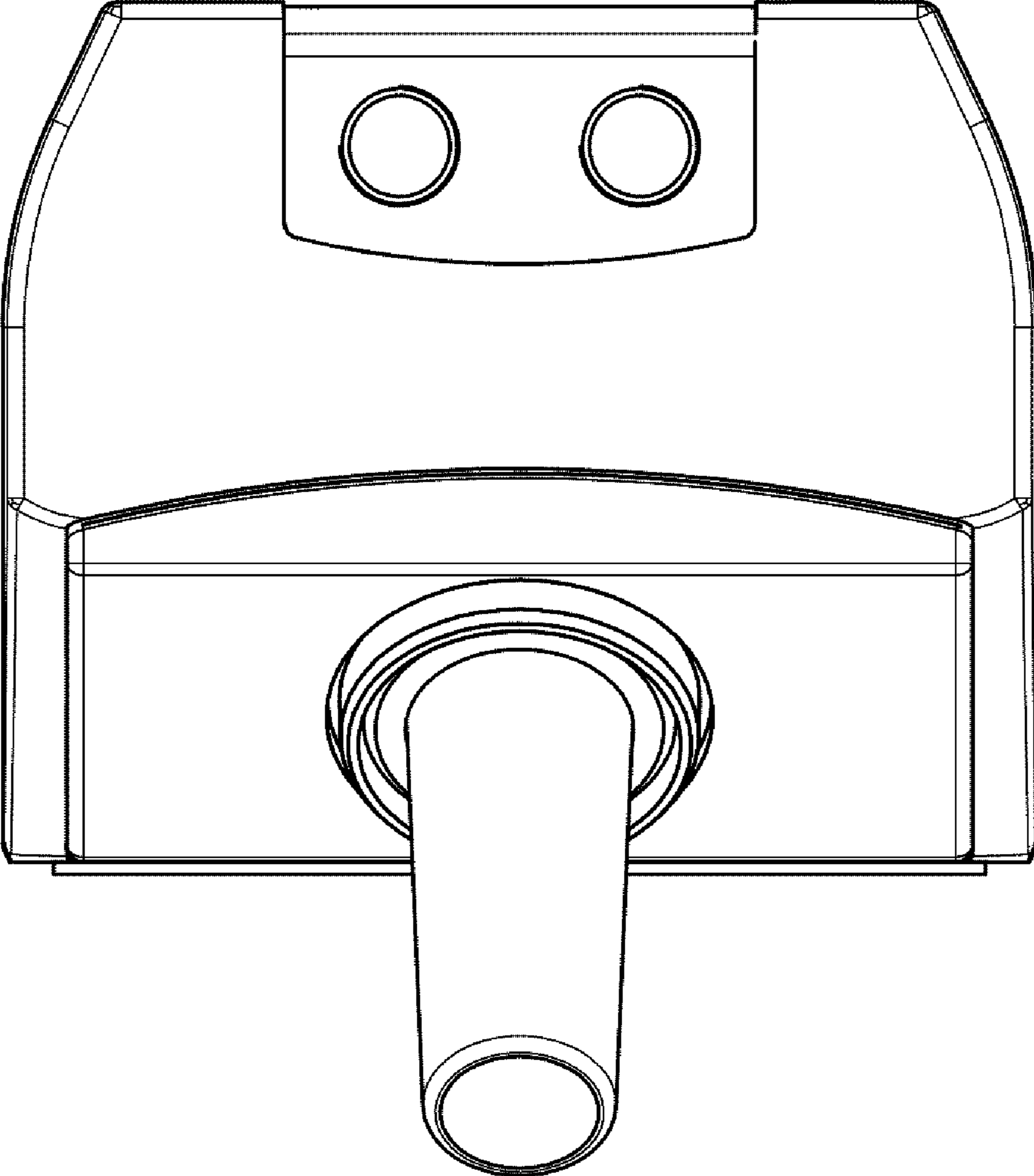

Fig. 6

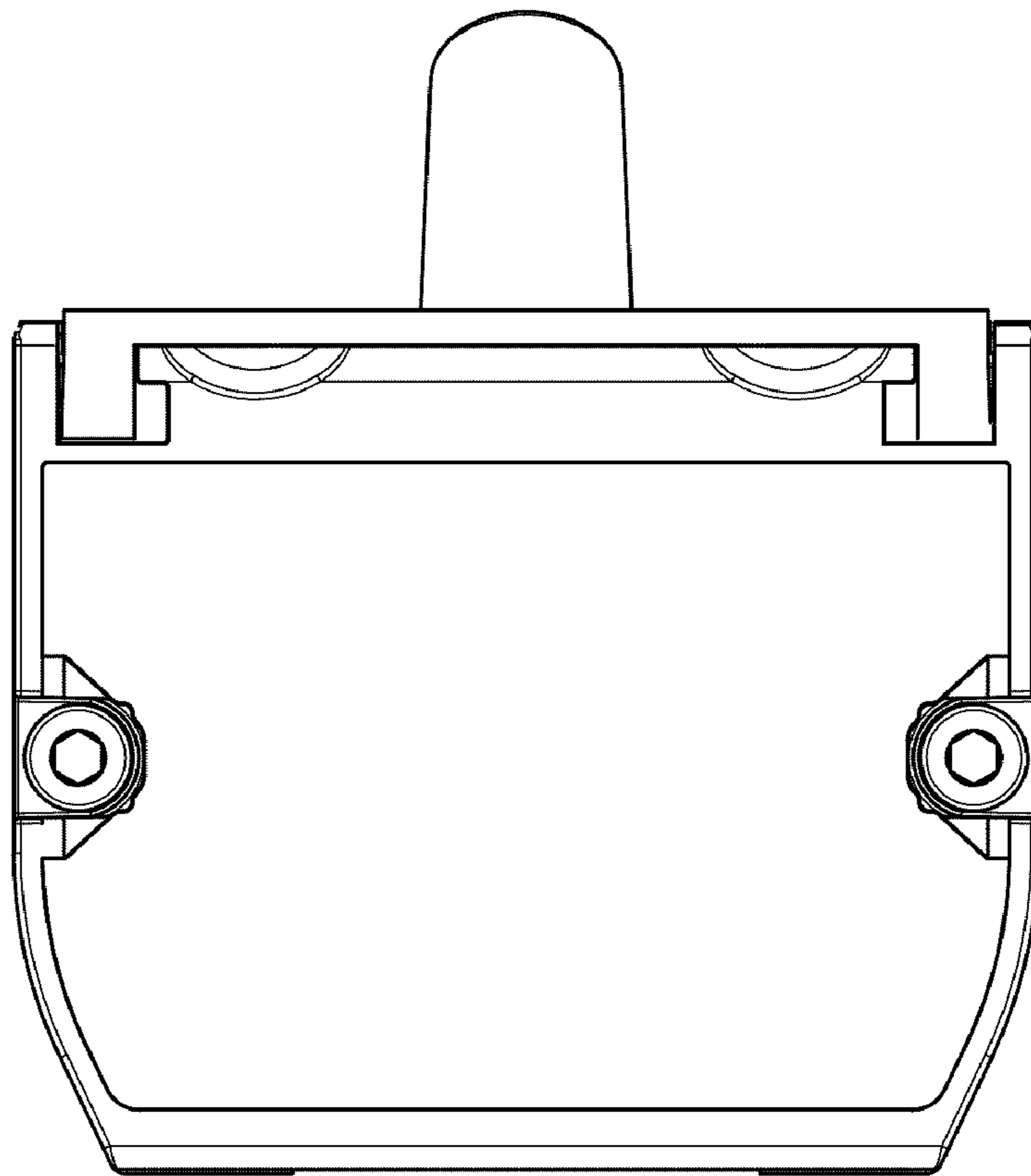

Fig. 7

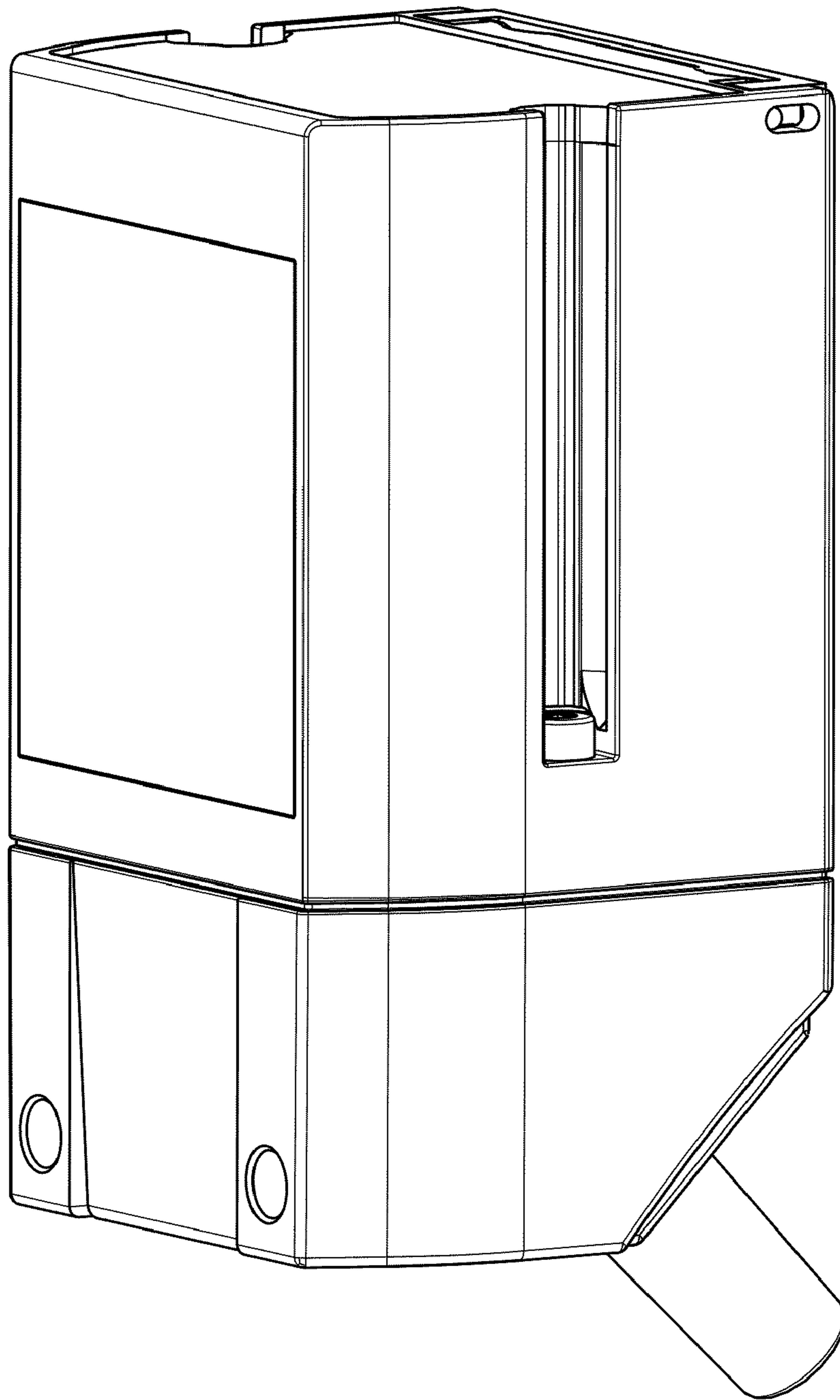

Fig. 8

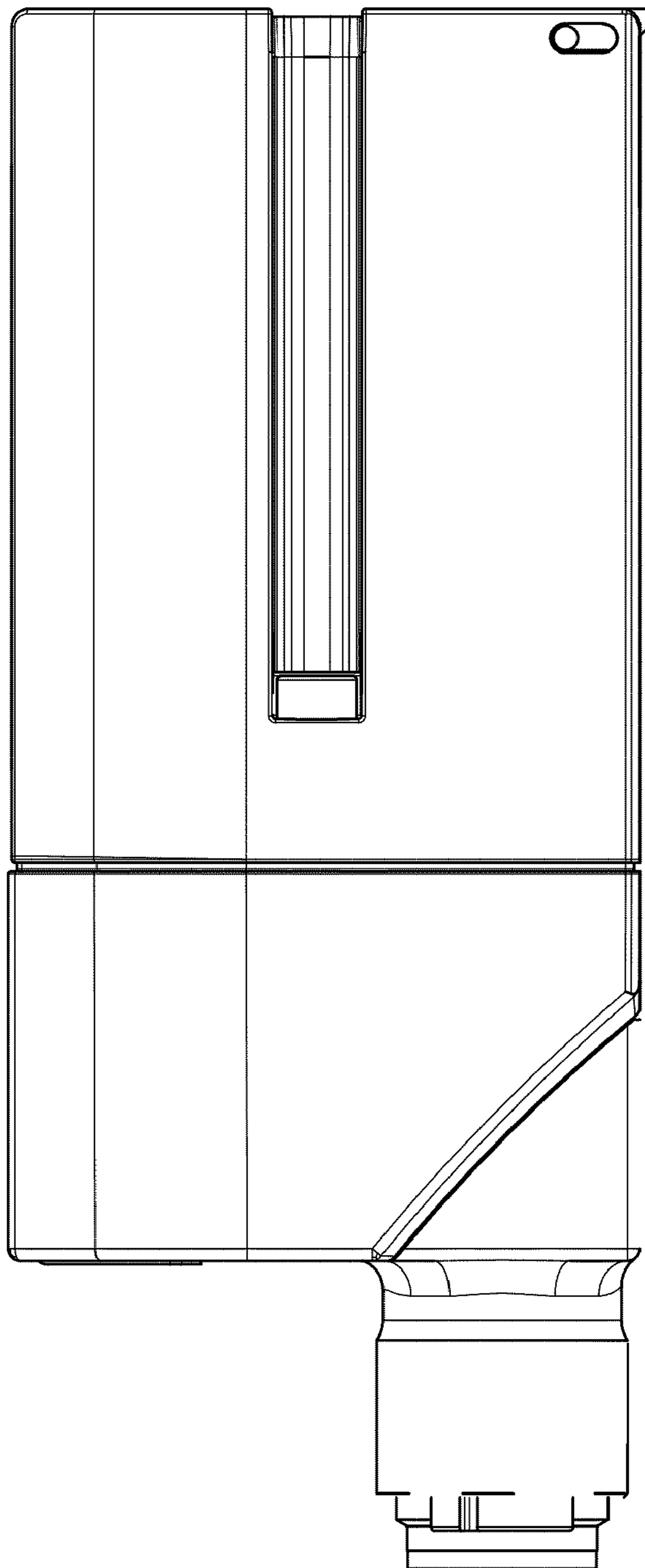

Fig. 9

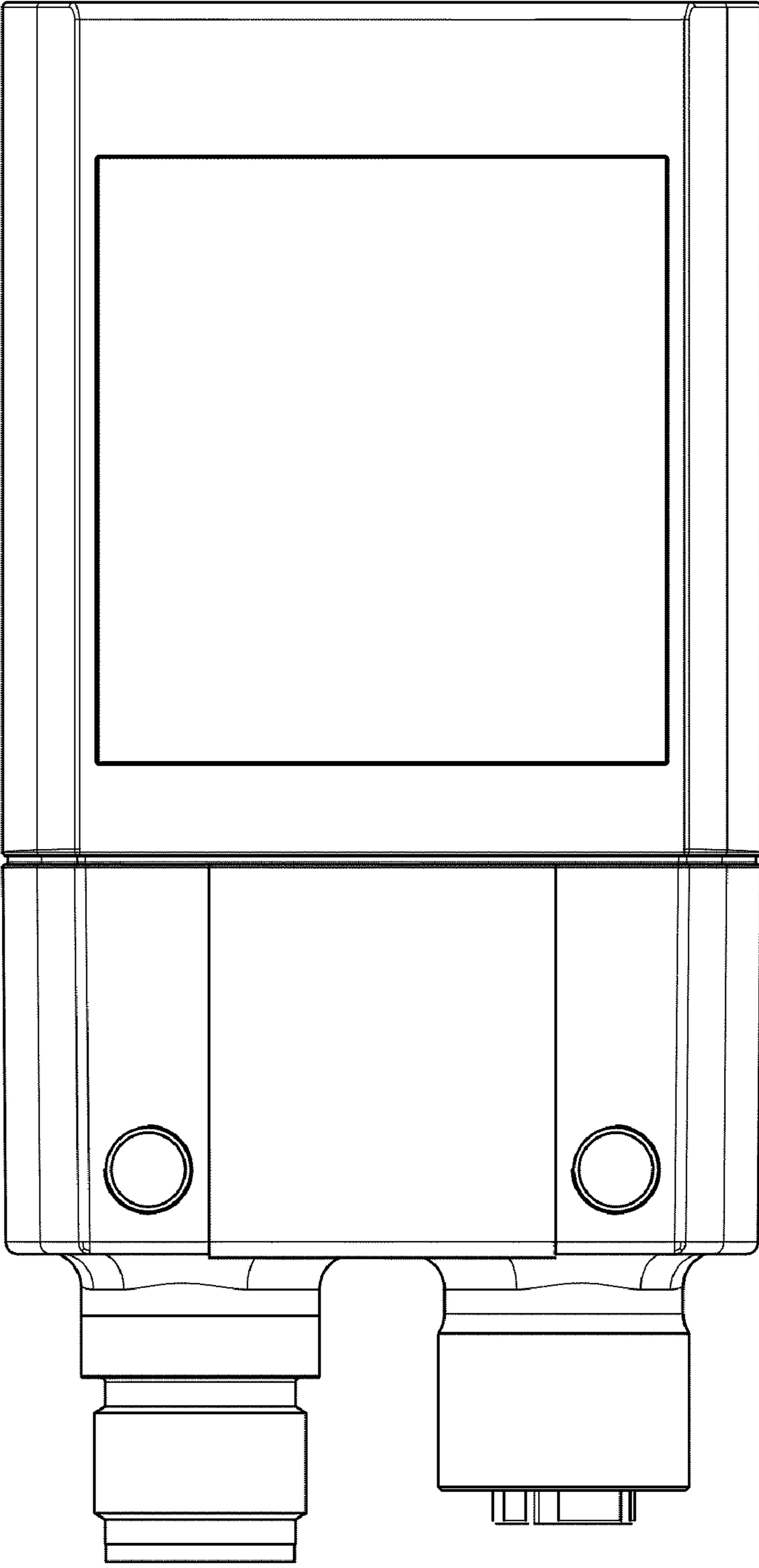

Fig. 10

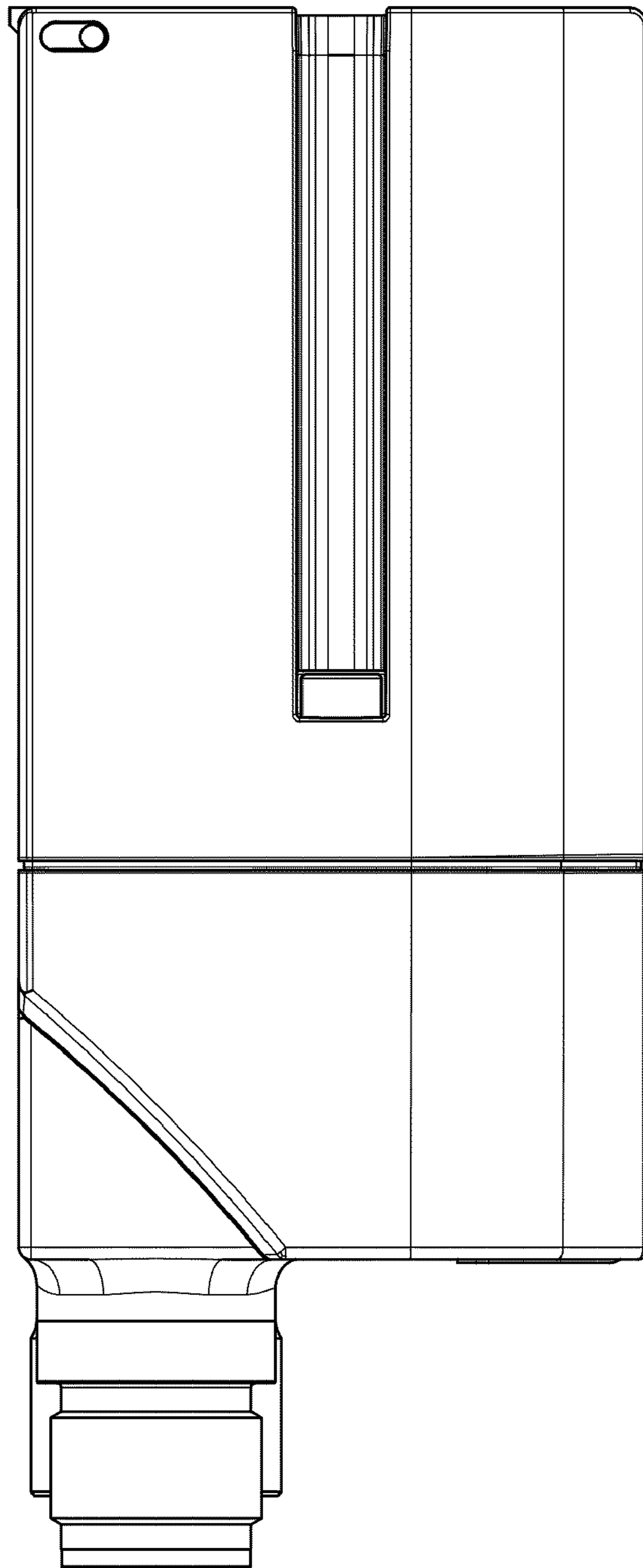

Fig. 11

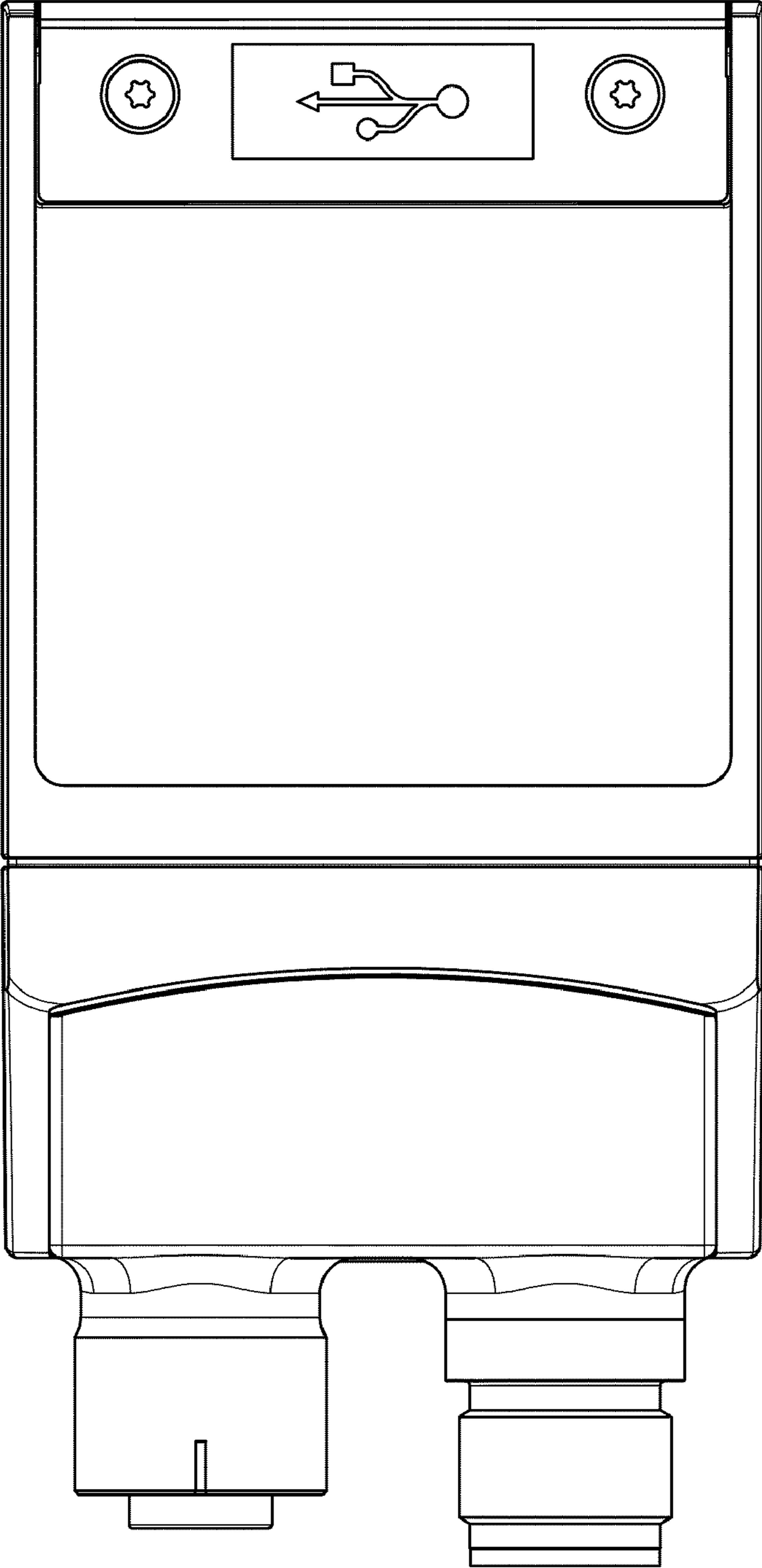

Fig. 12

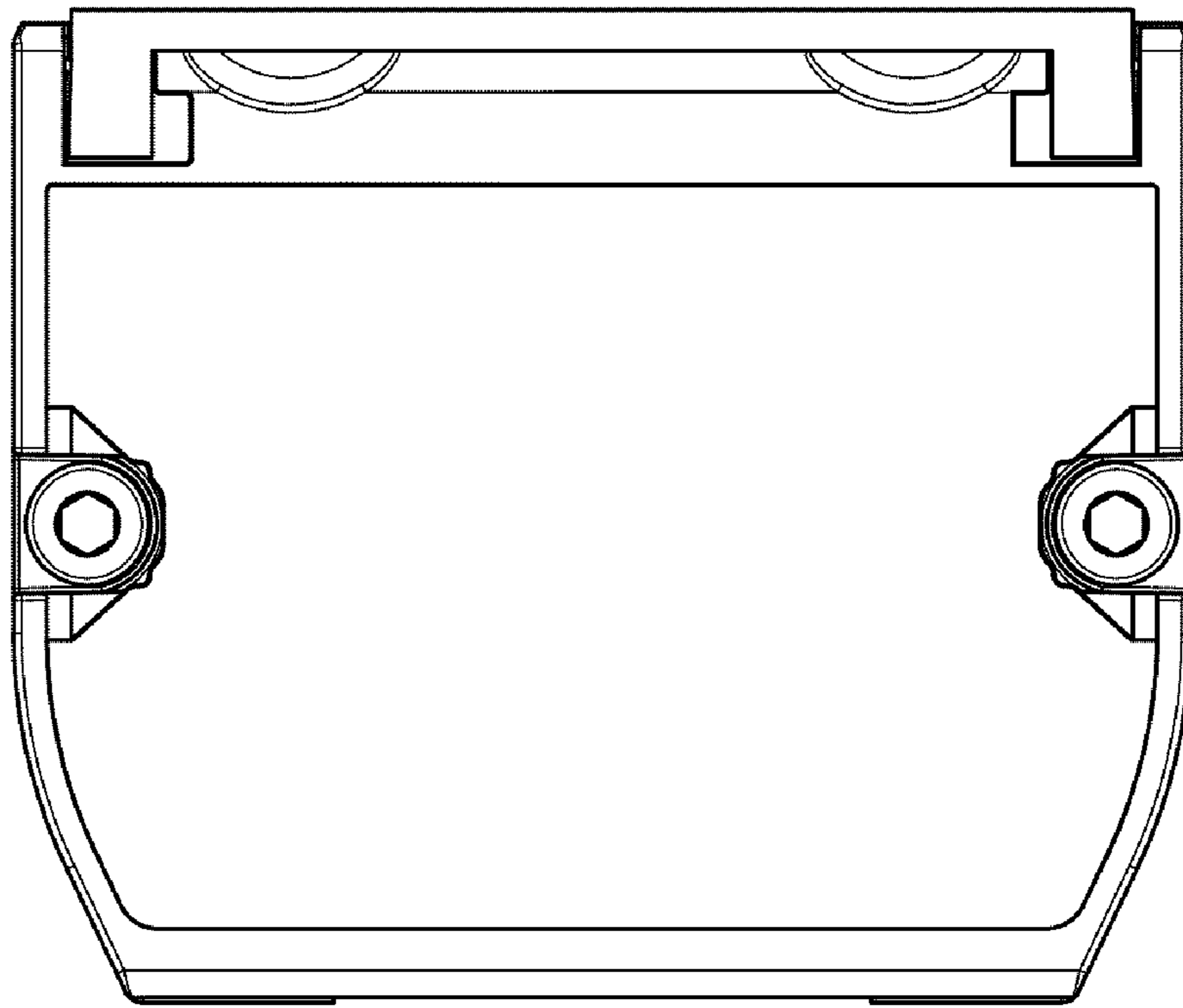

Fig. 13

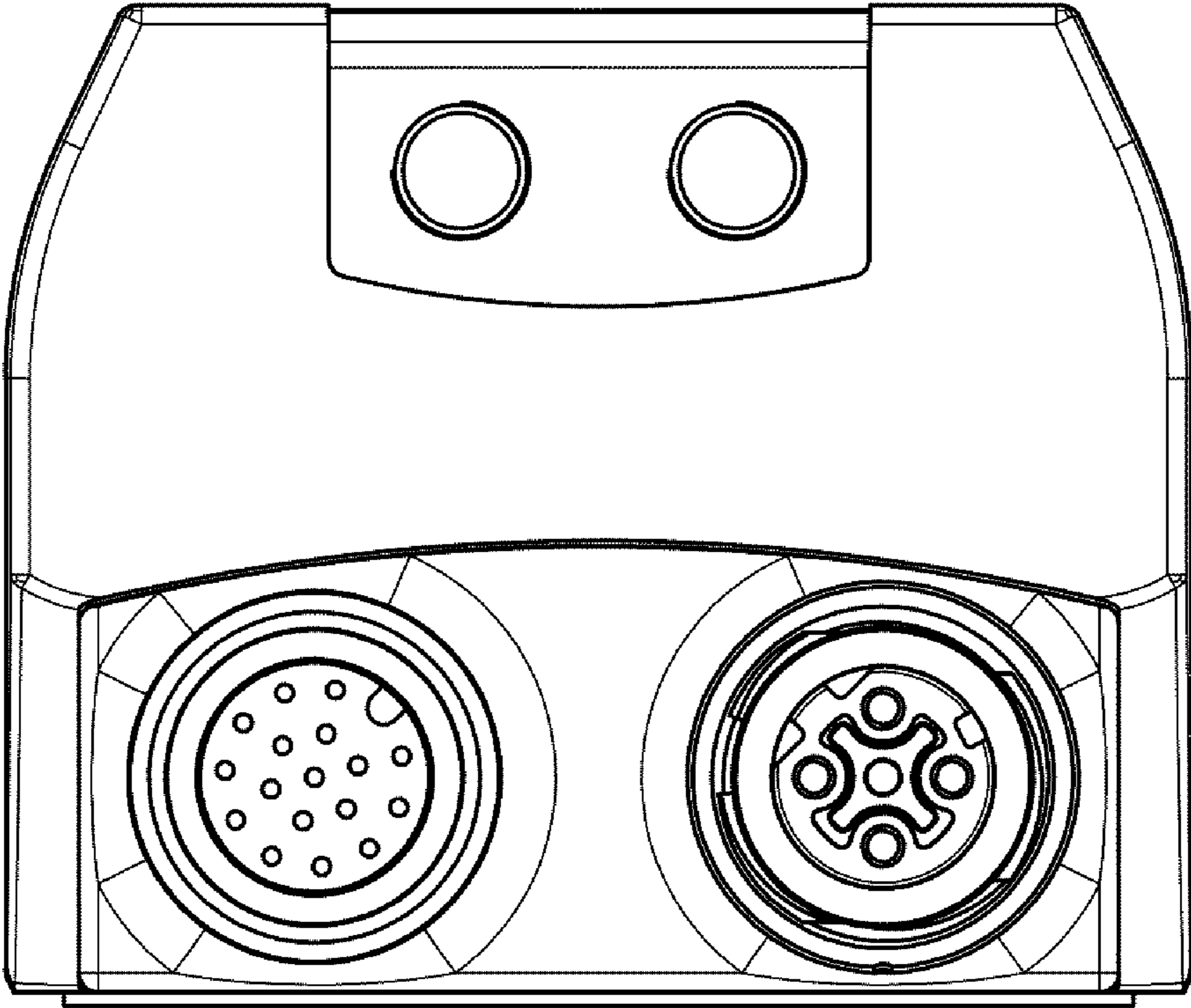

Fig. 14

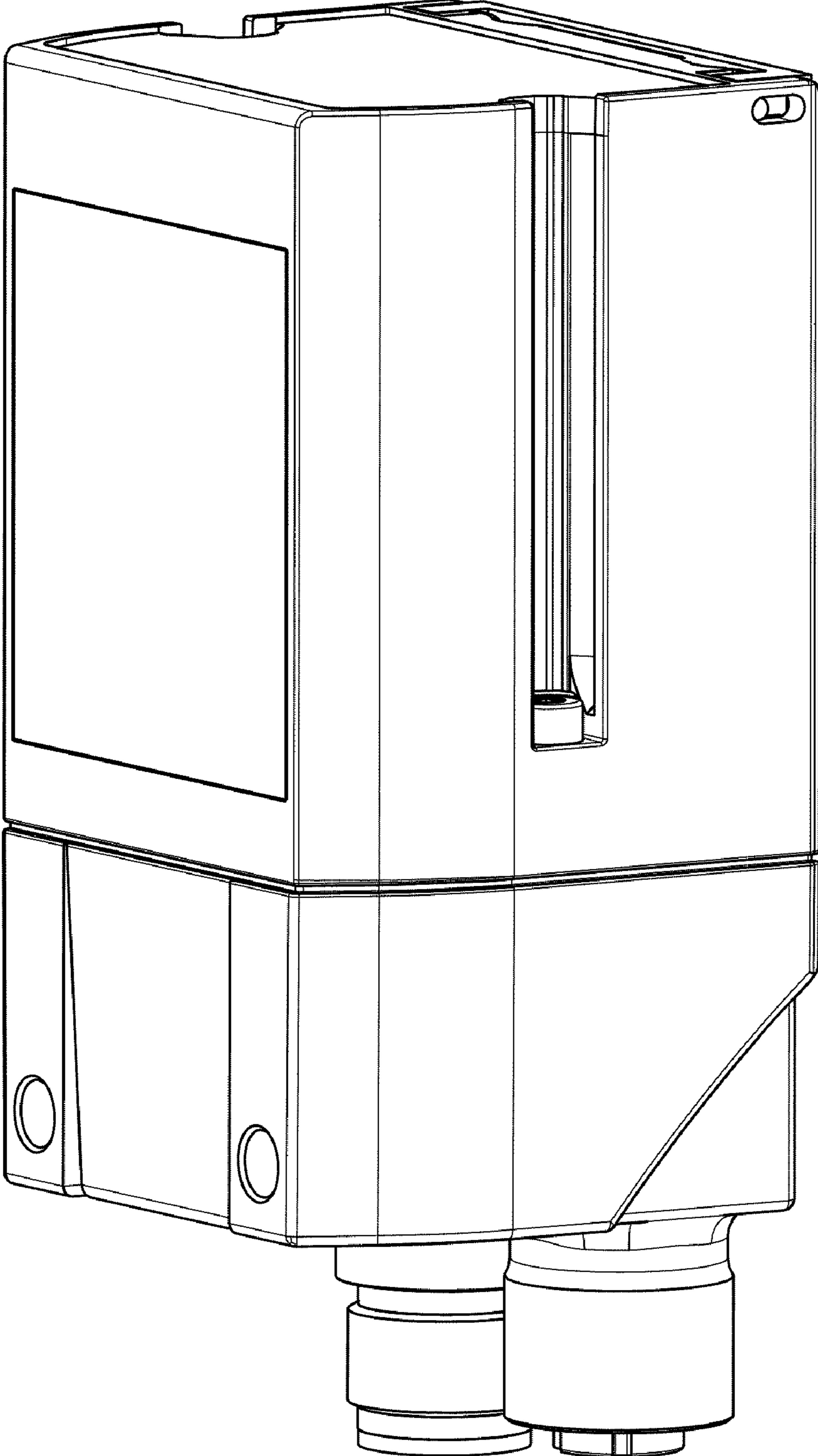

Fig. 15

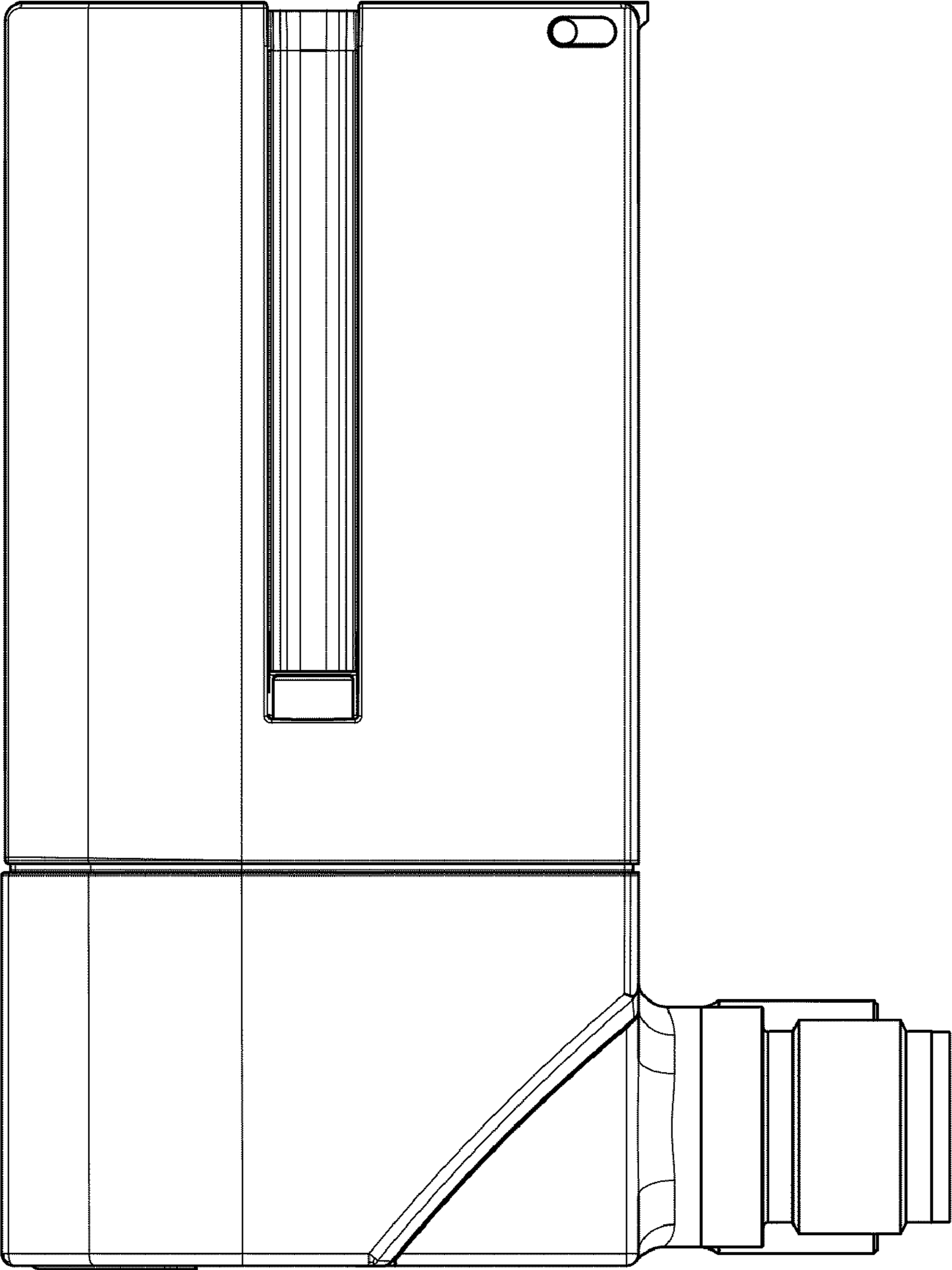

Fig. 16

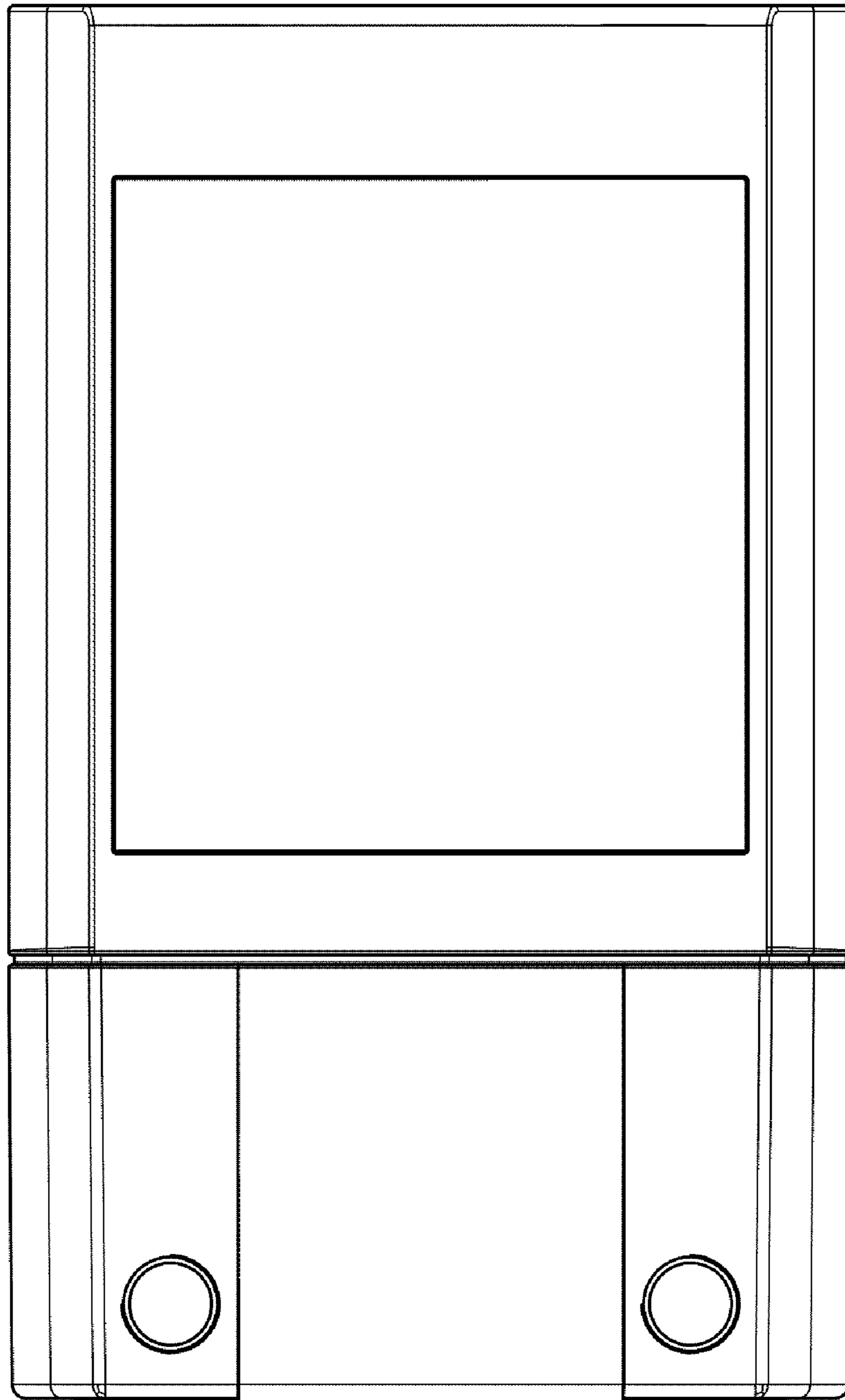

Fig. 17

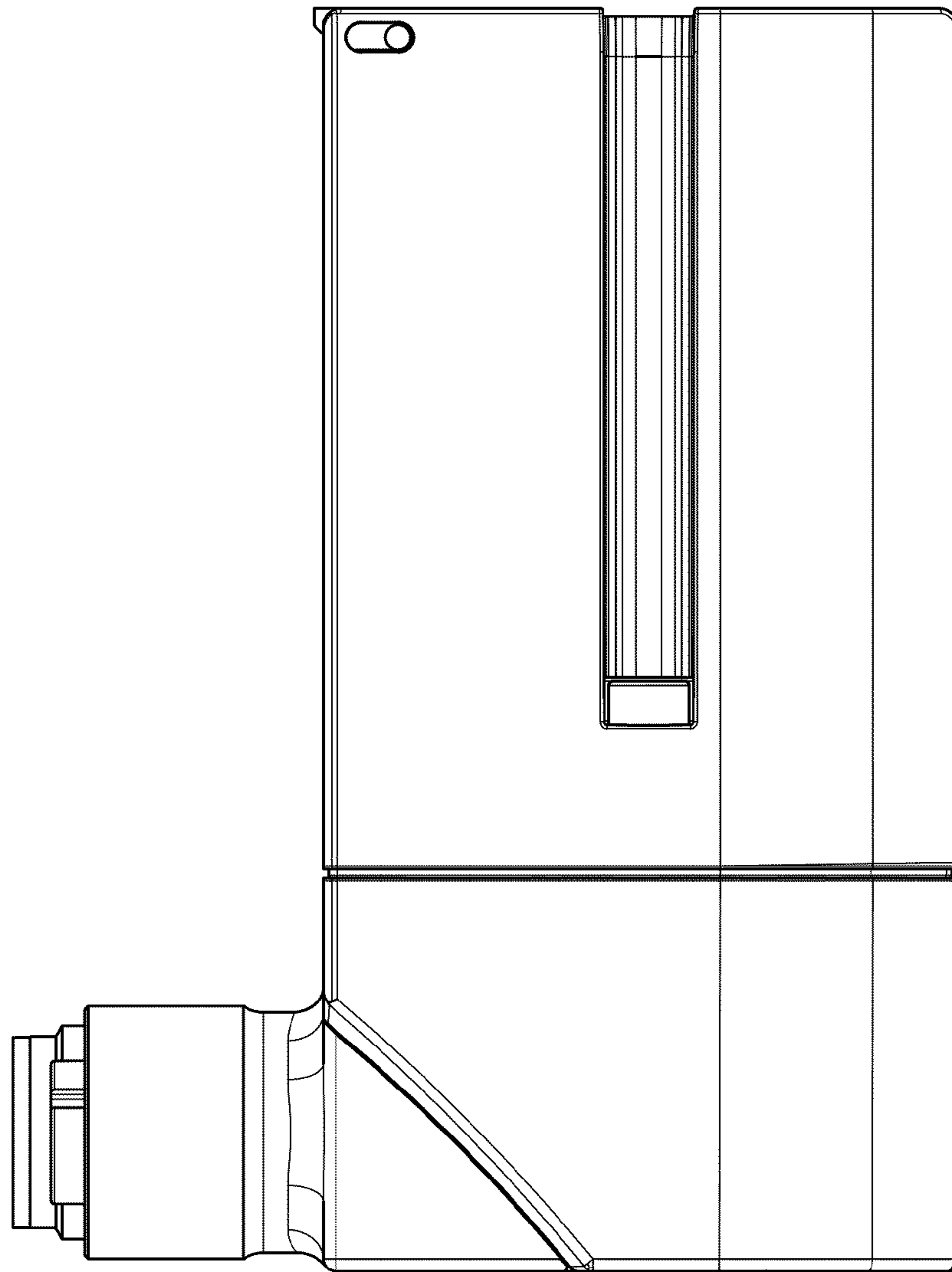

Fig. 18

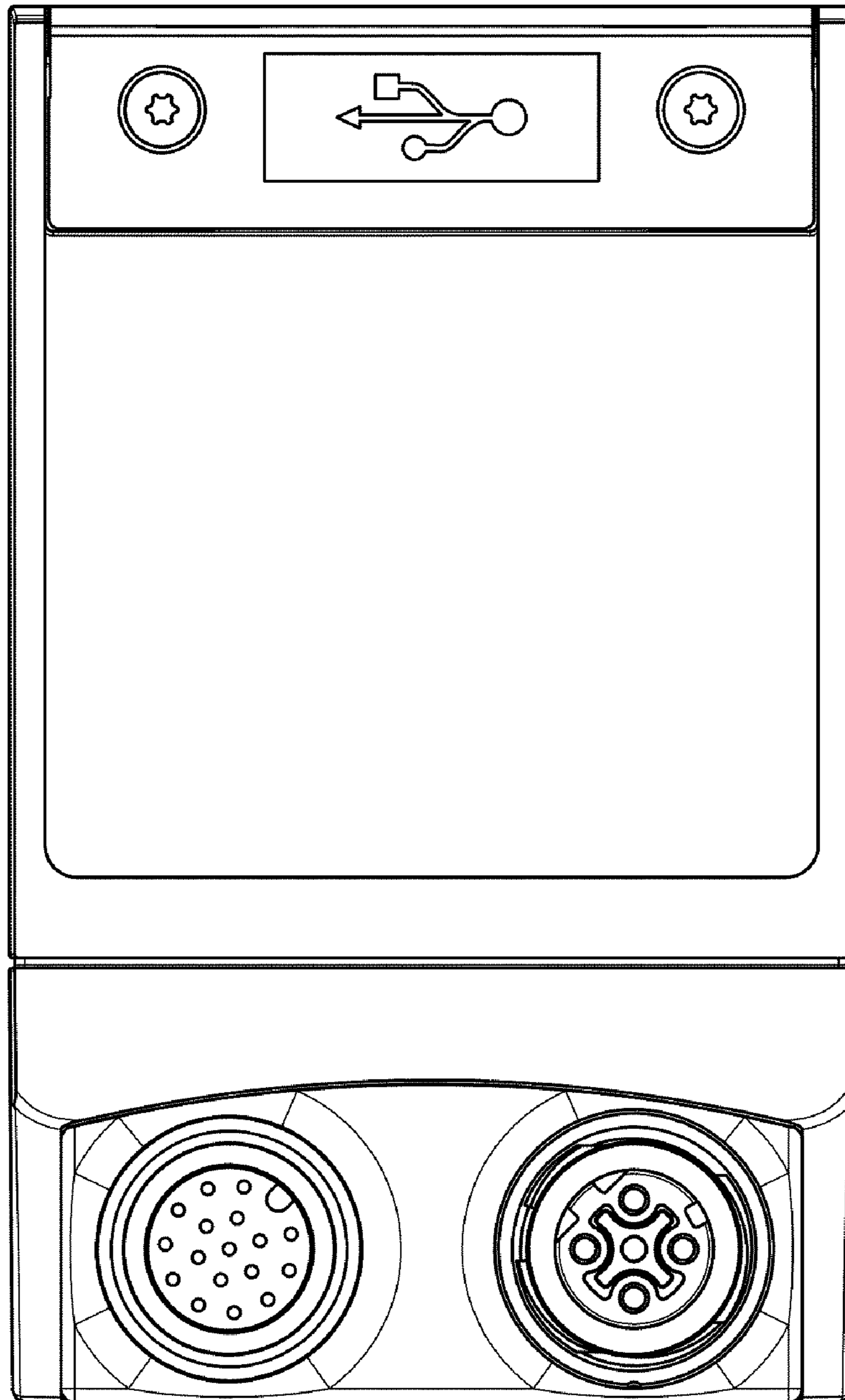

Fig. 19

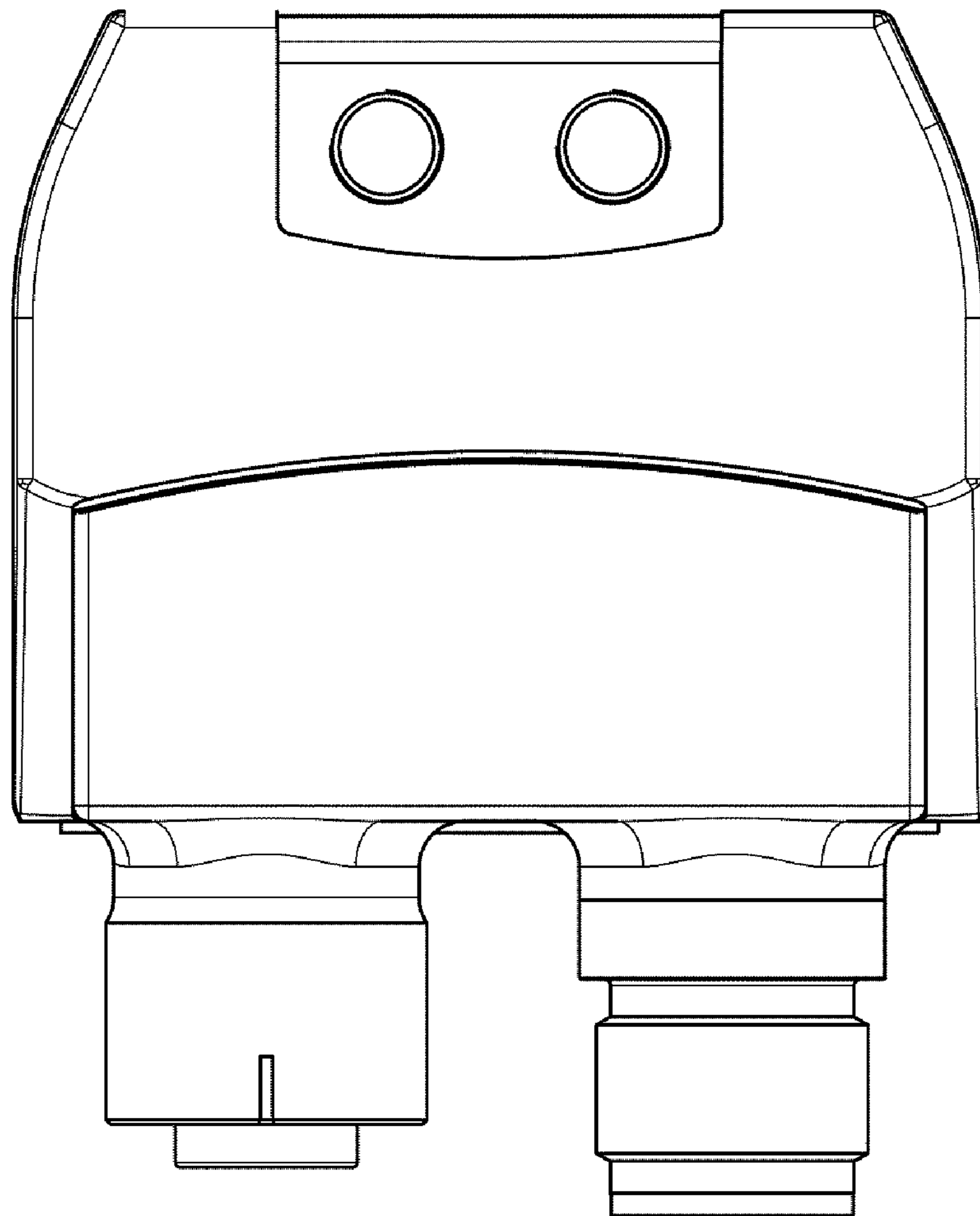

Fig. 20

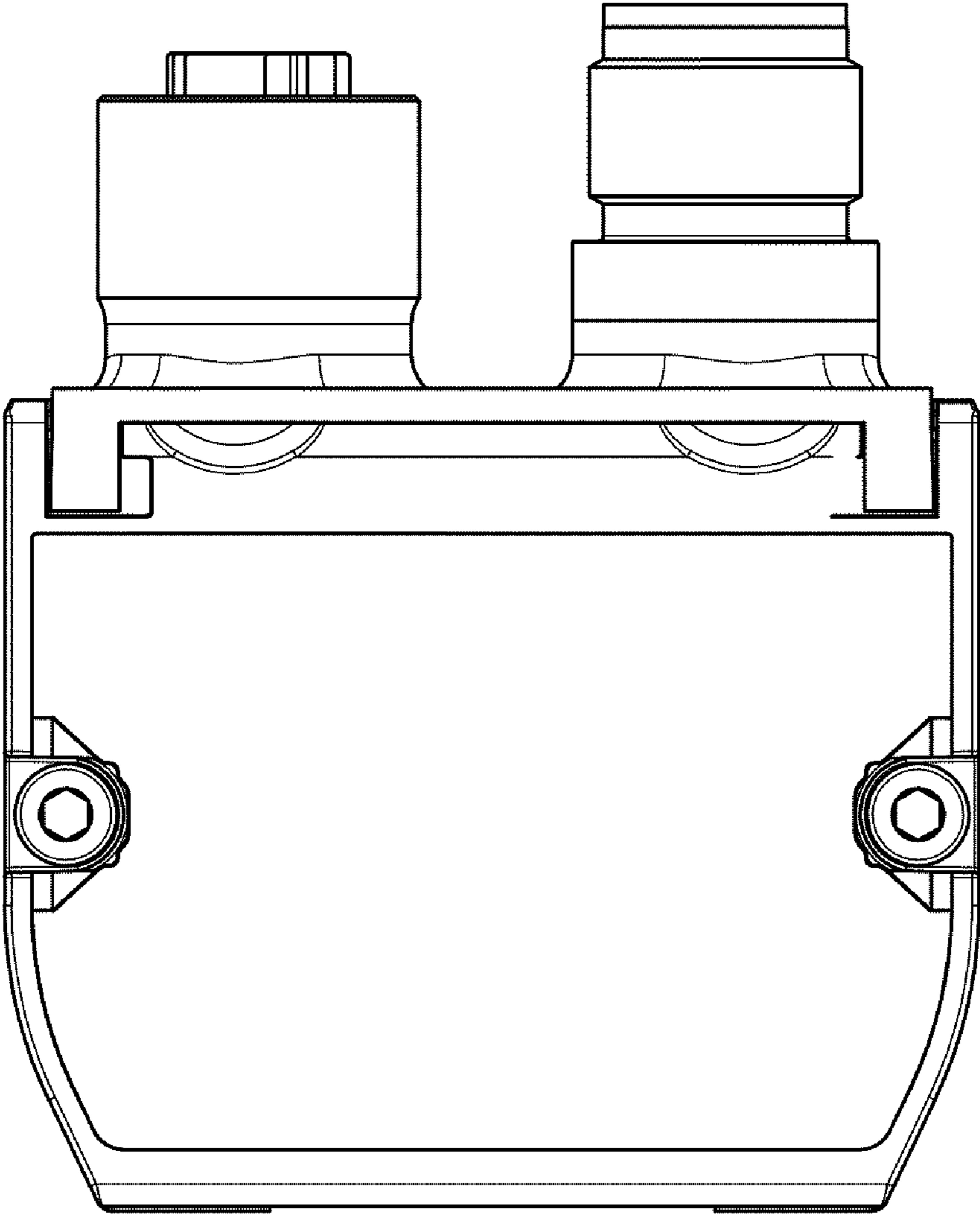

Fig. 21

