



US00D654189S

(12) **United States Design Patent**  
**Baccarini**

(10) **Patent No.:** **US D654,189 S**

(45) **Date of Patent:** **\*\* Feb. 14, 2012**

(54) **HEAD DETAIL**

(75) Inventor: **Tony Baccarini**, Essex (GB)

(73) Assignees: **Tony Baccarini (GB); Nigel Aulton (GB)**

(\*\*) Term: **14 Years**

(21) Appl. No.: **29/378,131**

(22) Filed: **Oct. 29, 2010**

1,875,576 A	9/1932	Een	
2,110,728 A	3/1938	Hoggatt	
2,129,497 A *	9/1938	Horn	52/474
2,234,043 A	3/1941	Dworetz	
2,261,054 A	10/1941	Dietrich	
2,301,187 A	11/1942	Balhatchet	
2,453,221 A	11/1948	Haden	

(Continued)

**FOREIGN PATENT DOCUMENTS**

DE 4300130 A1 7/1994

(Continued)

**OTHER PUBLICATIONS**

"Application No. PCT/GB2007/000492 International Search Report mailed Jun. 19, 2007", 5 pgs.

(Continued)

*Primary Examiner* — Doris Clark

(74) *Attorney, Agent, or Firm* — Schwegman, Lundberg & Woessner, P.A.

**Related U.S. Application Data**

(60) Division of application No. 29/359,398, filed on Apr. 9, 2010, now Pat. No. Des. 634,026, which is a division of application No. 29/335,688, filed on Apr. 20, 2009, now Pat. No. Des. 622,415, which is a division of application No. 29/276,951, filed on Feb. 9, 2007, now Pat. No. Des. 597,683, which is a continuation-in-part of application No. 11/519,371, filed on Sep. 11, 2006.

**Foreign Application Priority Data**

(30)	Apr. 10, 2006	(GB)	0607223.5
	Sep. 27, 2006	(GB)	0619068.0

(51) **LOC (9) Cl.** ..... **25-01**

(52) **U.S. Cl.** ..... **D25/136**

(58) **Field of Classification Search** ..... D25/119, D25/136; 52/262, 271, 287.1, 263, 286, 52/264, 283, 289, 290, 284, 320, 386, 387, 52/396.1, 764, 781.3, 541, 560, 567, 574, 52/591, 610, 483.1, 461, 465

See application file for complete search history.

(57) **CLAIM**

The ornamental design for a head detail, as shown and described.

**DESCRIPTION**

FIG. 1 is a rear elevation view of a head detail; FIG. 2 is a top plan view thereof; FIG. 3 is a front elevation view thereof; FIG. 4 is a right side elevation view thereof; FIG. 5 is a left side elevation view thereof; and, FIG. 6 is a perspective view thereof.

The ornamental design of a head detail pertains to elongated plaster moldings designed to run between a ceiling and a floor and having an abutment surface for abutment against the end surface of a partition wall or as a join between two such walls.

(56) **References Cited**

**U.S. PATENT DOCUMENTS**

1,465,539 A	8/1923	Atterbury
1,555,555 A	9/1925	Comerma

**1 Claim, 2 Drawing Sheets**

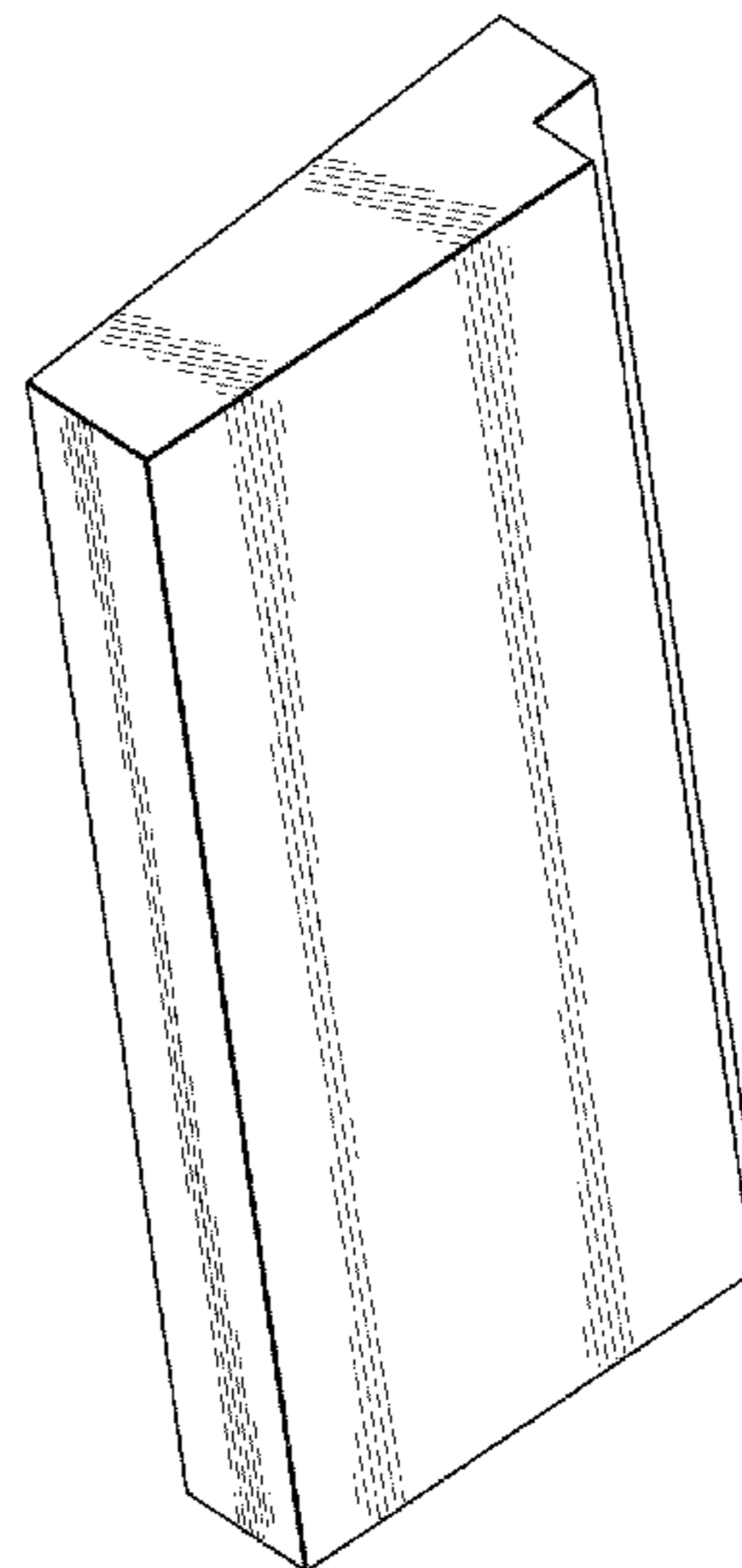

# US D654,189 S

Page 2

## U.S. PATENT DOCUMENTS

2,537,715	A	1/1951	Stead	
3,391,509	A	7/1968	Fruman	
3,396,504	A	8/1968	Luiz	
3,420,016	A	1/1969	Findlay	
3,465,488	A	9/1969	Peter	
3,654,734	A	4/1972	Lehman	
3,935,049	A	1/1976	Schmidt et al.	
3,973,371	A	8/1976	Heller	
D245,018	S	7/1977	Harris	
D251,804	S	5/1979	Balkany et al.	
4,753,622	A	6/1988	Nakama	
4,837,993	A *	6/1989	Studenski	52/208
4,964,250	A	10/1990	Nelson	
5,115,605	A	5/1992	Butler	
5,475,960	A *	12/1995	Lindal	52/478
5,501,050	A *	3/1996	Ruel	52/513
D372,546	S *	8/1996	Pelosi et al.	D25/164
5,544,463	A	8/1996	Bergin	
5,755,066	A	5/1998	Becker	
5,819,458	A	10/1998	Hadden	
5,934,030	A	8/1999	McDonald	
6,026,620	A	2/2000	Spude	
6,119,432	A	9/2000	Niemann	
6,176,053	B1	1/2001	St. Germain	
6,228,507	B1	5/2001	Hahn	
6,286,286	B1	9/2001	Simonar	
6,408,576	B1	6/2002	Roth	
D467,007	S	12/2002	Daudet et al.	
6,560,944	B1	5/2003	Wilson	
6,604,331	B1	8/2003	Pallas et al.	
6,990,778	B2 *	1/2006	Passeno	52/385
7,404,272	B2	7/2008	Piché	
D581,545	S	11/2008	Dove	
D597,683	S	8/2009	Baccarini	
D622,415	S	8/2010	Baccarini	
D629,125	S *	12/2010	Johnston	D25/136
D634,026	S	3/2011	Baccarini	
2003/0089058	A1	5/2003	Kunz et al.	

2004/0055245	A1	3/2004	Fitch
2004/0168384	A1	9/2004	Wesolowska
2005/0011159	A1	1/2005	Standal et al.
2007/0245654	A1	10/2007	Baccarini
2009/0038250	A1	2/2009	Frenkil

## FOREIGN PATENT DOCUMENTS

DE	29809789	9/1998
DE	20104657 U1	7/2001
DE	10041362	3/2002
DE	10102882	7/2002
FR	2793269	4/2003
GB	830602	3/1960
GB	2209135	5/1989
GB	2437083	10/2007
WO	WO-0233187	4/2002
WO	WO-0243953 A1	6/2002
WO	WO-03001007	1/2003
WO	WO-03076732 A1	9/2003
WO	WO-2007116198 A1	10/2007

## OTHER PUBLICATIONS

“Application No. PCT/GB2007/000492 Written Opinion mailed Jun. 19, 2007”, 6 pgs.

“U.S. Appl. No. 11/519,371, Non-Final Office Action mailed Jul. 2, 2010”, 13 Pgs.

“U.S. Appl. No. 12/335,688 Response filed Oct. 9, 2009 to Restriction Requirement mailed Sep. 18, 2009”, 3 pgs.

“U.S. Appl. No. 12/335,688, Restriction Requirement mailed Sep. 18, 2009”, 5 pgs.

“U.S. Appl. No. 11/519,371, Response filed Oct. 20, 2009 to Restriction Requirement mailed Aug. 20, 2009”, 11 pgs.

“U.S. Appl. No. 11/519,371 Restriction Requirement mailed Aug. 20, 2009”, 8 pgs.

“UK Search Report for Application No. 0619068.0”, (Oct. 24, 2006).

“UK Search Report for Application No. 0619068.0”, (May 26, 2006).

\* cited by examiner

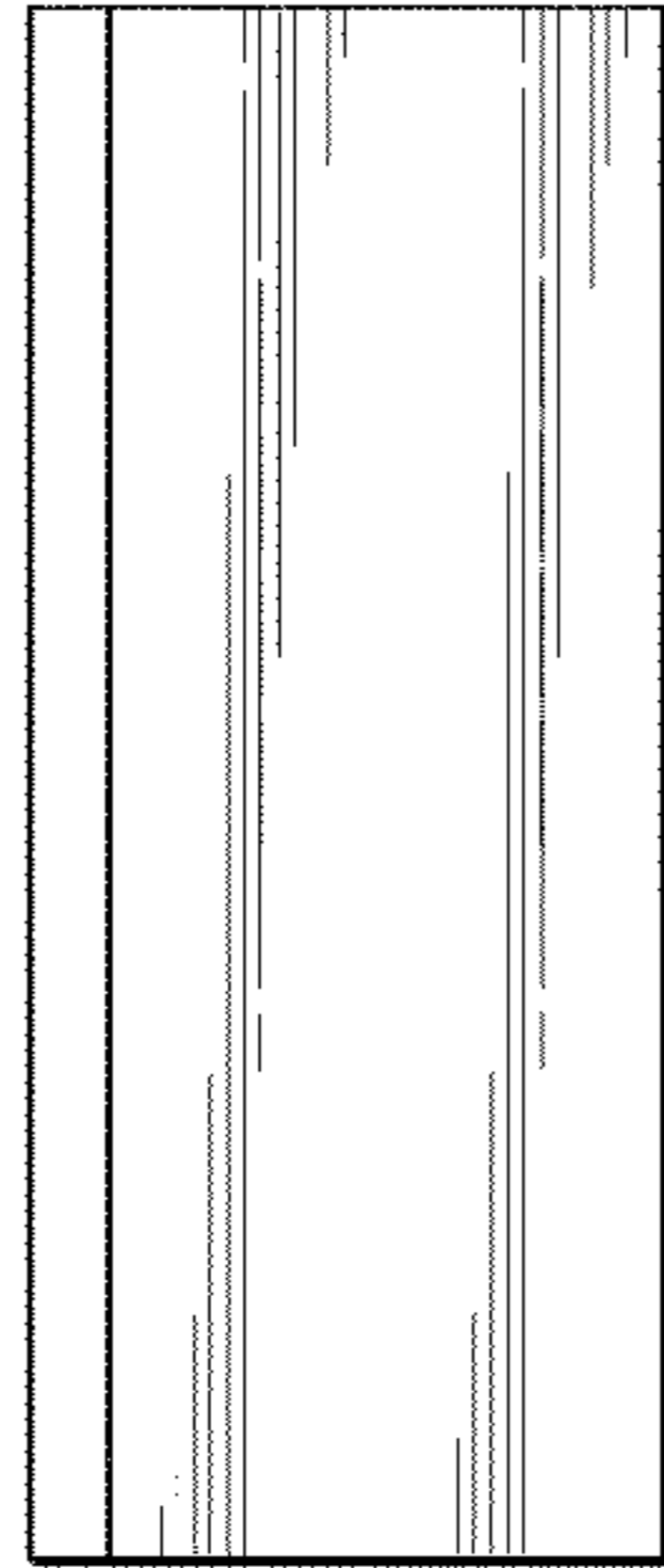

*FIG. 3*

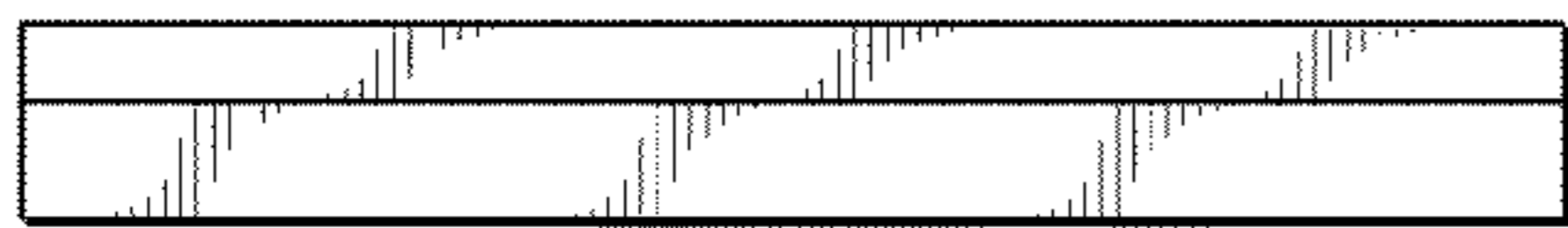

*FIG. 4*

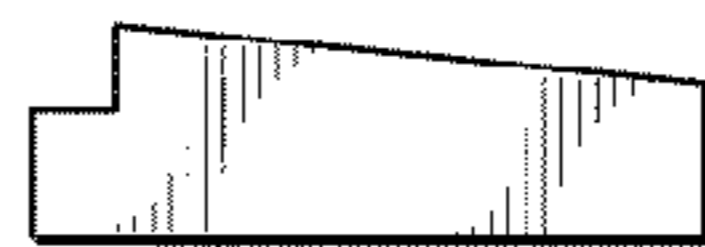

*FIG. 2*

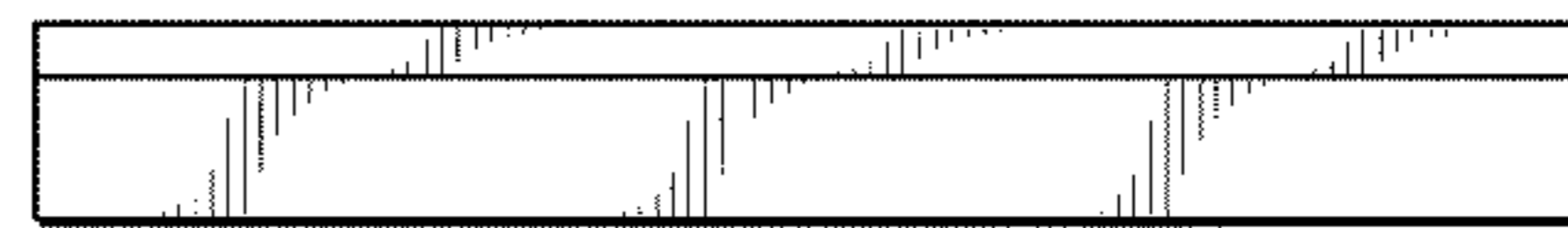

*FIG. 5*

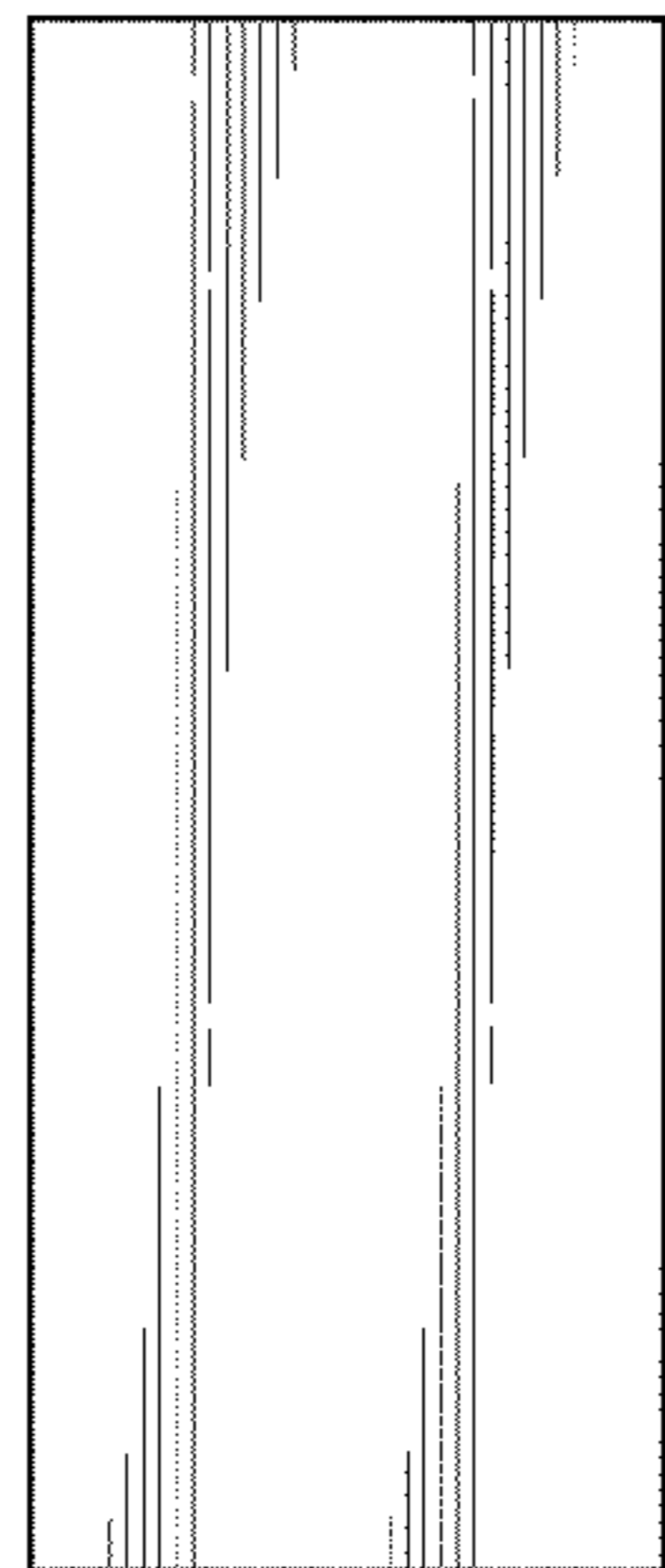

*FIG. 1*

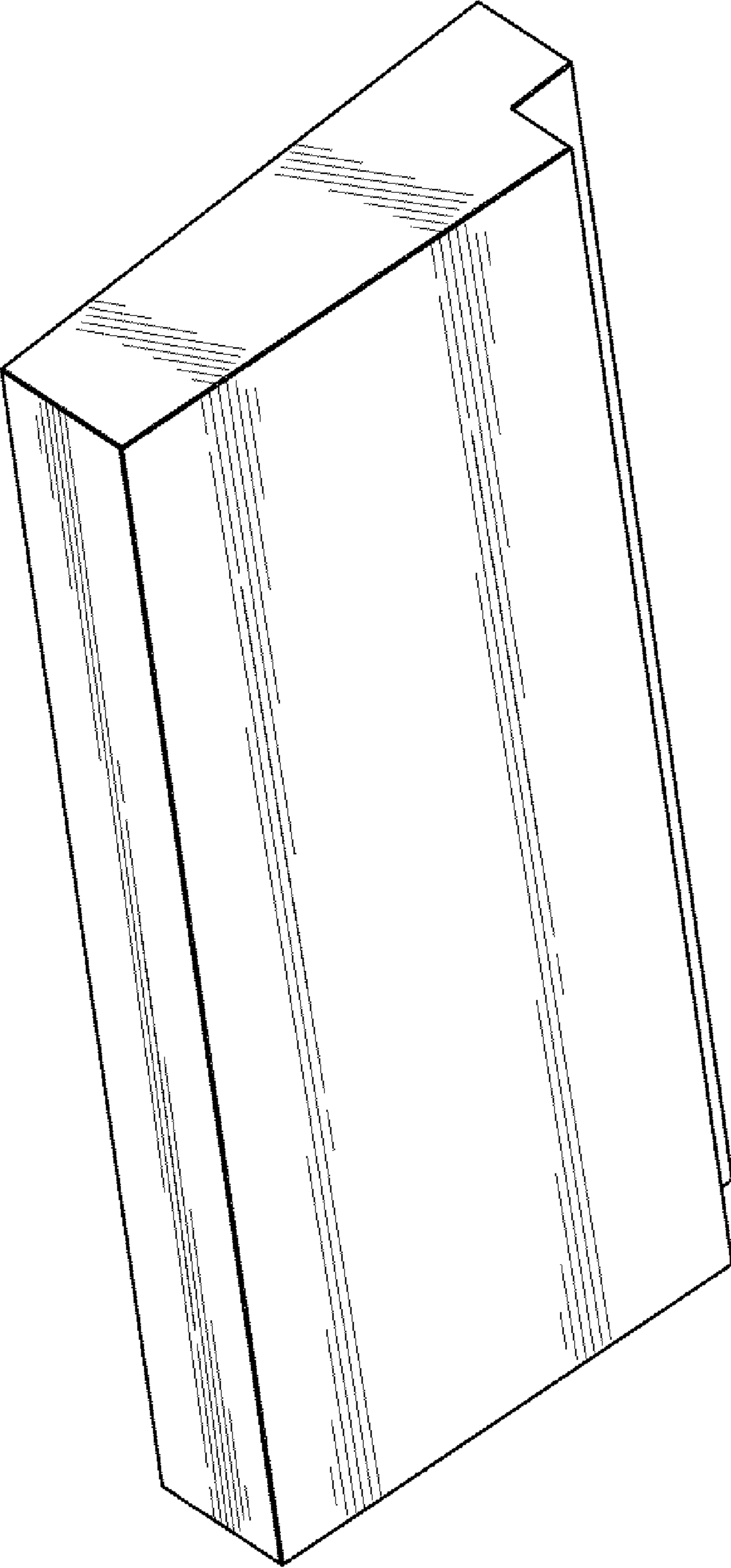

**FIG. 6**