



US00D654166S

(12) **United States Design Patent**  
**Lair**

(10) **Patent No.:** **US D654,166 S**

(45) **Date of Patent:** **\*\* Feb. 14, 2012**

(54) **ENTERAL CONNECTOR**

(75) **Inventor:** **Anthony C. Lair**, Alpharetta, GA (US)

(73) **Assignee:** **NeoMed, Inc.**, Woodstock, GA (US)

(\*\*) **Term:** **14 Years**

(21) **Appl. No.:** **29/367,357**

(22) **Filed:** **Aug. 6, 2010**

(51) **LOC (9) Cl.** ..... **24-02**

(52) **U.S. Cl.** ..... **D24/129**

(58) **Field of Classification Search** ..... D24/129–130,  
D24/108, 111, 112, 224, 121, 133; 604/411–416,  
604/403, 27, 37, 39, 48, 520  
See application file for complete search history.

Corpak MedSystems—Corflo Extension Sets; 3 pgs.  
Philips Children’s Medical Ventures—Extension Sets; 3 pgs.  
Codan—Light Safe Extension Sets; 2 pgs.; at least as early as Aug. 5,  
2009.

\* cited by examiner

*Primary Examiner* — T. Chase Nelson

*Assistant Examiner* — Eric Goodman

(74) *Attorney, Agent, or Firm* — Gardner Groff Greenwald  
& Villanueva, PC

(57) **CLAIM**

The ornamental design for an enteral connector, substantially  
as shown and described.

(56) **References Cited**

**U.S. PATENT DOCUMENTS**

3,731,684	A *	5/1973	Spiegel	604/326
D282,962	S *	3/1986	Gerber	D23/262
D307,795	S *	5/1990	Frantz	D24/111
4,994,048	A *	2/1991	Metzger	604/533
5,137,527	A *	8/1992	Miller et al.	604/415
5,549,550	A *	8/1996	Mazer et al.	604/83
5,746,715	A *	5/1998	Mazer et al.	604/83
5,755,689	A *	5/1998	Mazer et al.	604/84
6,029,946	A *	2/2000	Doyle	251/149.1
6,036,669	A *	3/2000	Cole et al.	604/83
6,277,092	B1 *	8/2001	Cole et al.	604/82
6,290,206	B1 *	9/2001	Doyle	251/149.1
6,962,563	B2 *	11/2005	Yasunaga	600/114
7,846,131	B2 *	12/2010	Hudson et al.	604/151
2001/0045539	A1 *	11/2001	Doyle	251/149.1
2007/0017527	A1 *	1/2007	Totz	128/207.15
2007/0060898	A1 *	3/2007	Shaughnessy et al.	604/284
2008/0135725	A1 *	6/2008	Bisch et al.	250/206
2008/0183153	A1 *	7/2008	Enns	604/533
2009/0264824	A1 *	10/2009	Bisch et al.	604/151

**OTHER PUBLICATIONS**

Ameritus Medical Products—Enteral Only Extension Sets; 8 pgs.

**DESCRIPTION**

FIG. 1 is a first perspective view of an enteral connector showing the new design.

FIG. 2 is a second perspective view of the enteral connector design of FIG. 1.

FIG. 3 is a first side view of the enteral connector design of FIG. 1.

FIG. 4 is a second side view of the enteral connector design of FIG. 1.

FIG. 5 is a top view of the enteral connector design of FIG. 1.

FIG. 6 is a bottom view of the enteral connector design of FIG. 1.

FIG. 7 is a first end view of the enteral connector design of FIG. 1; and,

FIG. 8 is a second end view of the enteral connector design of FIG. 1.

Portions shown in broken lines are for illustrative purposes only and form no part of the claimed design.

**1 Claim, 4 Drawing Sheets**

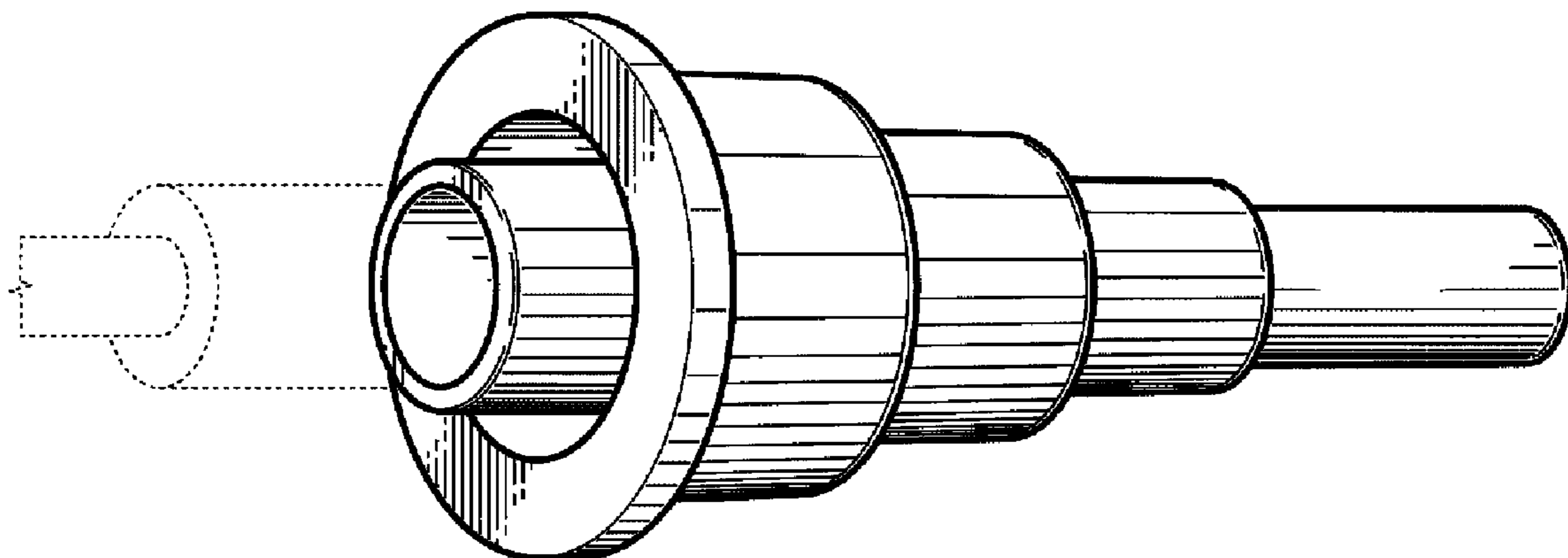

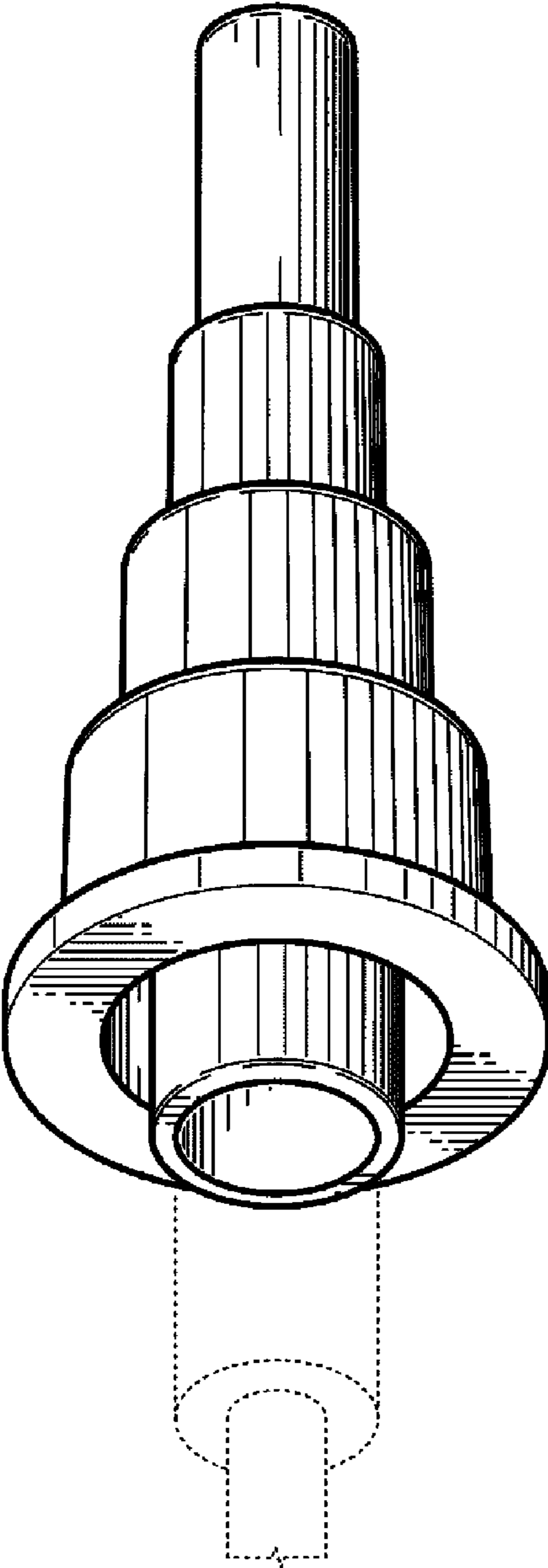

FIG. 1

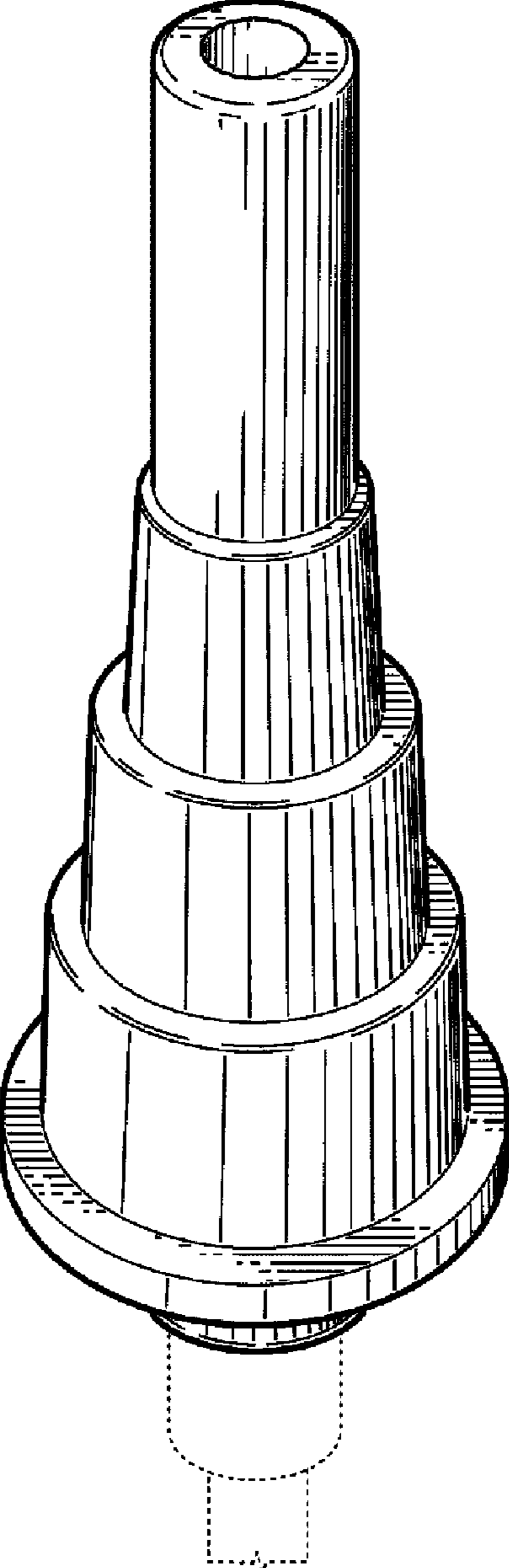

FIG. 2

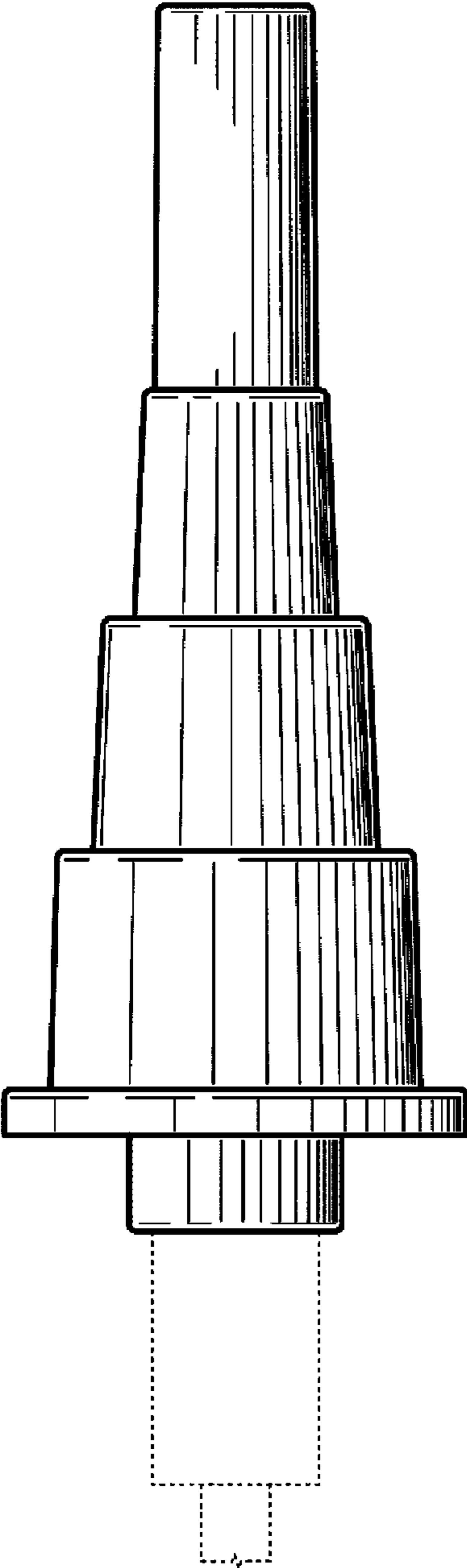

FIG. 3

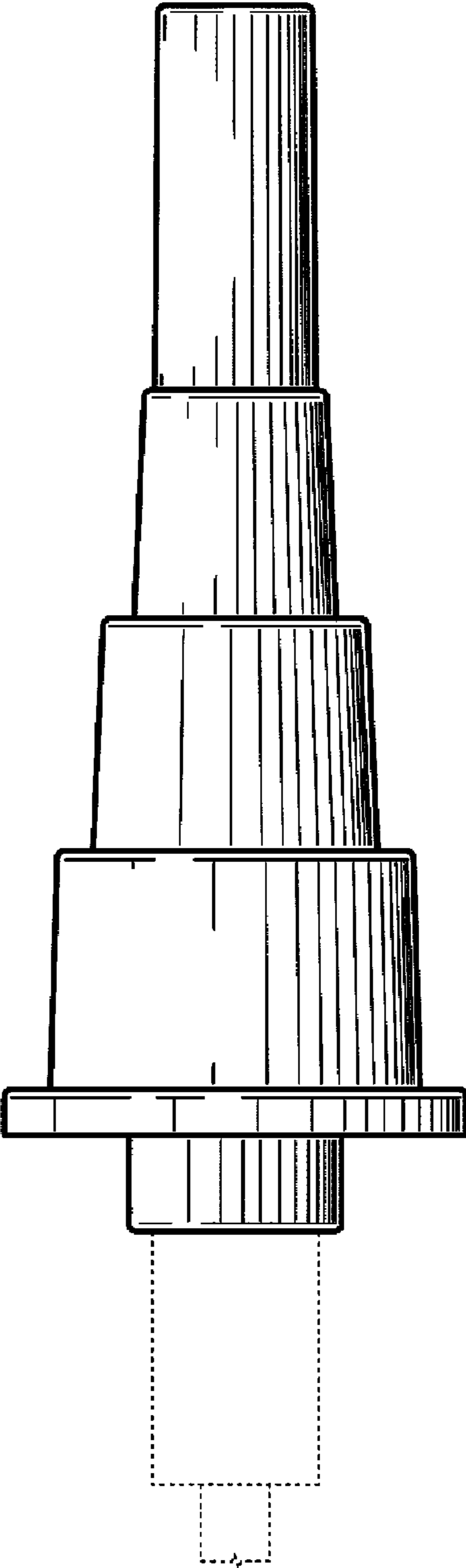

FIG. 4

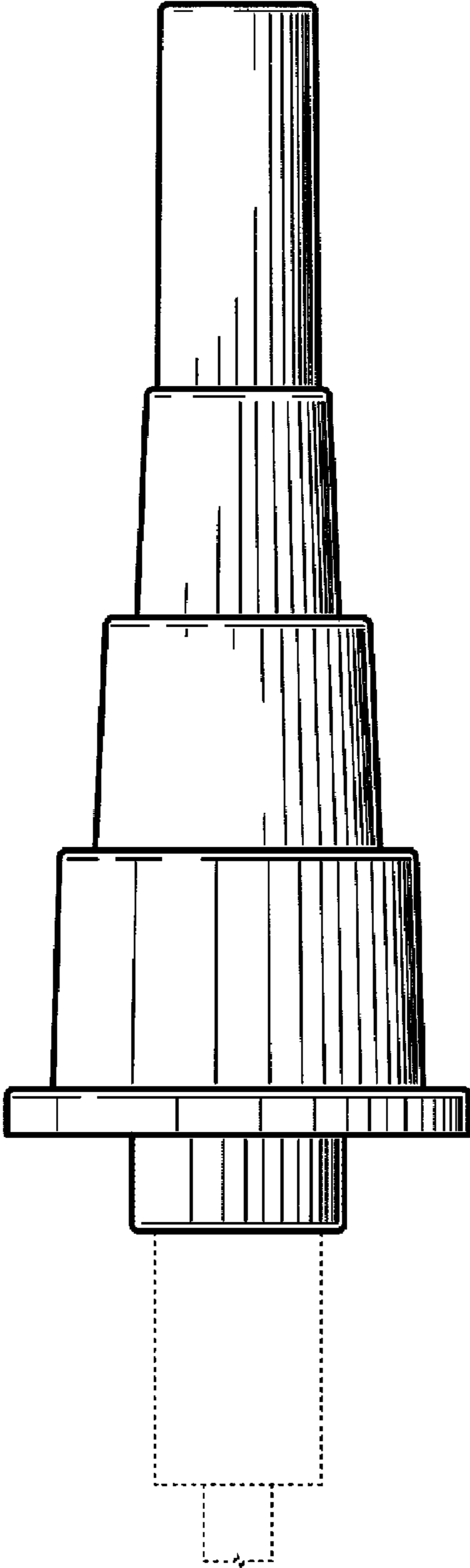

FIG. 5

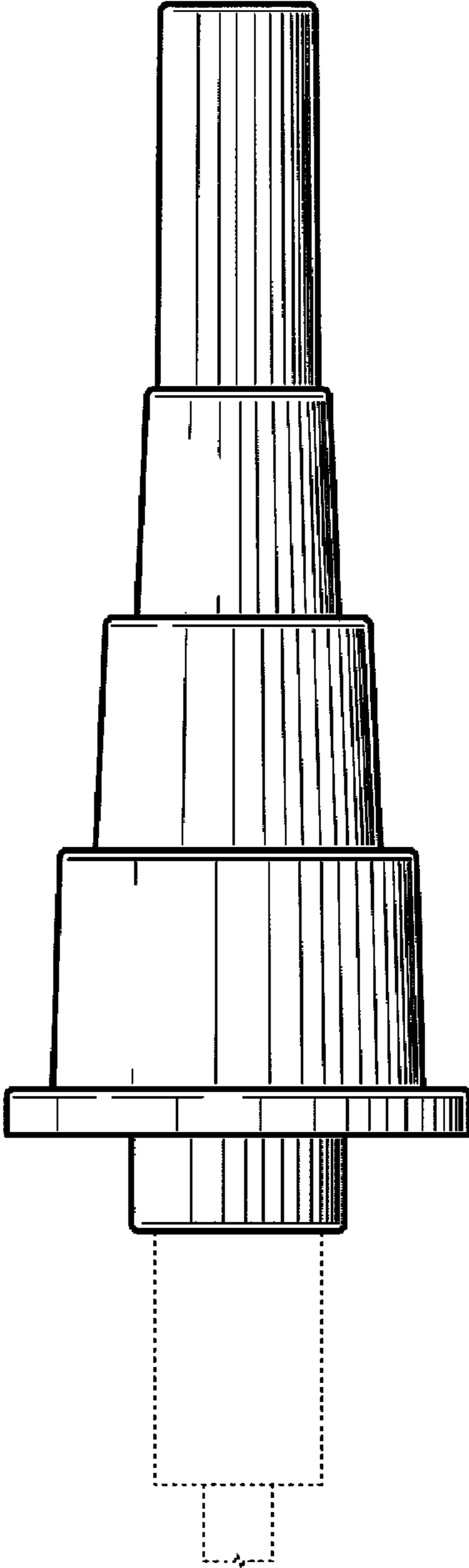
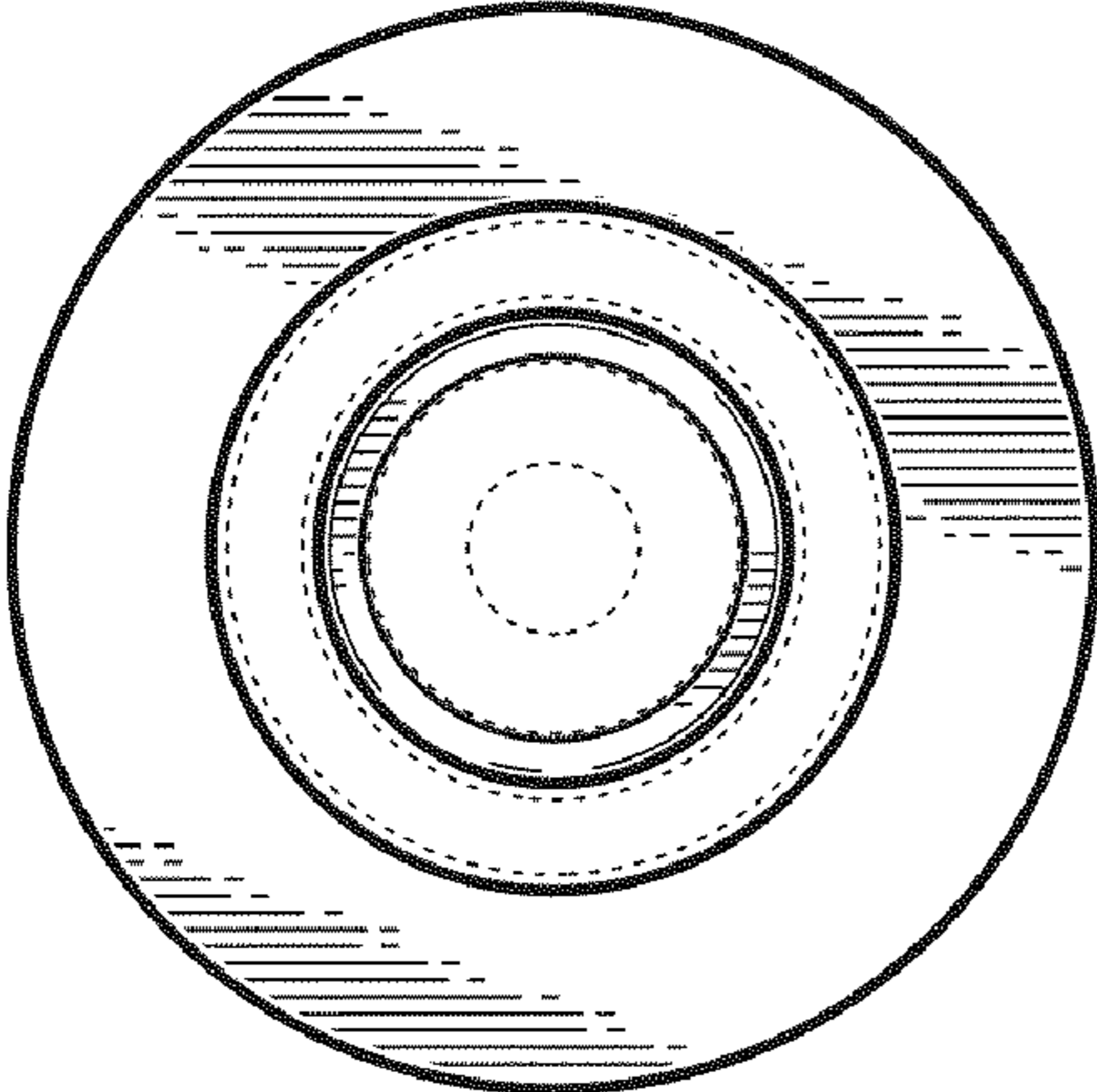
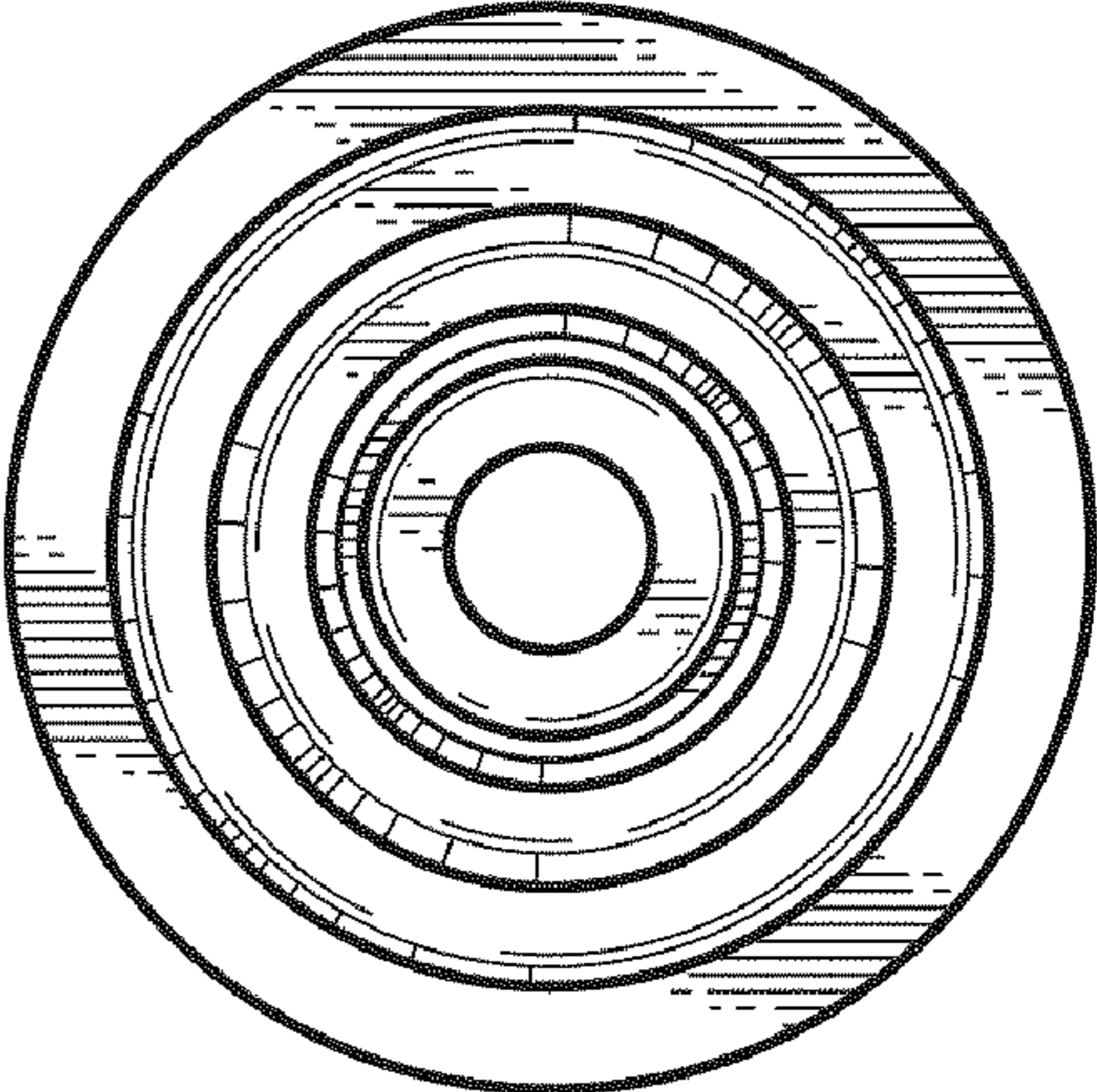

FIG. 6



**FIG. 7**



**FIG. 8**