



US00D654051S

(12) **United States Design Patent**
Duan et al.

(10) **Patent No.:** **US D654,051 S**
(45) **Date of Patent:** **** Feb. 14, 2012**

(54) **MOBILE PHONE**

(75) Inventors: **Chao Duan**, Shenzhen (CN); **Chia-Hua Chen**, Shindian (TW)

(73) Assignee: **FIH (Hong Kong) Limited**, Kowloon (HK)

(**) Term: **14 Years**

(21) Appl. No.: **29/402,835**

(22) Filed: **Sep. 28, 2011**

(51) **LOC (9) Cl.** **14-03**

(52) **U.S. Cl.** **D14/138 AD**

(58) **Field of Classification Search** D14/138 AD,
D14/138 G, 138 R, 138 AC, 496, 341, 345,
D14/346, 203.7, 203.4, 203.3, 203.1, 248,
D14/218, 138 AB, 191; 455/575.1, 556.2,
455/556.1, 575.4, 566, 575.3; D10/65; 379/433.01,
379/433.04, 433.11, 433.12, 433.13; D21/329-331,
D21/517

See application file for complete search history.

(56) **References Cited**

U.S. PATENT DOCUMENTS

7,283,847	B2 *	10/2007	Kim	455/566
D567,819	S *	4/2008	Devericks et al.	D14/496
D583,810	S *	12/2008	Chen	D14/345
D597,092	S *	7/2009	Wang et al.	D14/346
D615,059	S *	5/2010	Price et al.	D14/138 G
D619,989	S *	7/2010	Huang	D14/138 G

(Continued)

OTHER PUBLICATIONS

Samsung Galaxy S WiFi 5.0 telephone, announced Feb. 2011, [online], [site visited Dec. 16, 2011]. Available from Internet, <URL: <http://www.gsmarena.com>>.*

Samsung I9100 Galaxy S II telephone, announced Feb. 2011, [online], [site visited Dec. 16, 2011]. Available from Internet, <URL: <http://www.gsmarena.com>>.*

(Continued)

Primary Examiner — Jeffrey D Asch

(74) *Attorney, Agent, or Firm* — Altis Law Group, Inc.

(57) **CLAIM**

The ornamental design for a mobile phone, as shown and described.

DESCRIPTION

FIG. 1 is a perspective view of a mobile phone showing our new design and in a first configuration;

FIG. 2 is a front elevational view of the new design and in the first configuration;

FIG. 3 is a rear elevational view of the new design and in the first configuration;

FIG. 4 is a right side elevational view of the new design and in the first configuration;

FIG. 5 is a left side elevational view of the new design and in the first configuration;

FIG. 6 is a top plan view of the new design and in the first configuration;

FIG. 7 is a bottom plan view of the new design and in the first configuration;

FIG. 8 is a perspective view of the mobile phone of FIG. 1 in a second configuration;

FIG. 9 is a front elevational view of the new design and in the second configuration;

FIG. 10 is a rear elevational view of the new design and in the second configuration;

FIG. 11 is a right side elevational view of the new design and in the second configuration;

FIG. 12 is a left side elevational view of the new design and in the second configuration;

FIG. 13 is a top plan view of the new design and in the second configuration; and,

FIG. 14 is a bottom plan view of the new design and in the second configuration.

The broken lines shown throughout the views, which are immediately adjacent to the shaded areas and define unshaded regions, represent the bounds of the claimed design, while all other broken lines are directed to environment and are for illustrative purposes only; the broken lines form no part of the claimed design.

1 Claim, 14 Drawing Sheets

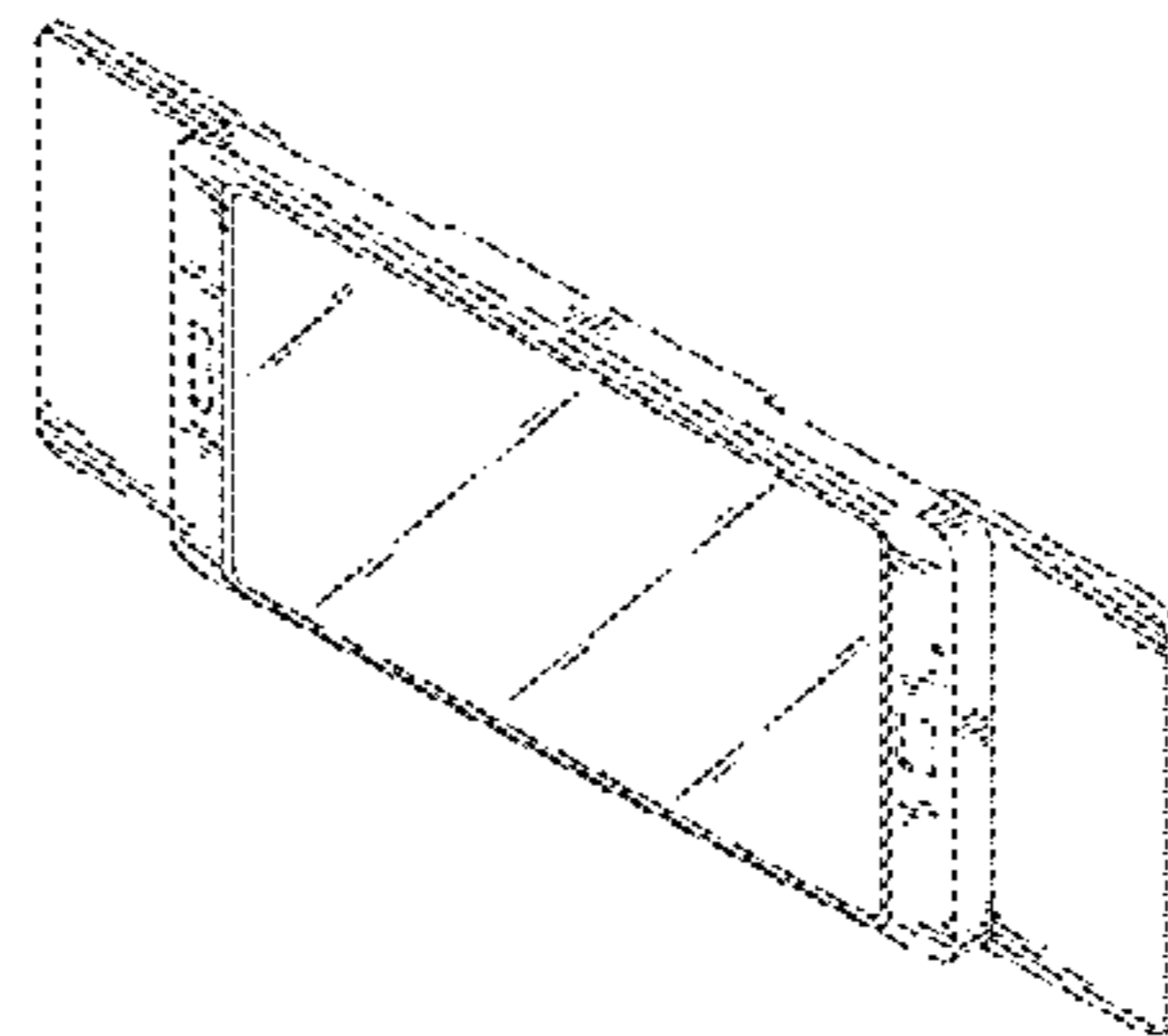
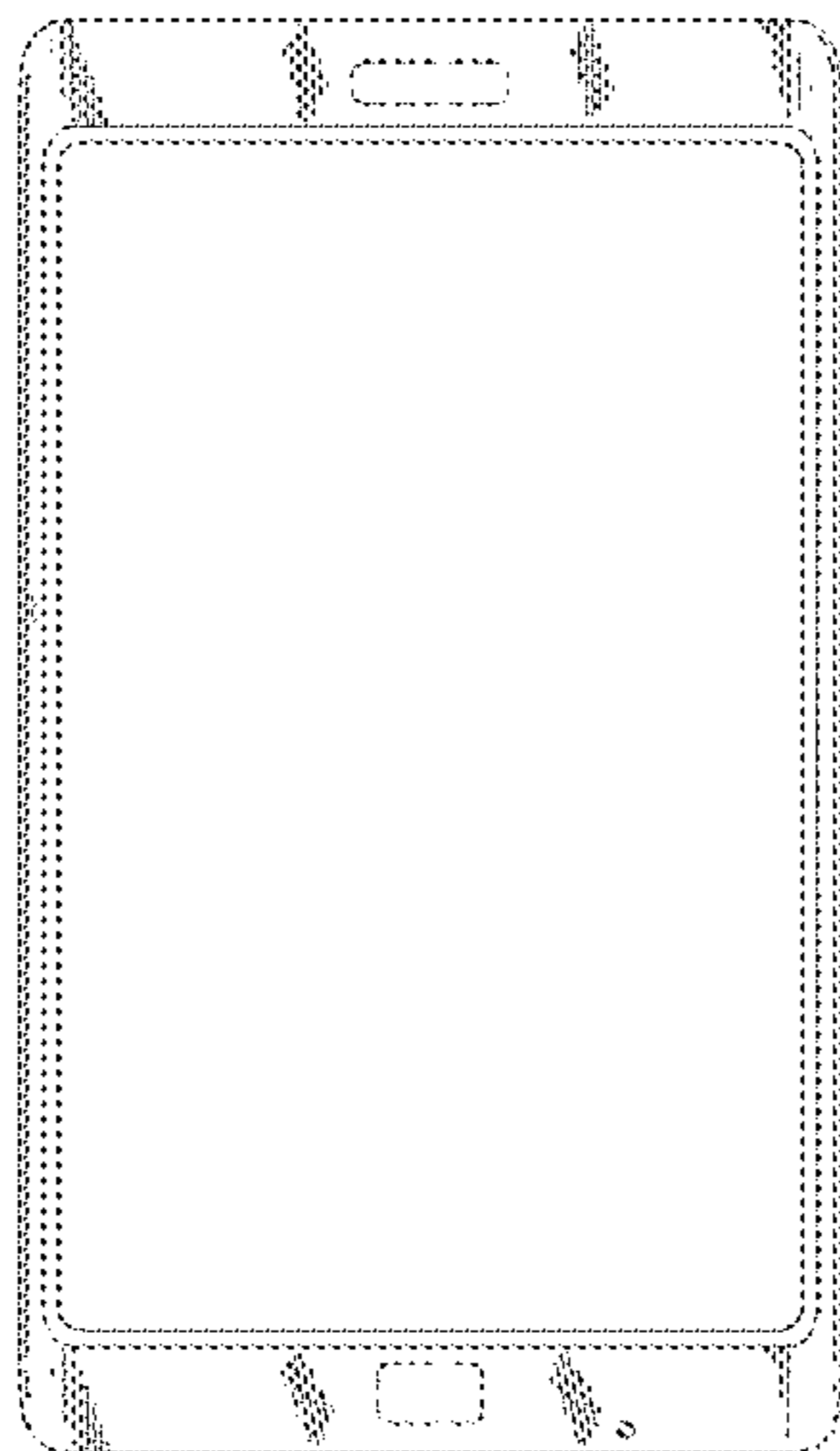

US D654,051 S

Page 2

U.S. PATENT DOCUMENTS

D619,990 S * 7/2010 Lai D14/138 G
7,831,286 B2 * 11/2010 Cho et al. 455/575.4
D630,607 S * 1/2011 Li D14/138 AB
7,872,861 B2 * 1/2011 Ou et al. 361/679.27
7,880,724 B2 * 2/2011 Nguyen et al. 345/168
7,884,803 B2 * 2/2011 Huang 345/169
D633,888 S * 3/2011 Eguchi D14/138 AD
D641,724 S * 7/2011 Roka D14/138 AD
D645,437 S * 9/2011 Tzeng D14/138 AD
D646,255 S * 10/2011 Kim D14/138 G
D646,661 S * 10/2011 Kim D14/138 AD
8,032,193 B2 * 10/2011 Xin et al. 455/575.4
D650,351 S * 12/2011 Tsai et al. D14/138 G
D650,352 S * 12/2011 Cho D14/138 G
2006/0056141 A1 * 3/2006 Pihlaja et al. 361/683
2007/0037618 A1 * 2/2007 Lee 455/575.4
2009/0170566 A1 * 7/2009 Kwon et al. 455/566
2010/0079938 A1 * 4/2010 Paschke et al. 361/679.14
2011/0021251 A1 * 1/2011 Linden 455/566
2011/0117971 A1 * 5/2011 Kim et al. 455/566
2011/0143815 A1 * 6/2011 Inami 455/566
2011/0171934 A1 * 7/2011 Lim et al. 455/412.1
2011/0294555 A1 * 12/2011 Happonen et al. 455/575.4

OTHER PUBLICATIONS

Samsung Galaxy Note telephone, announced Sep. 2010, [online], [site visited Dec. 16, 2011]. Available from Internet, <URL: <http://www.gsmarena.com>>.*
Samsung 1997 Infuse 4G telephone, announced Jan. 2011, [online], [site visited Dec. 16, 2011]. Available from Internet, <URL: <http://www.gsmarena.com>>.*
Samsung I8700 Omnia 7 telephone, announced Oct. 2010, [online], [site visited Dec. 16, 2011]. Available from Internet, <URL: <http://www.gsmarena.com>>.*
LG Optimus Big LU6800 telephone, announced Apr. 2011, [online], [site visited Dec. 16, 2011]. Available from Internet, <URL: <http://www.gsmarena.com>>.*
LG Optimus LTE LU6200 telephone, announced Oct. 2011, [online], [site visited Dec. 16, 2011]. Available from Internet, <URL: <http://www.gsmarena.com>>.*
Samsung Galaxy W I8350 telephone, announced Sep. 2011, [online], [site visited Dec. 16, 2011]. Available from Internet, <URL: <http://www.gsmarena.com>>.*

* cited by examiner

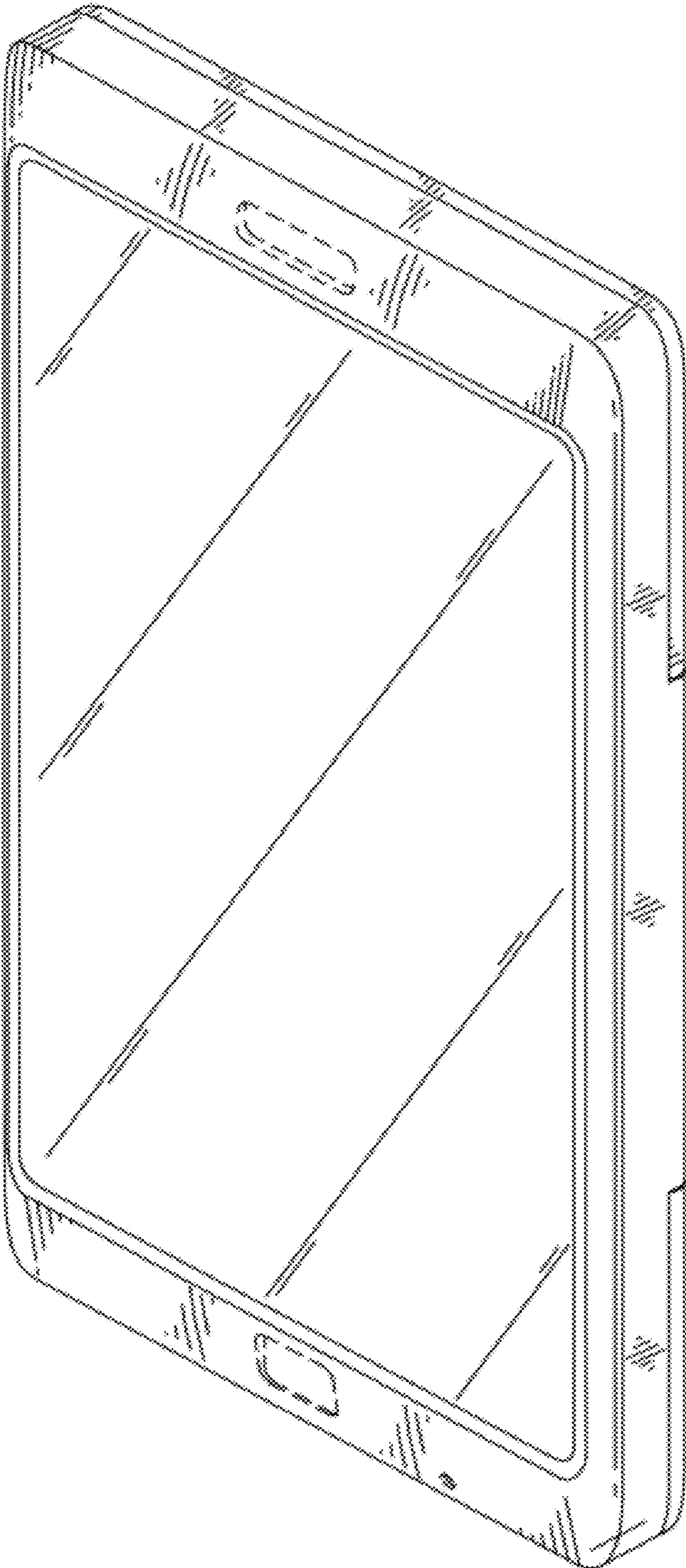

FIG. 1

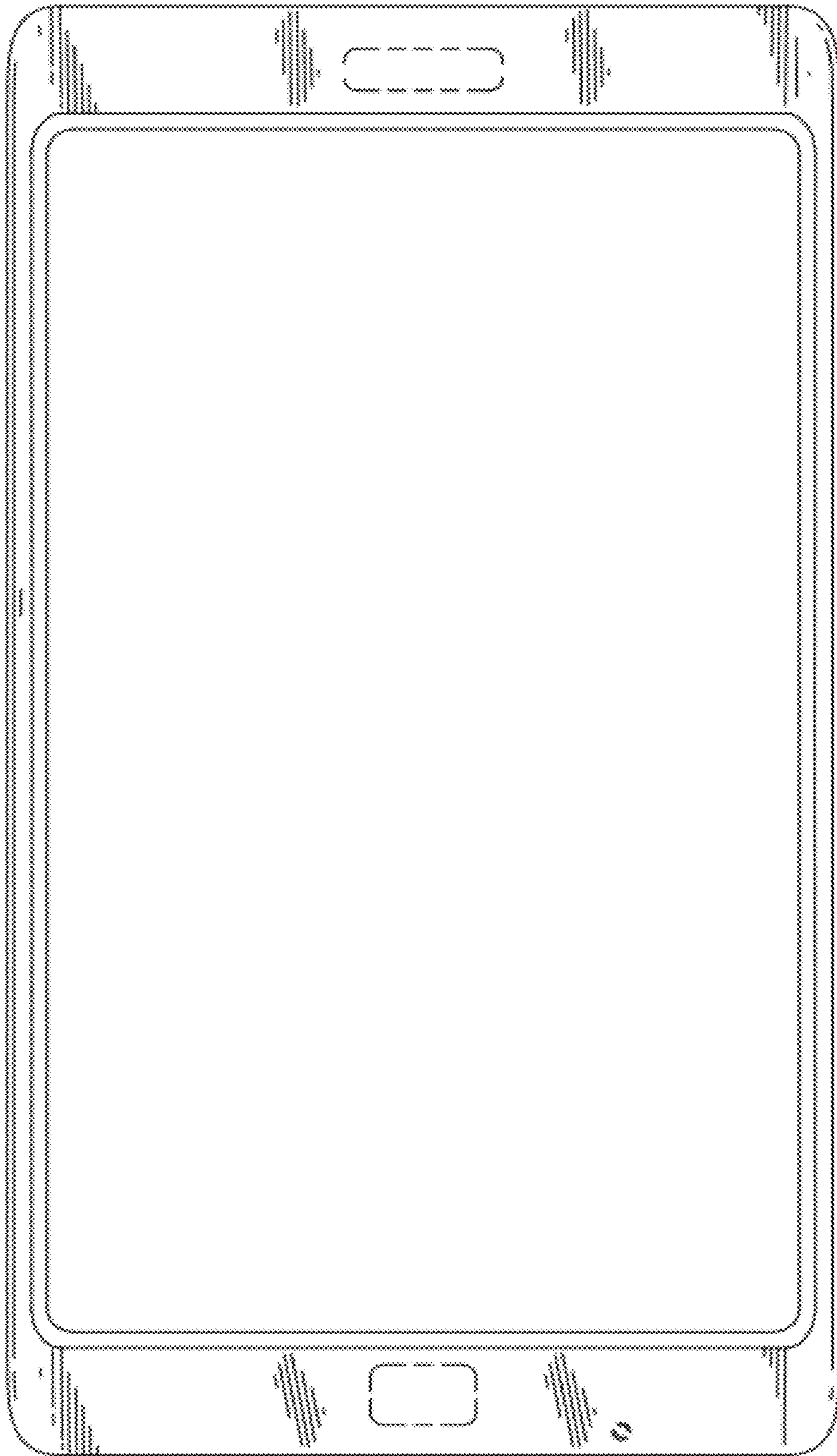

FIG. 2

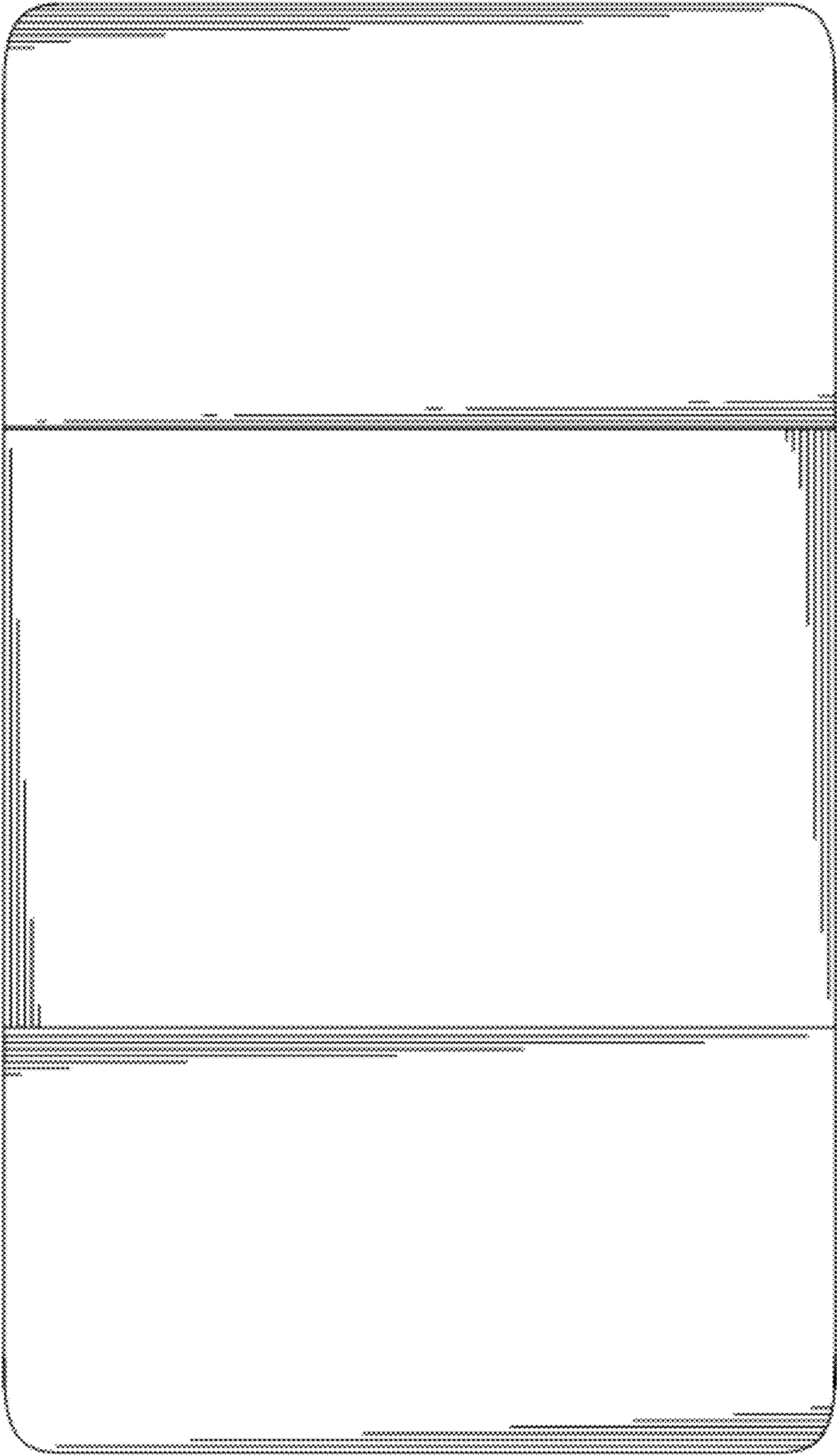

FIG. 3

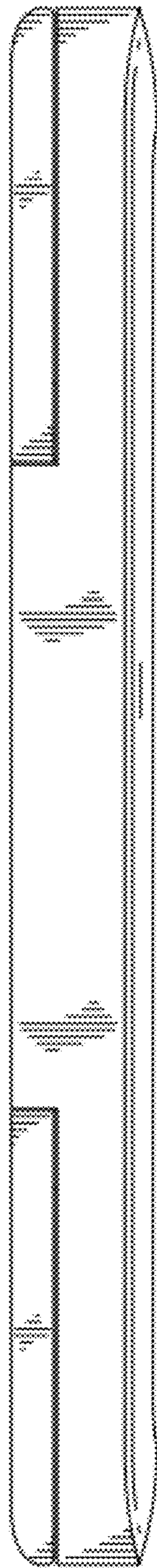

FIG. 4

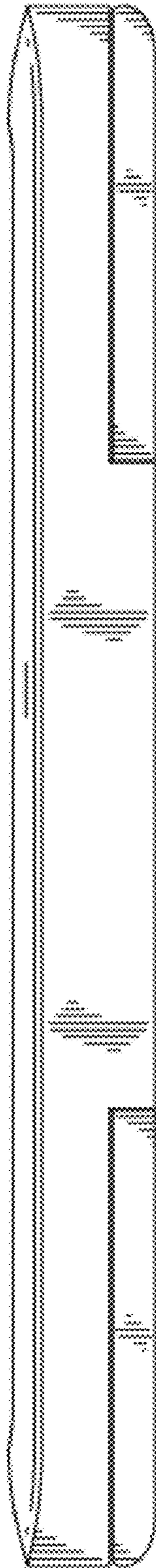

FIG. 5



FIG. 6

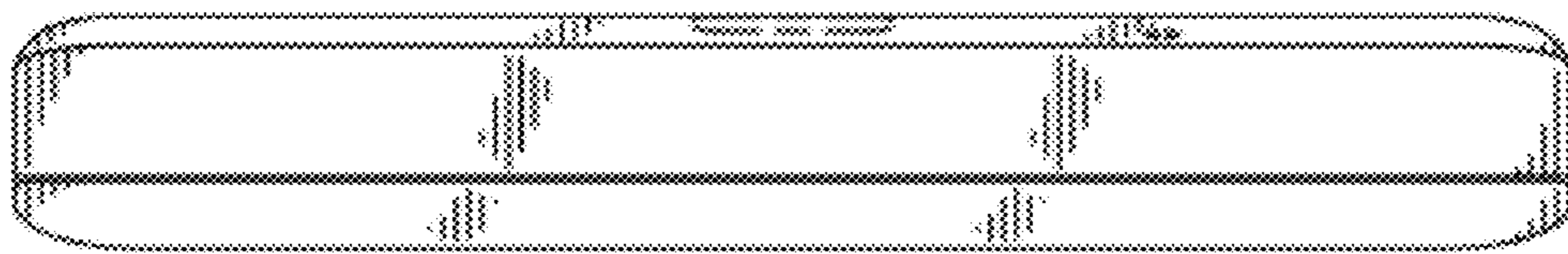

FIG. 7

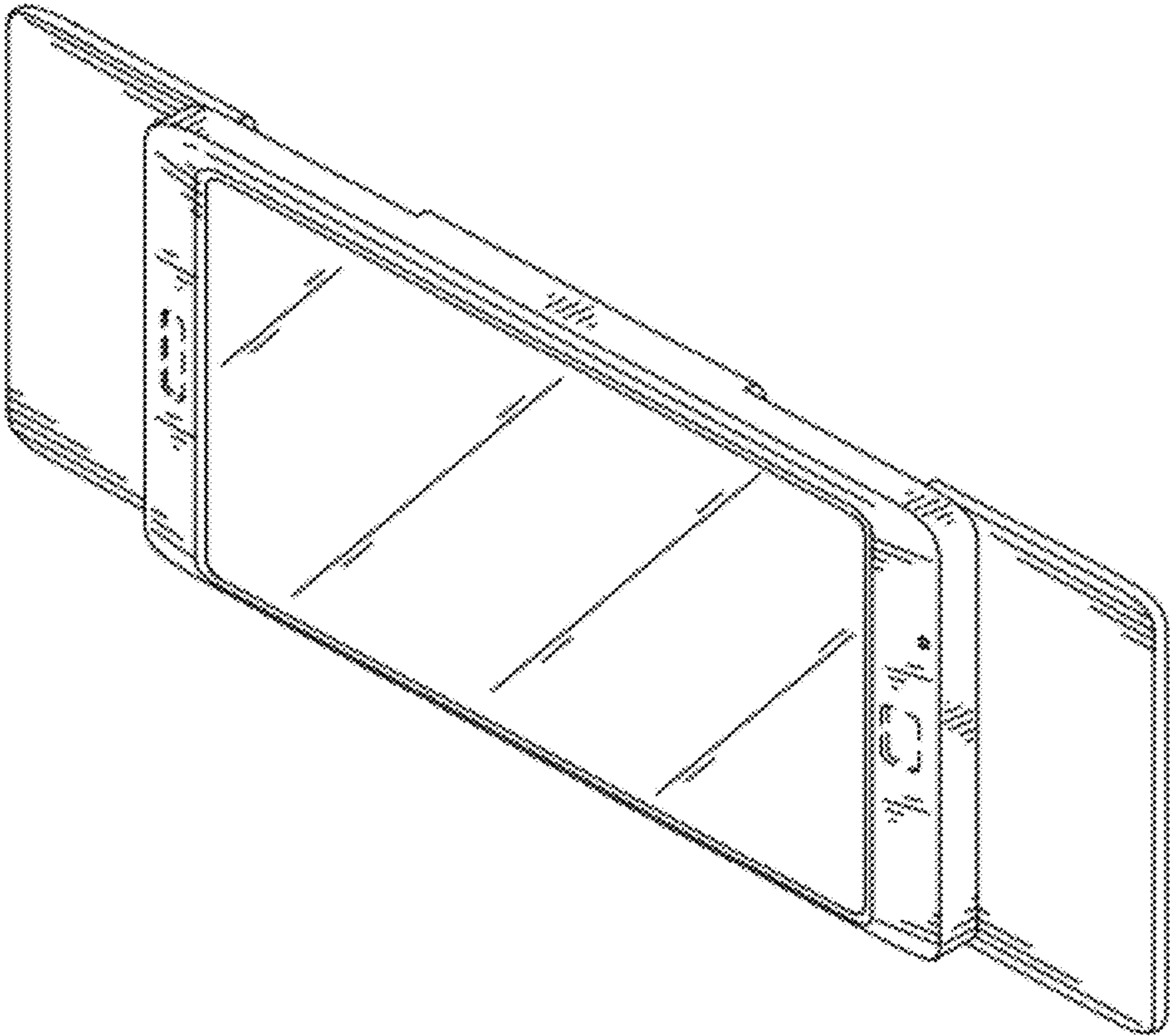

FIG. 8

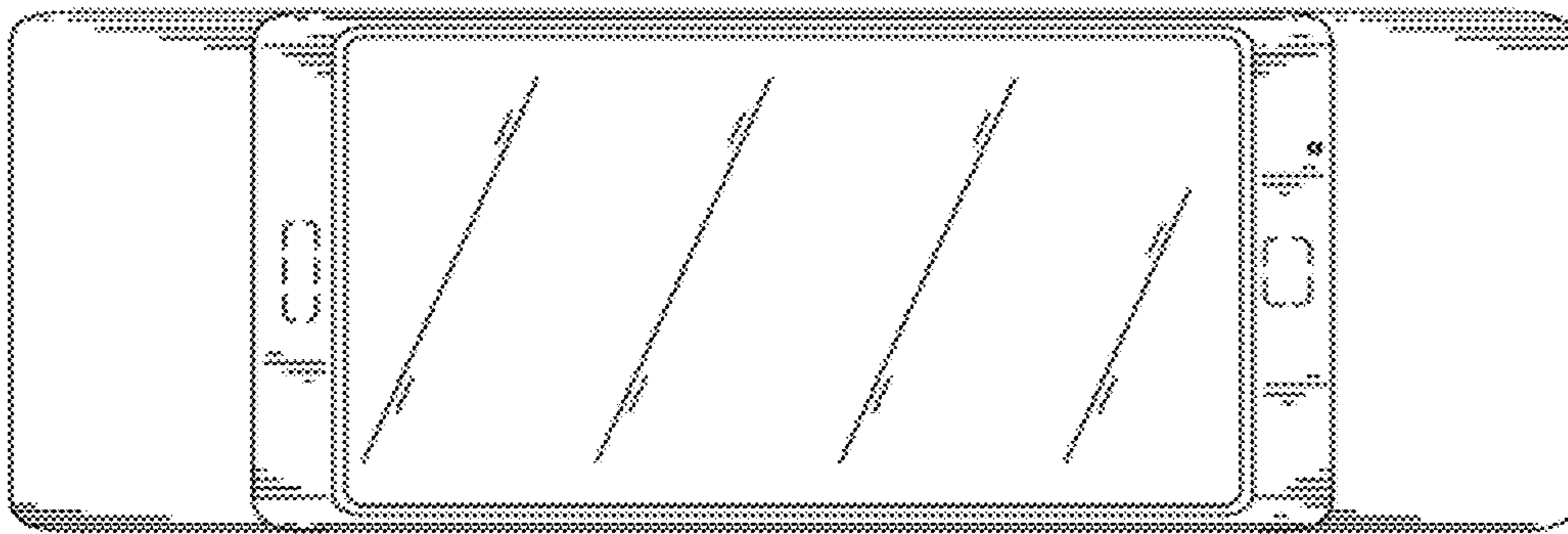

FIG. 9

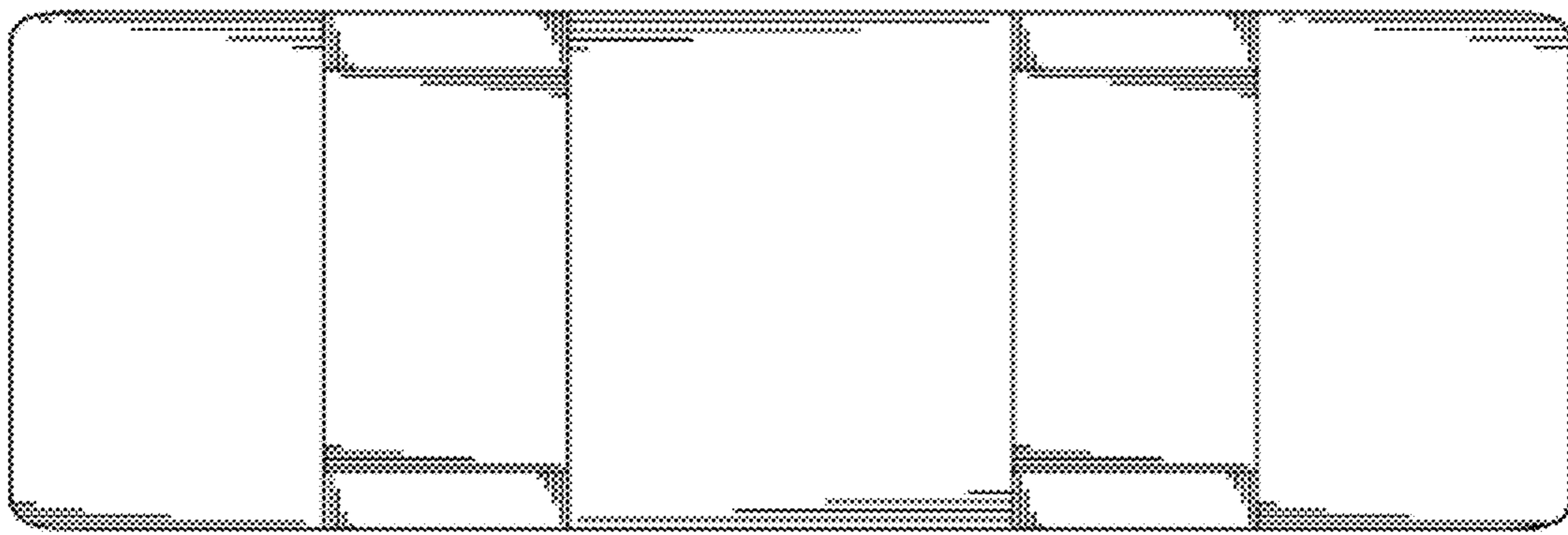

FIG. 10

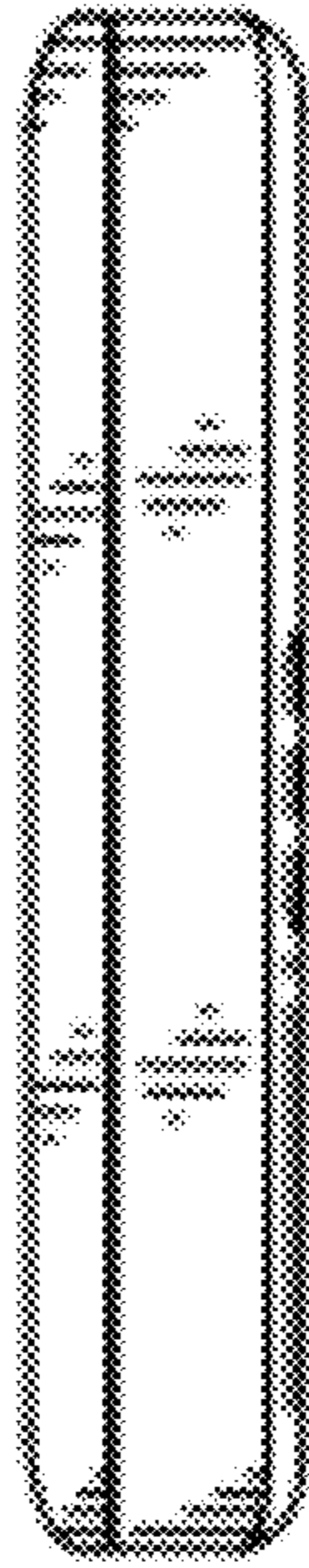

FIG. 11

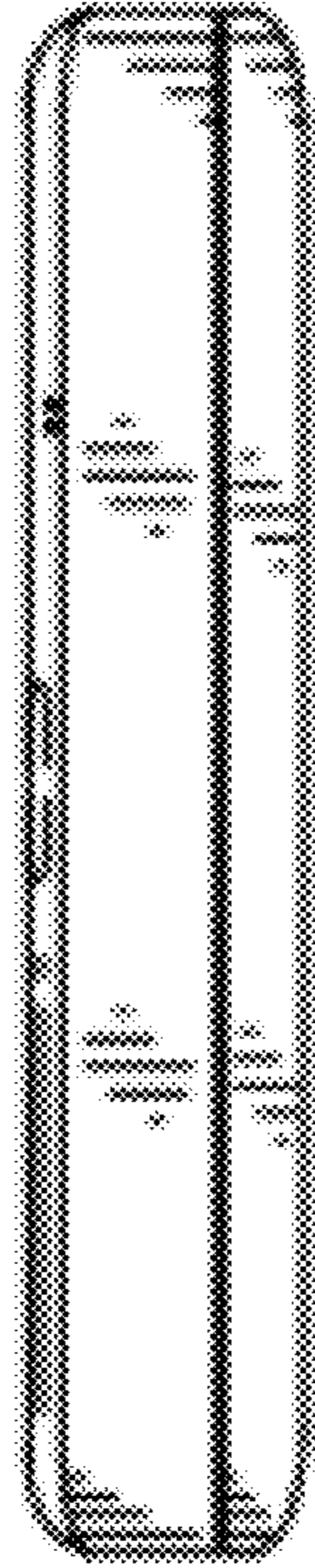

FIG. 12



FIG. 13

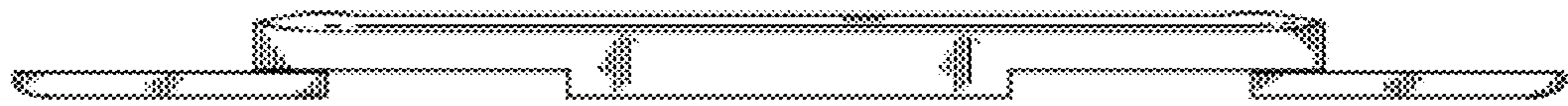

FIG. 14