



US00D654048S

(12) **United States Design Patent**  
**Ichinose et al.**

(10) **Patent No.:** **US D654,048 S**

(45) **Date of Patent:** **\*\* Feb. 14, 2012**

(54) **MOBILE PHONE**

(75) Inventors: **Tomoyoshi Ichinose**, Tokyo (JP);  
**Masuda Yuzuru**, Tokyo (JP);  
**Yoon-Young Cho**, Seoul (KR)

(73) Assignee: **Samsung Electronics Co., Ltd.** (KR)

(\*\*) Term: **14 Years**

(21) Appl. No.: **29/398,102**

(22) Filed: **Jul. 26, 2011**

(30) **Foreign Application Priority Data**

Apr. 27, 2011 (KR) ..... 30-2011-0017213

(51) **LOC (9) Cl.** ..... **14-03**

(52) **U.S. Cl.** ..... **D14/138 G**

(58) **Field of Classification Search** ..... D14/138 AD,  
D14/138 G, 138 R, 138 AC, 138 C, 496,  
D14/341, 345, 346, 203.7, 247, 248, 218,  
D14/138 AA, 138 AB; 455/575.1, 556.2,  
455/556.1, 575.4, 566; D10/65; D13/168

See application file for complete search history.

(56) **References Cited**

**U.S. PATENT DOCUMENTS**

D532,766 S \* 11/2006 Lee ..... D14/138 AD  
D580,387 S \* 11/2008 Andre et al. .... D14/138 G  
D601,539 S \* 10/2009 Hong ..... D14/138 G  
D606,958 S \* 12/2009 Knoppert et al. .... D14/138 AD  
D609,210 S \* 2/2010 Sohn et al. .... D14/138 AD  
D615,945 S \* 5/2010 Kim et al. .... D14/138 G  
D618,655 S \* 6/2010 Sandberg ..... D14/138 G  
D619,555 S \* 7/2010 Yang et al. .... D14/138 G  
D624,519 S \* 9/2010 Shen et al. .... D14/138 AD  
D626,937 S \* 11/2010 Yeo et al. .... D14/203.7  
D627,755 S \* 11/2010 Yang ..... D14/138 G

D628,975 S \* 12/2010 Jang ..... D14/138 G  
D629,773 S \* 12/2010 Lee et al. .... D14/138 G  
D629,799 S \* 12/2010 Andre et al. .... D14/341  
D633,066 S \* 2/2011 Park et al. .... D14/138 AD  
D633,460 S \* 3/2011 Yi et al. .... D14/138 G  
D633,886 S \* 3/2011 Chen ..... D14/138 AD  
D635,541 S \* 4/2011 Park et al. .... D14/138 G  
D638,815 S \* 5/2011 Lee et al. .... D14/138 G  
D640,658 S \* 6/2011 Knoppert et al. .... D14/138 G  
D643,827 S \* 8/2011 Lee et al. .... D14/138 G  
D644,197 S \* 8/2011 Lee et al. .... D14/138 G  
D645,010 S \* 9/2011 Lee et al. .... D14/138 G  
D645,014 S \* 9/2011 Chung ..... D14/138 G

(Continued)

**OTHER PUBLICATIONS**

Samsung Galaxy W I8150 telephone, announced Aug. 2011,  
[online]. [site visited Sep. 20, 2011]. Available from Internet, <URL:  
<http://www.gsmarena.com>>.\*

(Continued)

*Primary Examiner* — Jeffrey D Asch

(74) *Attorney, Agent, or Firm* — NSIP Law

(57) **CLAIM**

The ornamental design for a mobile phone, as shown and described.

**DESCRIPTION**

FIG. 1 is a perspective view of a mobile phone;  
FIG. 2 is a front view of the mobile phone of FIG. 1;  
FIG. 3 is a rear view of the mobile phone of FIG. 1;  
FIG. 4 is a left-side view of the mobile phone of FIG. 1;  
FIG. 5 is a right-side view of the mobile phone of FIG. 1;  
FIG. 6 is a top plan view of the mobile phone of FIG. 1; and,  
FIG. 7 is a bottom plan view of the mobile phone of FIG. 1.

**1 Claim, 5 Drawing Sheets**

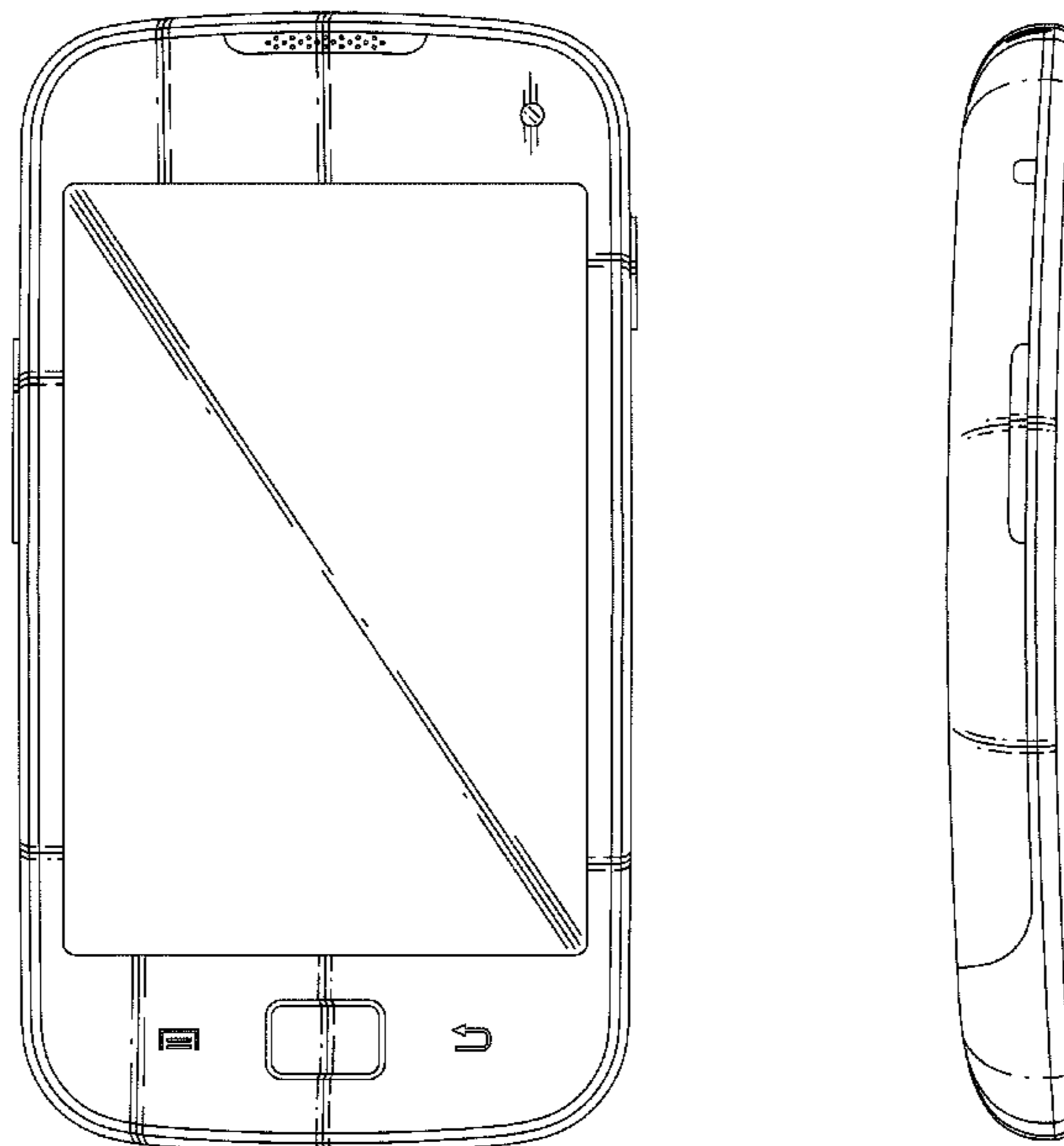

U.S. PATENT DOCUMENTS

D645,015 S \* 9/2011 Lee et al. .... D14/138 G  
D645,017 S \* 9/2011 Kim et al. .... D14/138 G

OTHER PUBLICATIONS

Samsung I9003 Galaxy SL telephone, announced Feb. 2011, [online], [site visited Sep. 20, 2011]. Available from Internet, <URL: <http://www.gsmarena.com>>.\*  
Samsung Galaxy Gio S5660 telephone, announced Jan. 2011, [online], [site visited Sep. 20, 2011]. Available from Internet, <URL: <http://www.gsmarena.com>>.\*  
Samsung Galaxy Ace S5830 telephone, announced Jan. 2011, [online], [site visited Sep. 20, 2011]. Available from Internet, <URL: <http://www.gsmarena.com>>.\*

Samsung B5722 telephone, announced Nov. 2009, [online], [site visited Sep. 20, 2011]. Available from Internet, <URL: <http://www.gsmarena.com>>.\*

Motorola EX128 telephone, announced Oct. 2010, [online], [site visited Sep. 20, 2011]. Available from Internet, <URL: <http://www.gsmarena.com>>.\*

Spice M-6800 Flo telephone, announced May 2011, [online], [site visited Sep. 20, 2011]. Available from Internet, <URL: <http://www.gsmarena.com>>.\*

ZTE F951 telephone, announced 2010, [online], [site visited Sep. 20, 2011]. Available from Internet, <URL: <http://www.gsmarena.com>>.\*

\* cited by examiner

FIG. 1

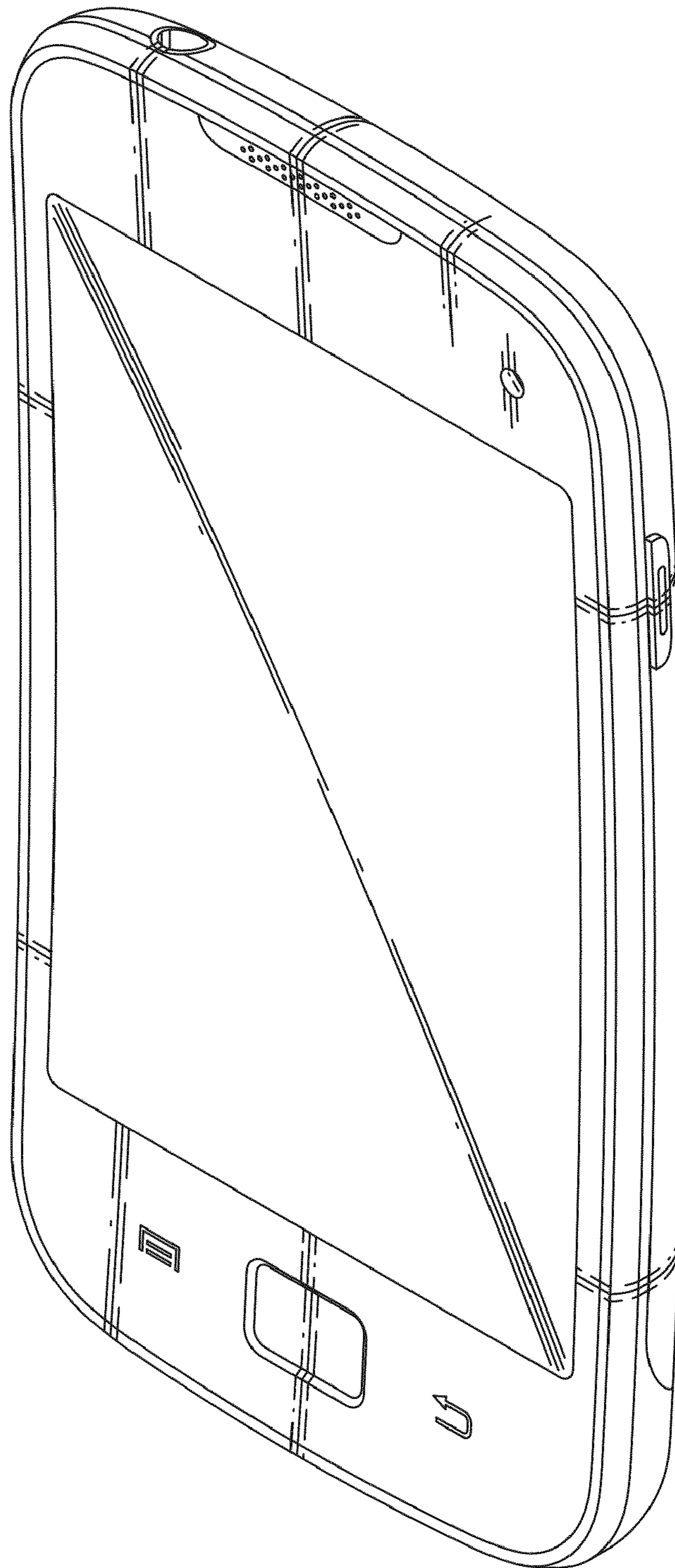

FIG. 2

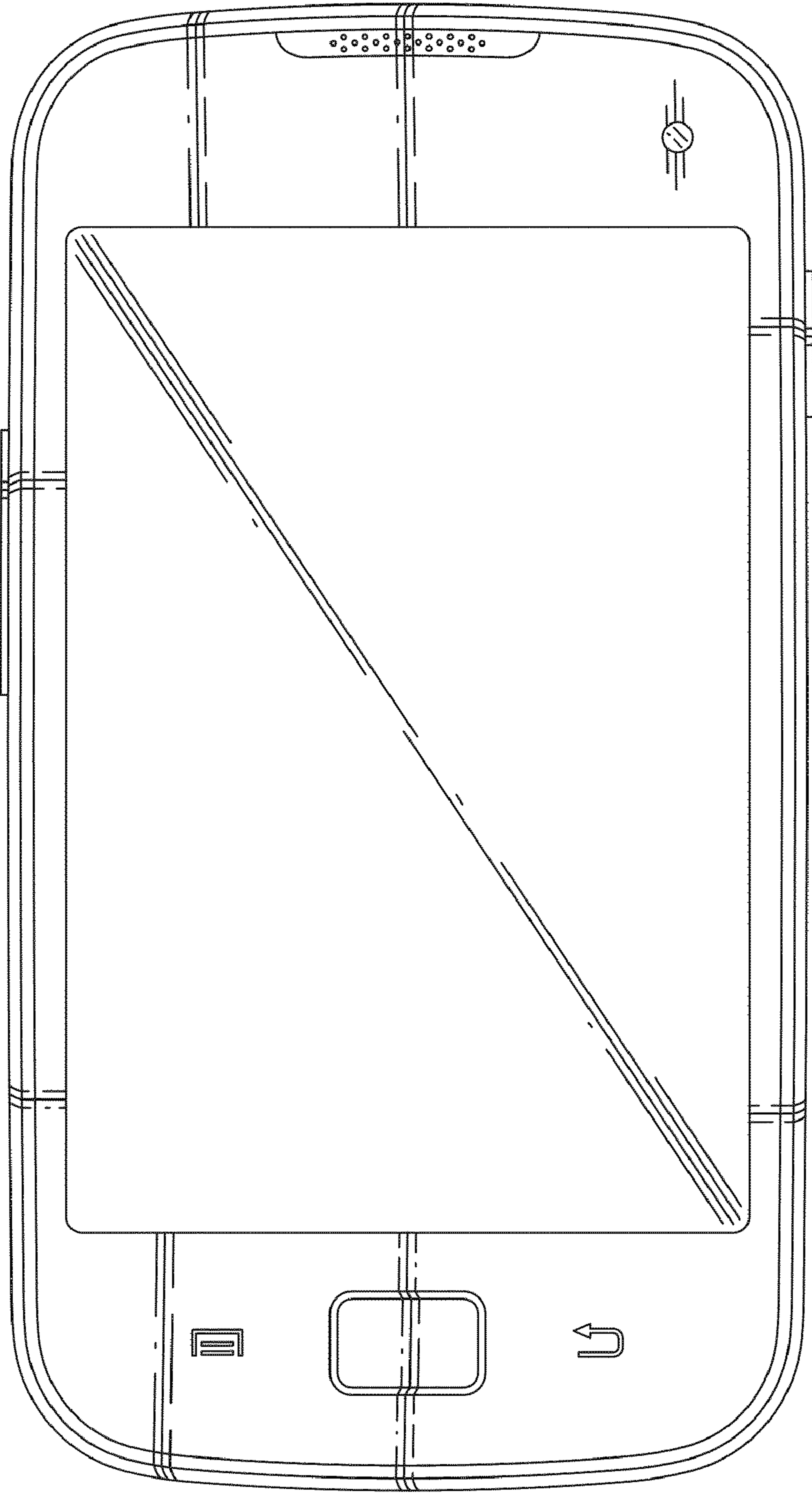

FIG. 3

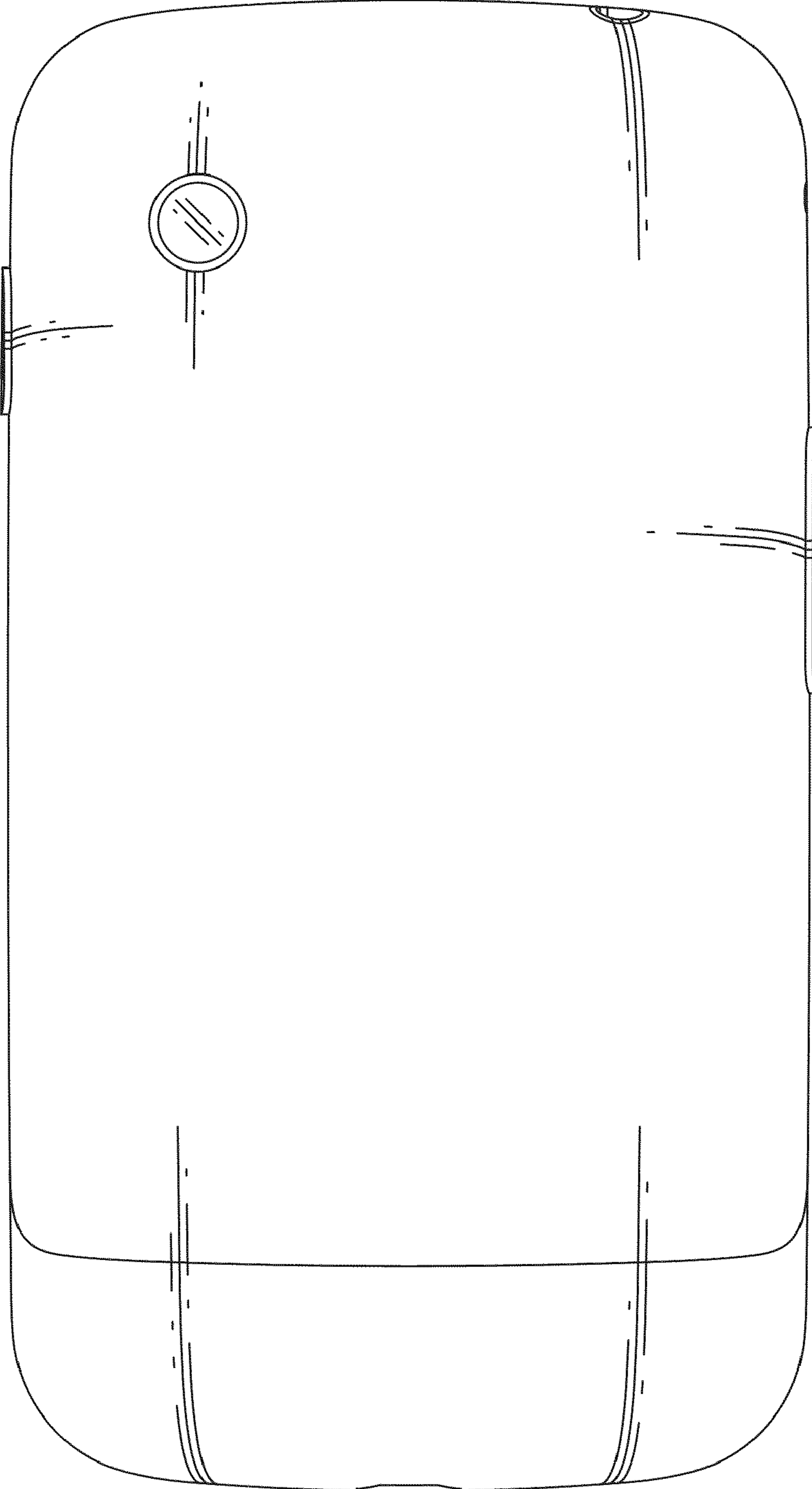

FIG. 4

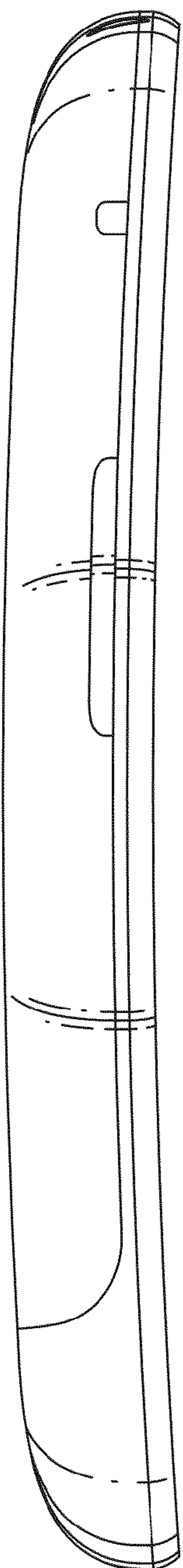

FIG. 5

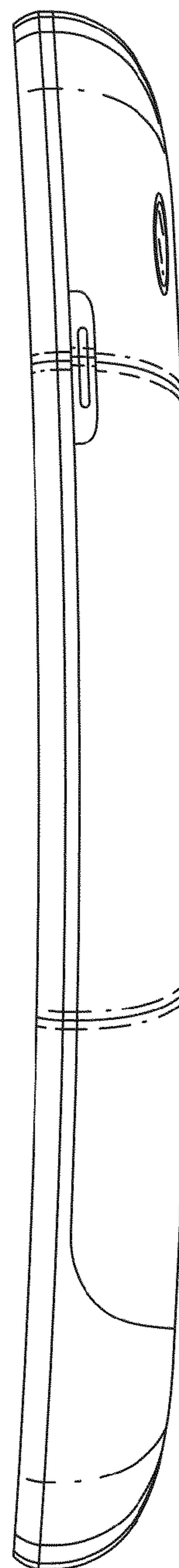

FIG. 6

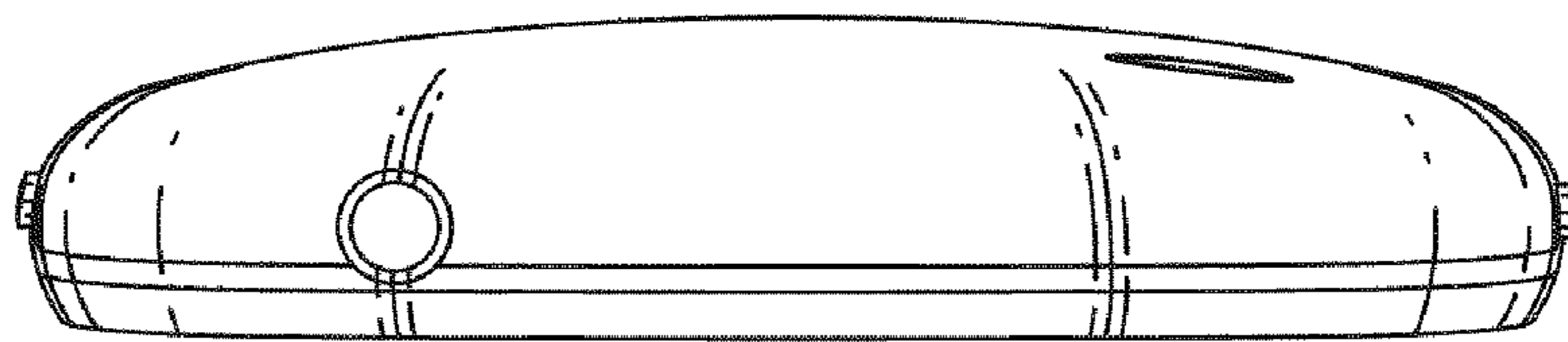

FIG. 7

