



US00D654046S

(12) **United States Design Patent**  
**Shin et al.**

(10) **Patent No.:** **US D654,046 S**

(45) **Date of Patent:** **\*\* Feb. 14, 2012**

(54) **CELLULAR PHONE**

(75) Inventors: **Jihoon Shin**, Seoul (KR); **Hyunseung Seo**, Seoul (KR)

(73) Assignee: **LG Electronics Inc.**, Seoul (KR)

(\*\*) Term: **14 Years**

(21) Appl. No.: **29/391,899**

(22) Filed: **May 13, 2011**

(30) **Foreign Application Priority Data**

Dec. 9, 2010 (KR) ..... 30-2010-0053523

(51) **LOC (9) Cl.** ..... **14-03**

(52) **U.S. Cl.** ..... **D14/138 AD**

(58) **Field of Classification Search** ..... D14/138 AD,  
D14/138 G, 138 R, 138 AC, 138 C, 496,  
D14/341, 345, 346, 203.7, 247, 248, 218,  
D14/138 AA, 138 AB; 455/575.1, 556.2,  
455/556.1, 575.4, 566; D10/65; D13/168

See application file for complete search history.

(56) **References Cited**

**U.S. PATENT DOCUMENTS**

D509,203 S *	9/2005	Bertrand et al. ....	D14/138 AD
D527,364 S *	8/2006	Lee et al. ....	D14/138 AD
D533,533 S *	12/2006	Kim et al. ....	D14/138 AD
D558,177 S *	12/2007	Han et al. ....	D14/138 AD
D560,191 S *	1/2008	Choi et al. ....	D14/138 AD
D562,294 S *	2/2008	Bang et al. ....	D14/138 AD
D563,370 S *	3/2008	Choi et al. ....	D14/138 AD
D569,836 S *	5/2008	Han et al. ....	D14/138 AD
D570,322 S *	6/2008	Lyles .....	D14/138 AD
D590,803 S *	4/2009	Rihu .....	D14/138 AD
D591,701 S *	5/2009	Lee et al. ....	D14/138 AD
D608,330 S *	1/2010	Jeoung et al. ....	D14/138 AD
D618,654 S *	6/2010	Lee et al. ....	D14/138 AD
D620,469 S *	7/2010	Chang .....	D14/138 AD
D620,913 S *	8/2010	Kim et al. ....	D14/138 AD
D628,181 S *	11/2010	Kim et al. ....	D14/138 AD

7,877,119 B2 *	1/2011	Kim .....	455/575.1
D633,466 S *	3/2011	Kim et al. ....	D14/138 AD
D633,891 S *	3/2011	Park et al. ....	D14/138 AD
7,983,725 B2 *	7/2011	Zhang et al. ....	455/575.4
2005/0245297 A1 *	11/2005	Lee et al. ....	455/575.4
2005/0250532 A1 *	11/2005	Hwang et al. ....	455/550.1
2007/0071232 A1 *	3/2007	Chung .....	379/433.07
2010/0160010 A1 *	6/2010	Ladouceur et al. ....	455/575.4
2011/0105204 A1 *	5/2011	Kouno .....	455/575.4

**OTHER PUBLICATIONS**

Samsung L760 telephone, announced Jul. 2007, [online], [site visited Sep. 20, 2011]. Available from Internet, <URL: <http://www.gsmarena.com>>.\*

Samsung M610 telephone, announced Oct. 2007, [online], [site visited Sep. 20, 2011]. Available from Internet, <URL: <http://www.gsmarena.com>>.\*

LG GU292 telephone, announced May 2010, [online], [site visited Sep. 20, 2011]. Available from Internet, <URL: <http://www.gsmarena.com>>.\*

\* cited by examiner

*Primary Examiner* — Jeffrey D Asch

(74) *Attorney, Agent, or Firm* — Birch, Stewart, Kolasch & Birch, LLP

(57) **CLAIM**

The ornamental design for a cellular phone, as shown and described.

**DESCRIPTION**

FIG. 1 is a top, front, perspective view of a cellular phone showing our new design;

FIG. 2 is a front view thereof;

FIG. 3 is a rear view thereof;

FIG. 4 is a left side view thereof;

FIG. 5 is a right side view thereof;

FIG. 6 is a top view thereof;

FIG. 7 is a bottom view thereof; and,

FIG. 8 is an open front view thereof.

**1 Claim, 8 Drawing Sheets**

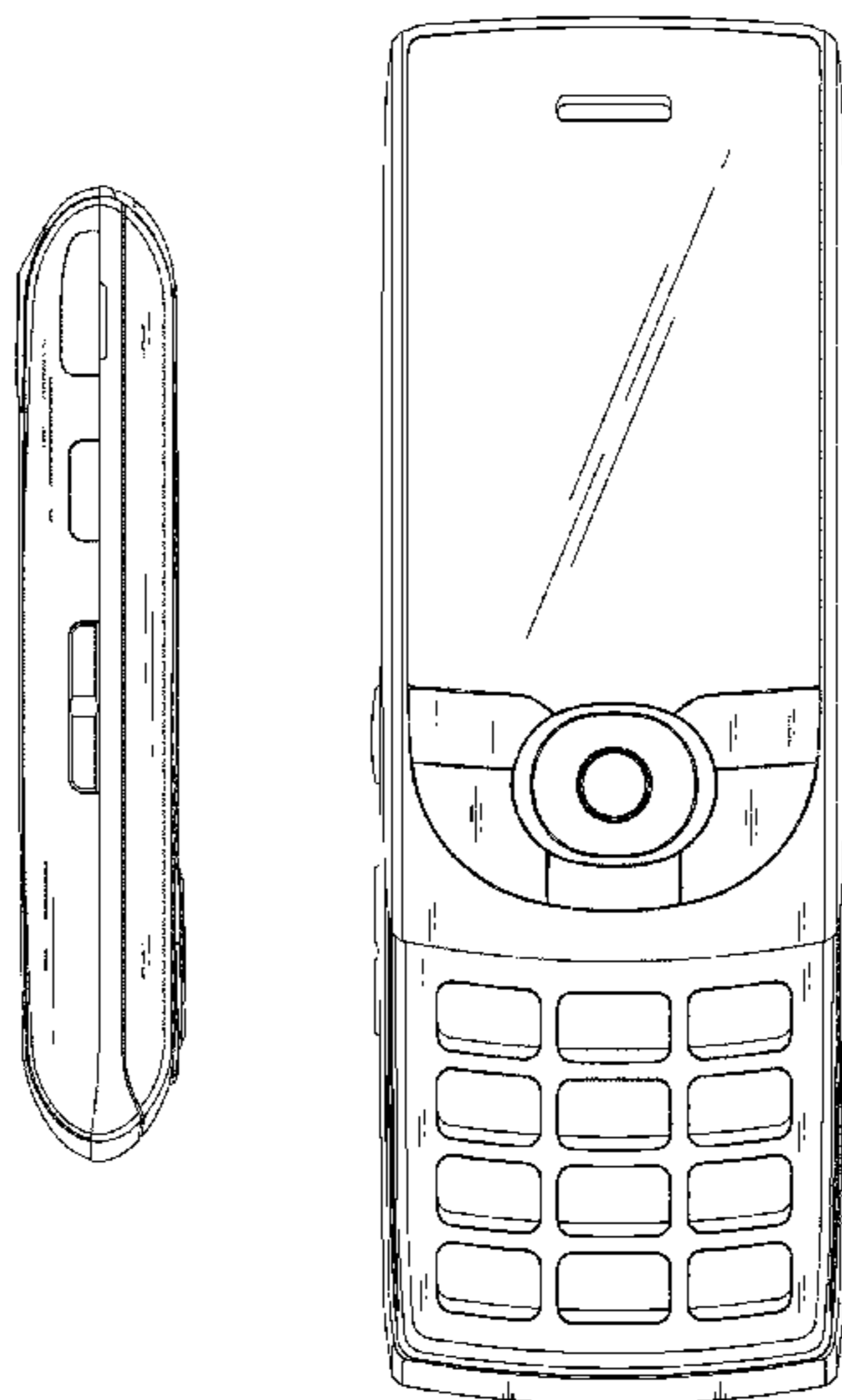

FIG. 1

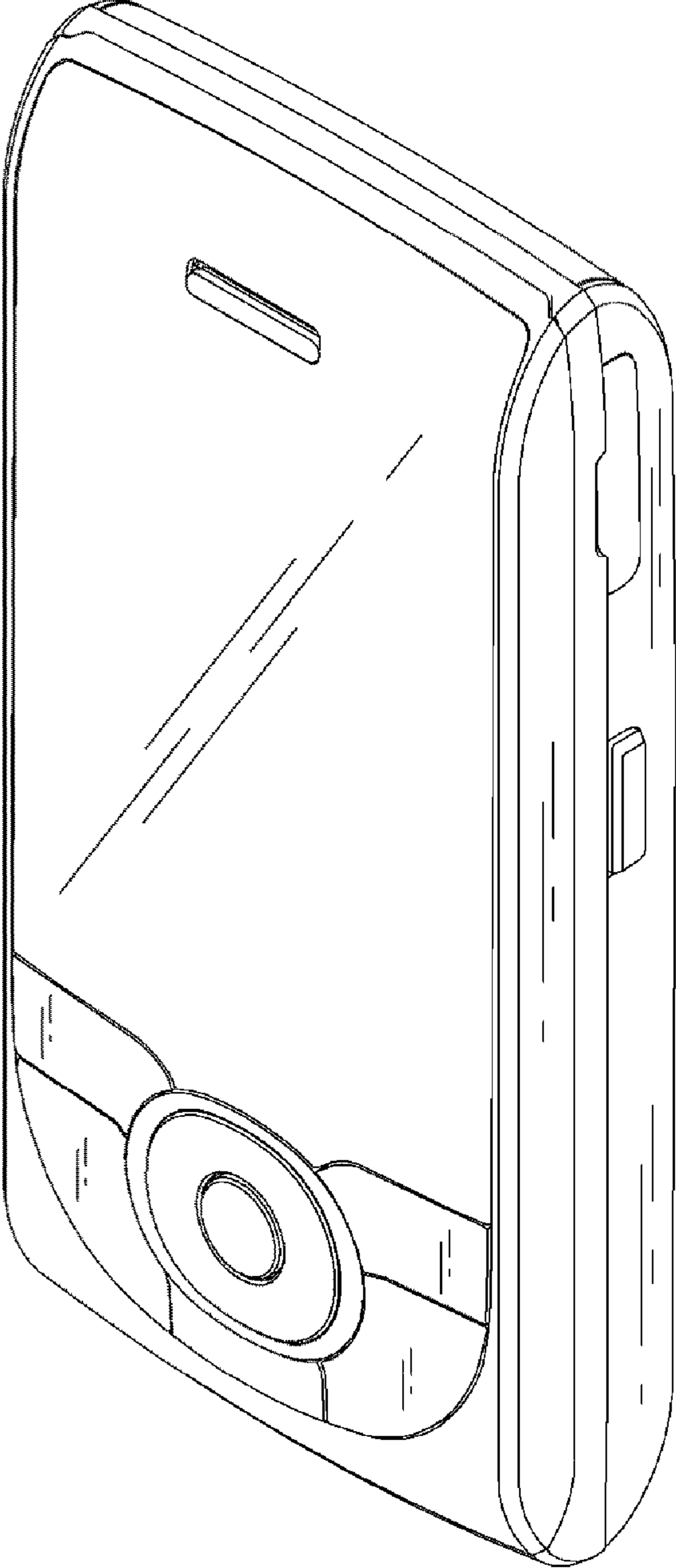

FIG. 2

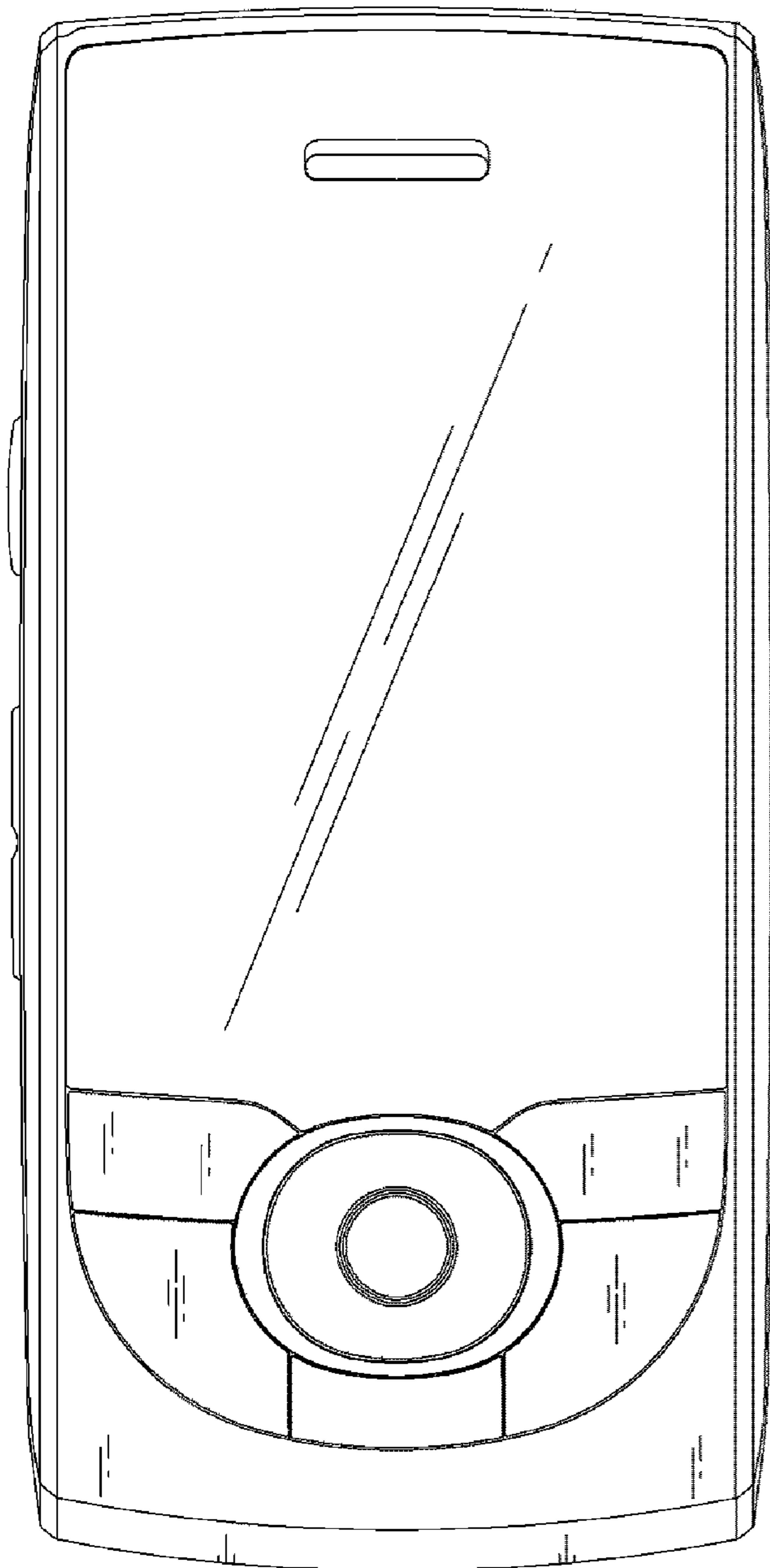

FIG. 3

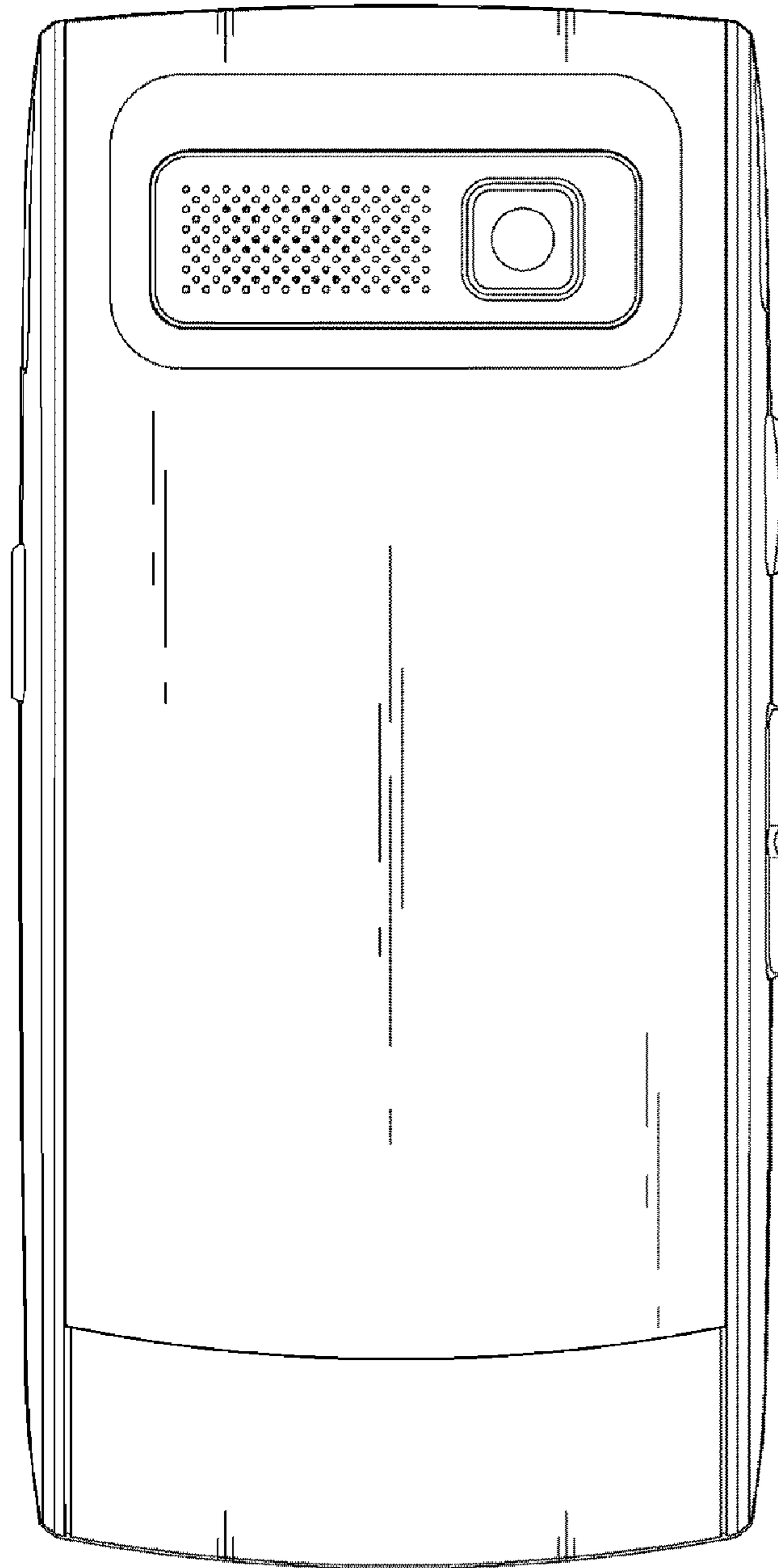

FIG. 4

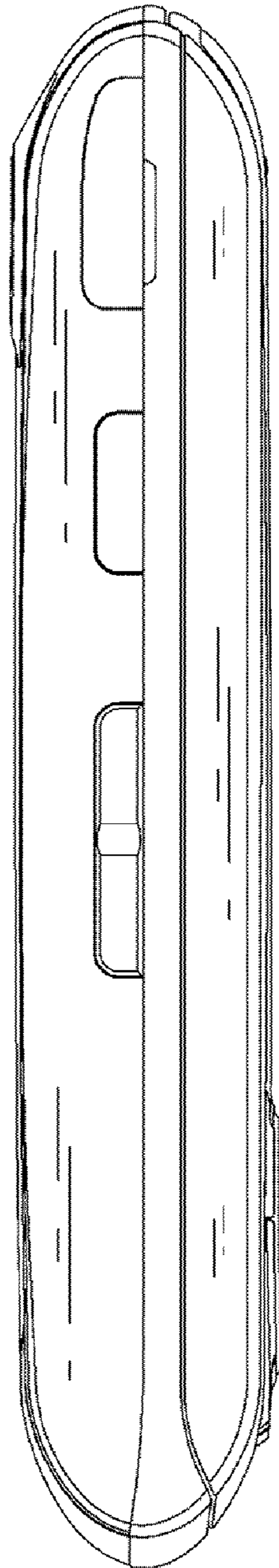

FIG. 5

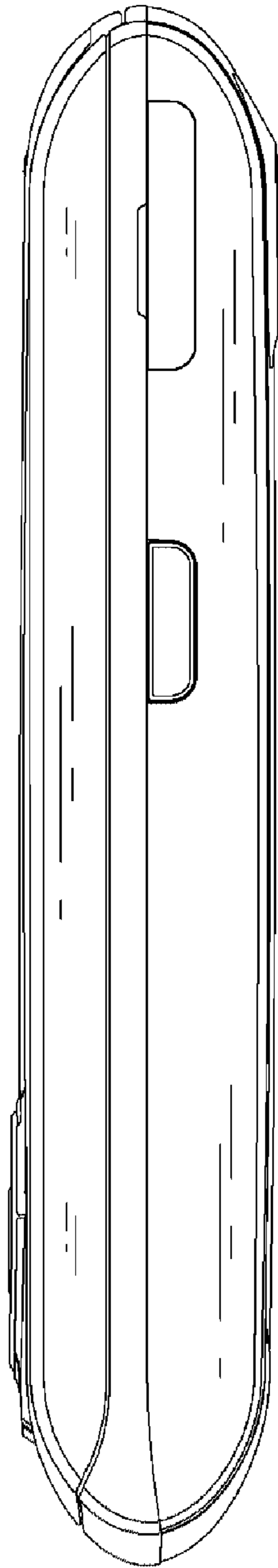

FIG. 6

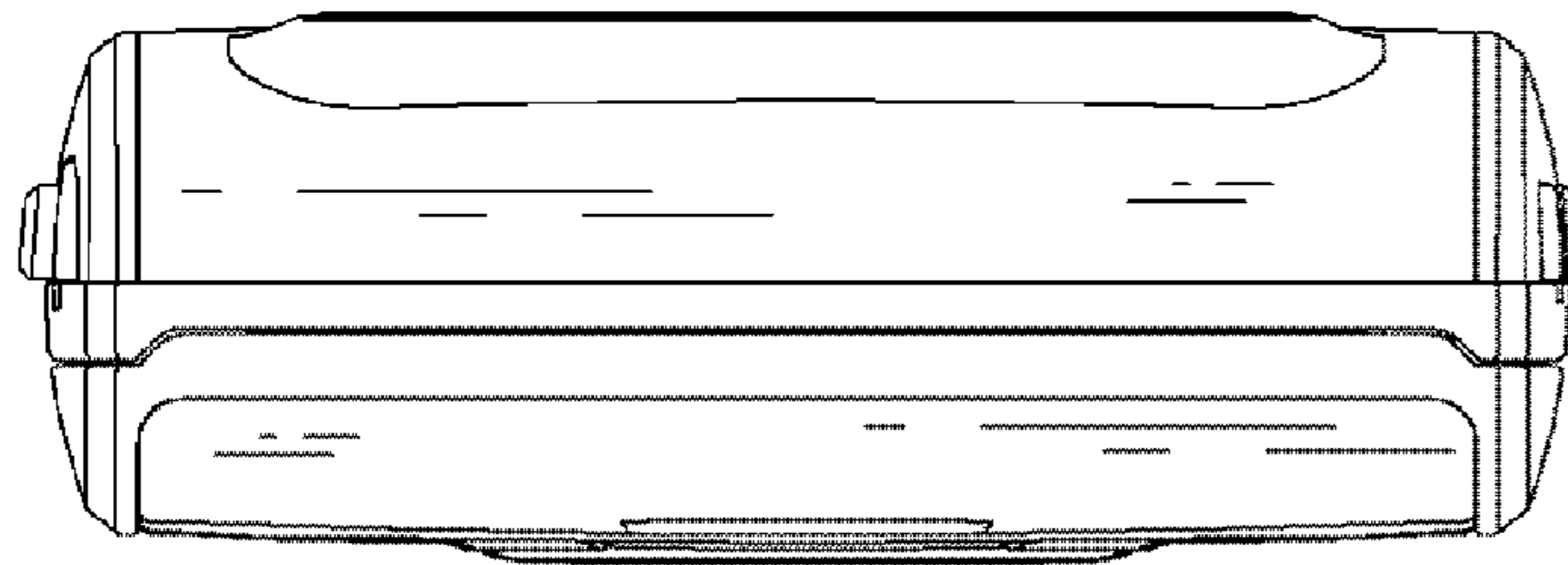

FIG. 7





FIG. 8

