



US00D654044S

(12) **United States Design Patent**
Kim et al.

(10) **Patent No.:** **US D654,044 S**

(45) **Date of Patent:** **** Feb. 14, 2012**

(54) **MOBILE PHONE**

(75) Inventors: **Kuk-Hwan Kim**, Seoul (KR); **Nam-Mi Kim**, Seoul (KR); **Seog-Guen Kim**, Seoul (KR)

(73) Assignee: **Samsung Electronics Co., Ltd.**, Suwon-Si (KR)

(**) Term: **14 Years**

(21) Appl. No.: **29/389,170**

(22) Filed: **Apr. 7, 2011**

(30) **Foreign Application Priority Data**

Dec. 29, 2010 (KR) 30-2010-0056514

(51) **LOC (9) Cl.** **14-03**

(52) **U.S. Cl.** **D14/138 AD**

(58) **Field of Classification Search** D14/138 AD, D14/138 G, 138 R, 138 AC, 138 C, 496, D14/341, 345, 346, 203.7, 247, 248, 218, D14/138 AA, 138 AB; 455/575.1, 556.2, 455/556.1, 575.4, 566; D10/65; D13/168

See application file for complete search history.

(56) **References Cited**

U.S. PATENT DOCUMENTS

D535,275 S *	1/2007	Kim et al.	D14/138 AD
D558,176 S *	12/2007	Lee et al.	D14/138 AD
D560,199 S *	1/2008	Lee et al.	D14/138 AD
D561,725 S *	2/2008	Kim et al.	D14/138 AD
D562,291 S *	2/2008	Bang et al.	D14/138 AD
D563,934 S *	3/2008	Jung et al.	D14/138 AD
D574,353 S *	8/2008	Park et al.	D14/138 AD
D576,595 S *	9/2008	Han et al.	D14/138 AD
D576,986 S *	9/2008	Kim et al.	D14/138 AD
D582,369 S *	12/2008	Jeoung et al.	D14/138 AD

D590,803 S *	4/2009	Rihu	D14/138 AD
D591,714 S *	5/2009	Kim et al.	D14/138 AD
D593,531 S *	6/2009	Lee et al.	D14/138 AD
D599,320 S *	9/2009	Sterzick et al.	D14/138 AD
D601,111 S *	9/2009	Sterzick et al.	D14/138 AD
D605,619 S *	12/2009	Lee et al.	D14/138 AD
D611,026 S *	3/2010	Kim et al.	D14/138 AD
D617,759 S *	6/2010	Leinvuo et al.	D14/138 AD
D618,654 S *	6/2010	Lee et al.	D14/138 AD
D619,114 S *	7/2010	Lu	D14/138 AD

(Continued)

OTHER PUBLICATIONS

Samsung i520 telephone, announced Feb. 2007, [online], [site visited Sep. 20, 2011]. Available from Internet, <URL: <http://www.gsmarena.com>>.*

(Continued)

Primary Examiner — Jeffrey D Asch

(74) *Attorney, Agent, or Firm* — Staas & Halsey LLP

(57) **CLAIM**

The ornamental design for a mobile phone, as shown and described.

DESCRIPTION

FIG. 1 is a front perspective view of a mobile phone; FIG. 2 is a front view of the mobile phone of FIG. 1; FIG. 3 is a rear view of the mobile phone of FIG. 1; FIG. 4 is a left-side view of the mobile phone of FIG. 1; FIG. 5 is a right-side view of the mobile phone of FIG. 1; FIG. 6 is a top plan view of the mobile phone of FIG. 1; FIG. 7 is a bottom plan view of the mobile phone of FIG. 1; and, FIG. 8 is an open front perspective view of the mobile phone of FIG. 1.

1 Claim, 8 Drawing Sheets

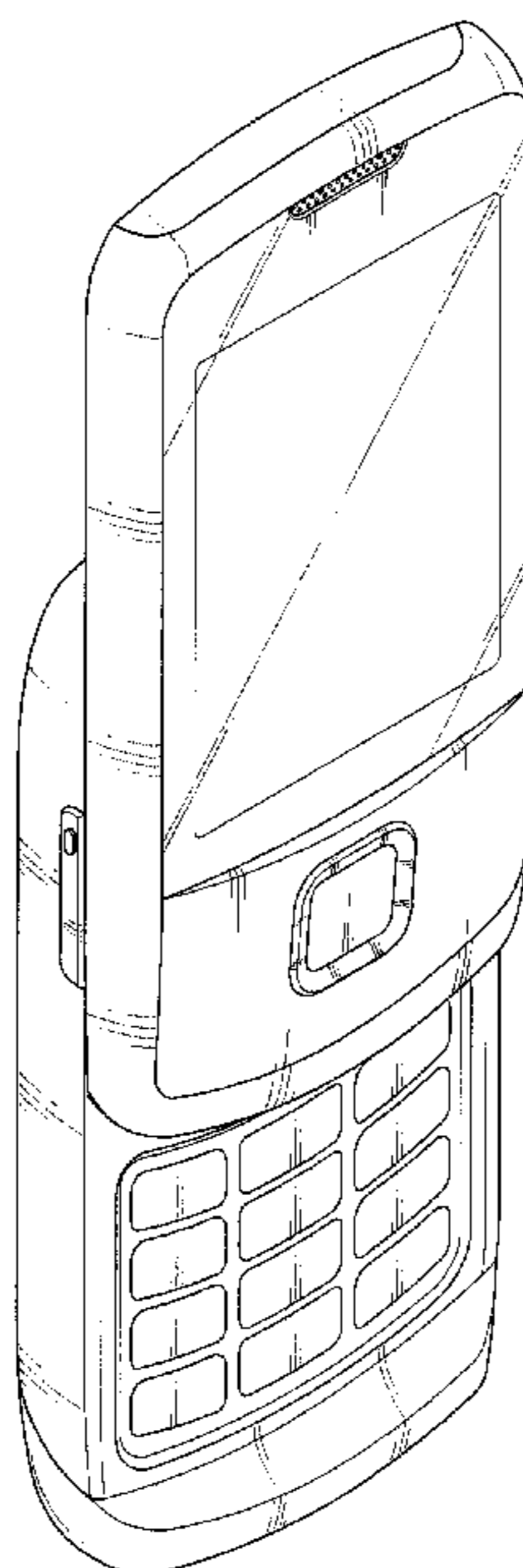
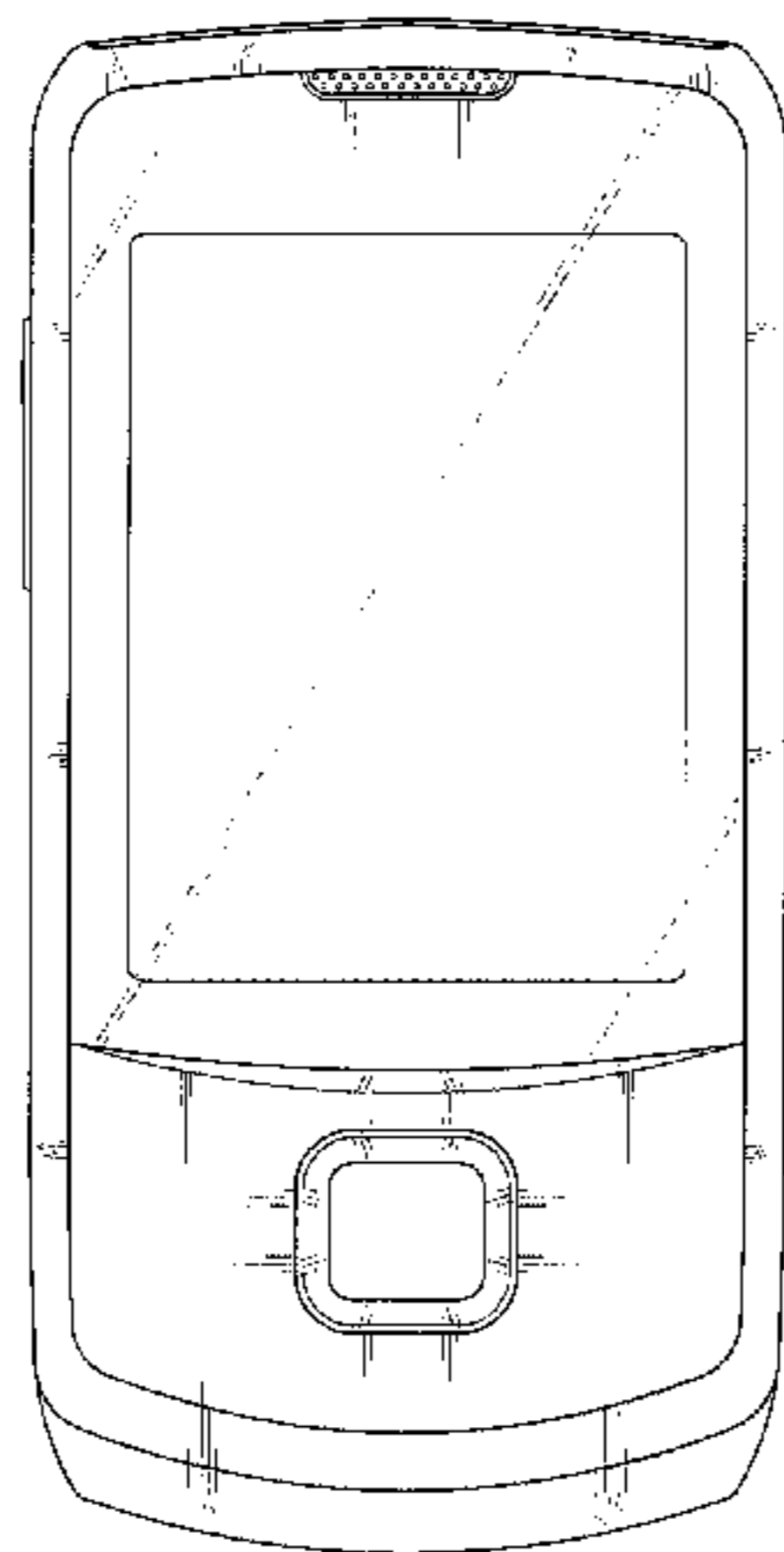

U.S. PATENT DOCUMENTS

D623,624 S * 9/2010 Joung et al. D14/138 AD
D633,466 S * 3/2011 Kim et al. D14/138 AD
7,953,464 B2 * 5/2011 Park et al. 455/575.4
D645,438 S * 9/2011 Chung D14/138 AD

OTHER PUBLICATIONS

Samsung S7350 Ultra s telephone, announced Feb. 2009, [online], [site visited Sep. 20, 2011]. Available from Internet, <URL: <http://www.gsmarena.com>>.*

Nokia E66 telephone, announced Jun. 2008, [online], [site visited Sep. 20, 2011]. Available from Internet, <URL: <http://www.gsmarena.com>>.*

LG KE500 telephone, announced Jul. 2007, [online], [site visited Sep. 20, 2011]. Available from Internet, <URL: <http://www.gsmarena.com>>.*

LG GU200 telephone, announced 2010, [online], [site visited Sep. 20, 2011]. Available from Internet, <URL: <http://www.gsmarena.com>>.*

LG GU230 Dimsun telephone, announced Oct. 2009, [online], [site visited Sep. 20, 2011]. Available from Internet, <URL: <http://www.gsmarena.com>>.*

Philips X510 telephone, announced Apr. 2010, [online], [site visited Sep. 20, 2011]. Available from Internet, <URL: <http://www.gsmarena.com>>.*

Sagem my721Z telephone, announced Feb. 2008, [online], [site visited Sep. 20, 2011]. Available from Internet, <URL: <http://www.gsmarena.com>>.*

* cited by examiner

FIG. 1

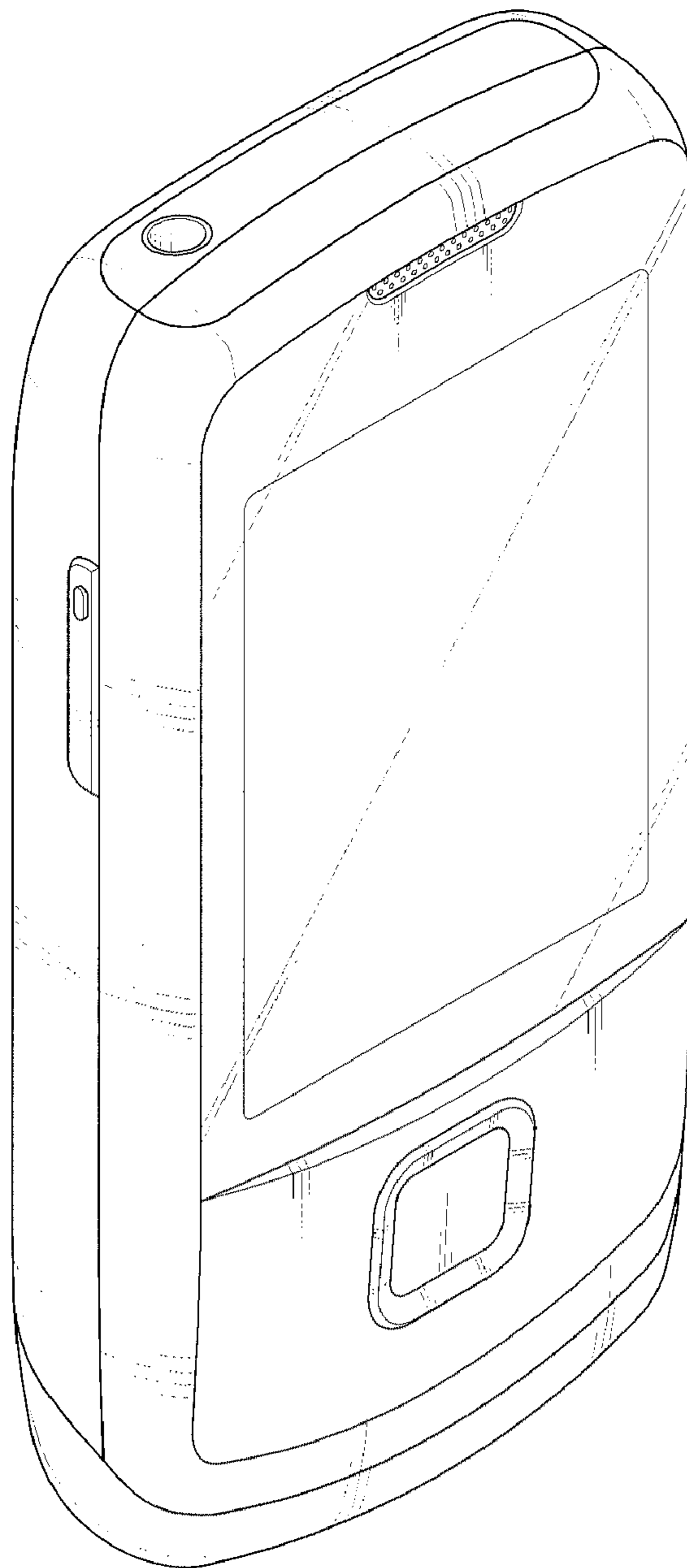

FIG. 2

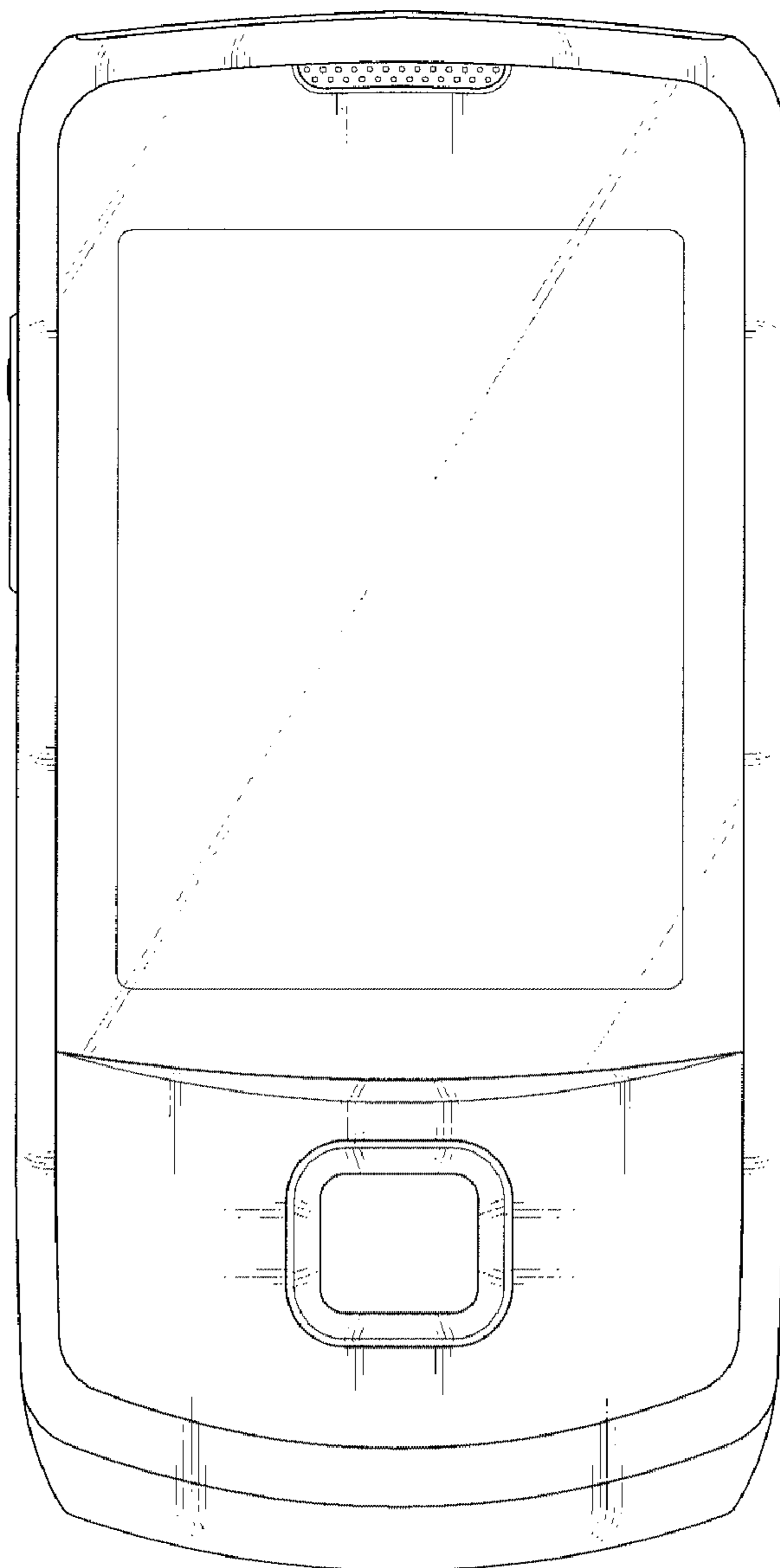

FIG. 3

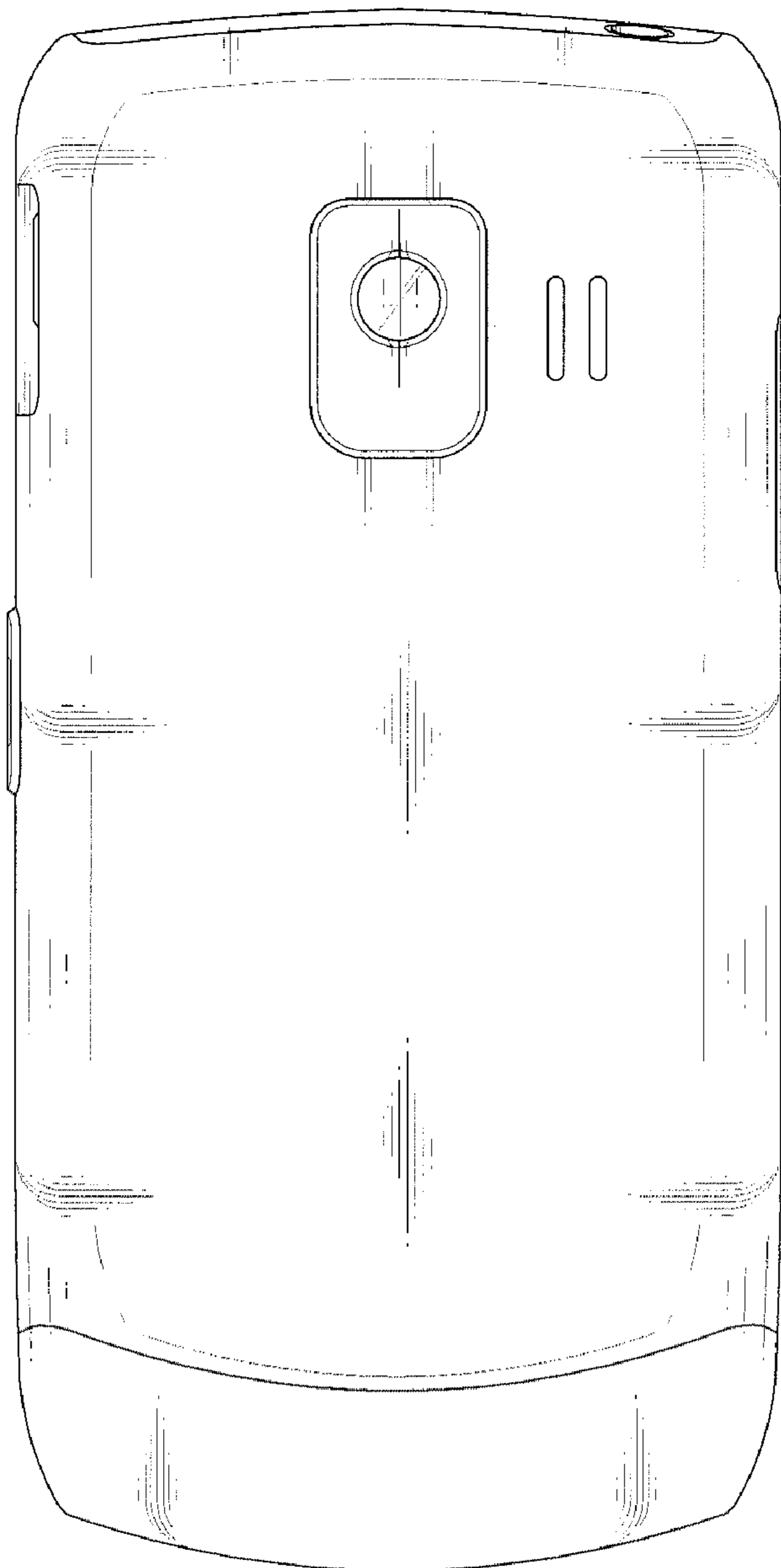

FIG. 4

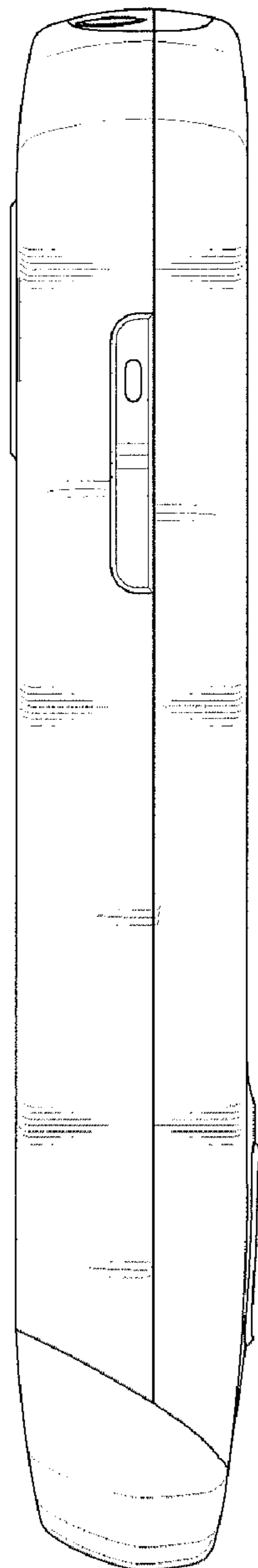

FIG. 5

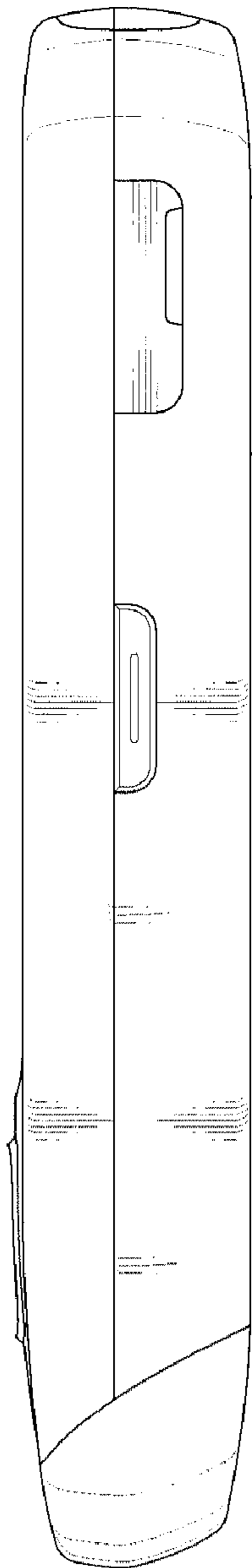

FIG. 6

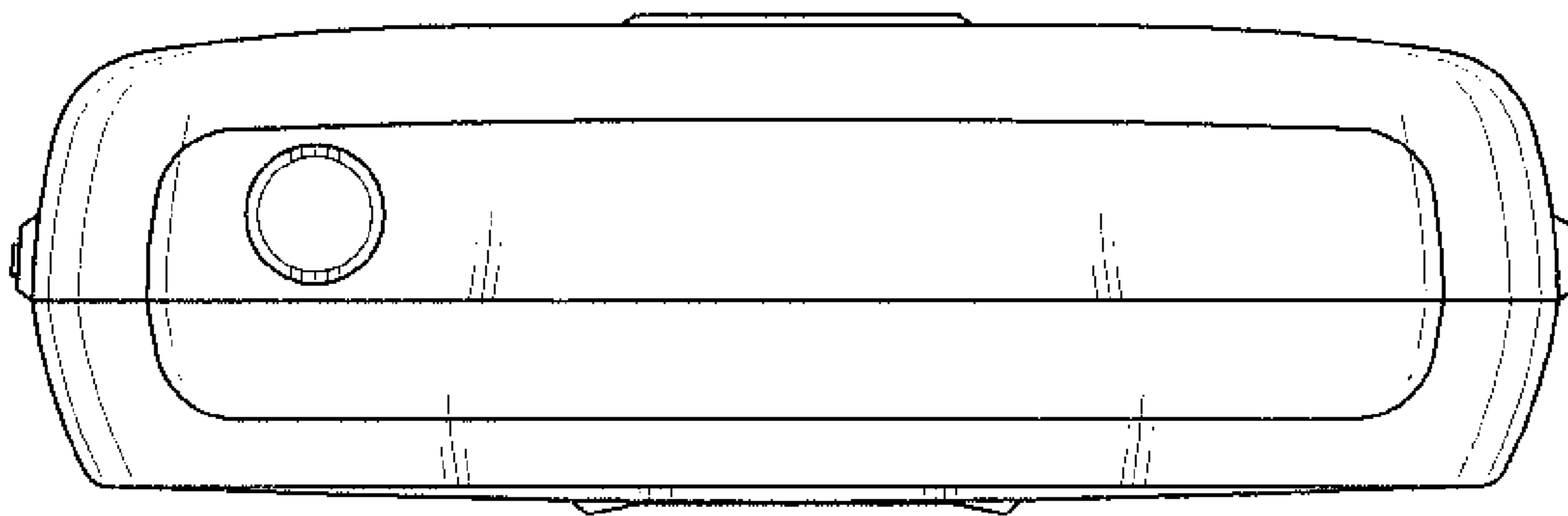

FIG. 7

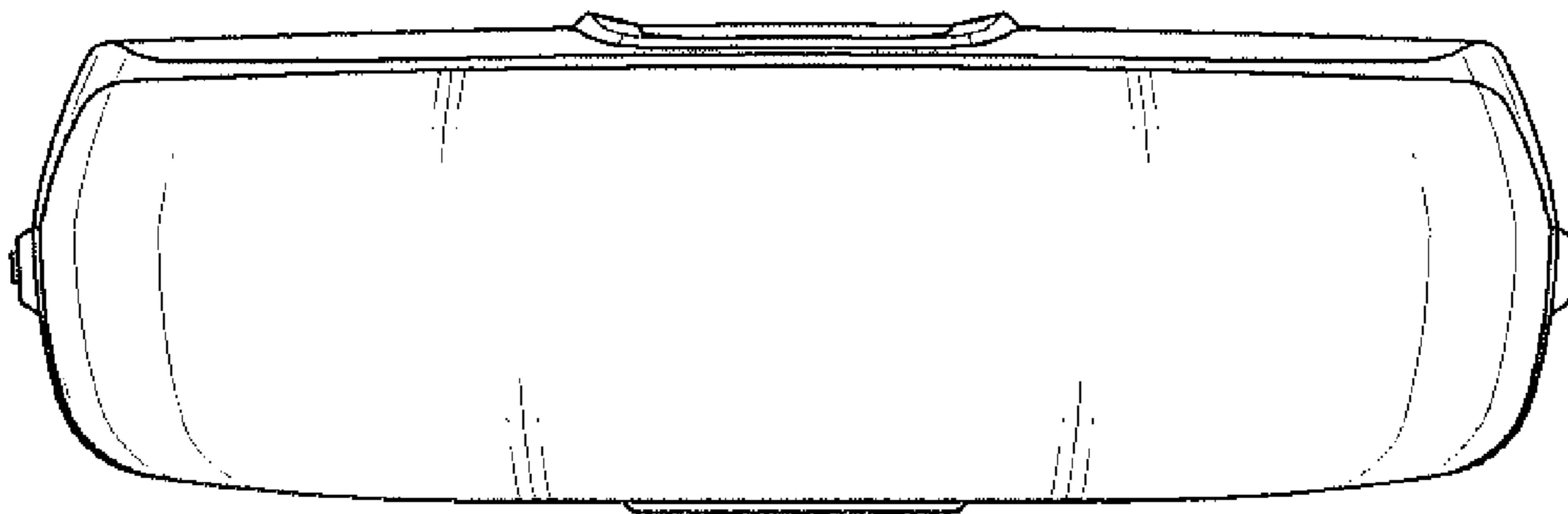

FIG. 8

