



US00D653919S

(12) **United States Design Patent**  
**Ward et al.**

(10) **Patent No.:** **US D653,919 S**

(45) **Date of Patent:** **\*\* Feb. 14, 2012**

(54) **SHRUB COVER**

(75) Inventors: **Bryan D. Ward**, Toronto (CA); **David W. Parker**, Innisfil (CA)

(73) Assignee: **NuVue Products**, Toronto, Ontario (CA)

(\*\*) Term: **14 Years**

(21) Appl. No.: **29/376,819**

(22) Filed: **Oct. 13, 2010**

(51) **LOC (9) Cl.** ..... **08-01**

(52) **U.S. Cl.** ..... **D8/1**

(58) **Field of Classification Search** ..... D8/1; 47/31,  
47/33, 29.2, 30, 19.1, 32.4, 32.7, 41.01, 41.1,  
47/44-47, 48.5, 79, 24, 86; D23/214; D21/253;  
D25/16; 135/126

See application file for complete search history.

(56) **References Cited**

U.S. PATENT DOCUMENTS

D33,787	S	*	12/1900	Meiners	.....	D23/249
1,112,052	A	*	9/1914	Campbell	.....	47/20.1
1,600,749	A	*	9/1926	Barnes	.....	47/23.2
D77,232	S	*	12/1928	Graffenberger	.....	D8/1
1,814,339	A	*	7/1931	Sato	.....	47/29.2
1,978,921	A	*	10/1934	Wade	.....	47/31
2,141,484	A	*	12/1938	Piglia	.....	47/30
D161,231	S	*	12/1950	Alvarez	.....	D8/1
3,214,865	A	*	11/1965	Rosenvold et al.	.....	47/29.2
5,456,043	A	*	10/1995	Dacon, Sr.	.....	47/23.2
5,509,229	A	*	4/1996	Thomasson et al.	.....	47/29.2
5,605,008	A	*	2/1997	Johnston et al.	.....	47/29.2
5,613,320	A	*	3/1997	Thomasson et al.	.....	47/32.1
D399,713	S	*	10/1998	Allen et al.	.....	D8/1
D408,233	S	*	4/1999	Price	.....	D8/1
6,233,868	B1	*	5/2001	Hahn et al.	.....	47/30
7,185,666	B2	*	3/2007	Chai	.....	135/135
7,497,048	B2		3/2009	Bakowski		

\* cited by examiner

*Primary Examiner* — Holly Baynham

*Assistant Examiner* — Sheryl Lane

(74) *Attorney, Agent, or Firm* — Tarolli, Sundheim, Covell & Tummino LLP

(57) **CLAIM**

The ornamental design for an shrub cover, as shown and described.

**DESCRIPTION**

FIG. 1 is a top perspective view of a shrub cover showing our new design;

FIG. 2 is a bottom perspective view thereof;

FIG. 3 is a front side elevation view thereof, the rear side elevation view being a mirror image;

FIG. 4 is a left side elevation view thereof, the right side elevation view being a mirror image;

FIG. 5 is a top view thereof;

FIG. 6 is a bottom or inside view thereof;

FIG. 7 is a perspective view of the shrub cover, shown with parts separated for ease of disclosure;

FIG. 8 is a front elevation view of the shrub cover, shown in a collapsed position;

FIG. 9 is a side elevation view of the shrub cover, shown in a collapsed position; and,

FIG. 10 is a perspective view of FIG. 1 further illustrating the surface texture of the material forming the outer surface of the shrub cover.

Broken lines are shown for environmental purposes and form no part of the claimed design.

The dashed lines in FIG. 5 on the surface of the shrub cover opposite the rods are impressions and are part of the claimed design.

**1 Claim, 7 Drawing Sheets**

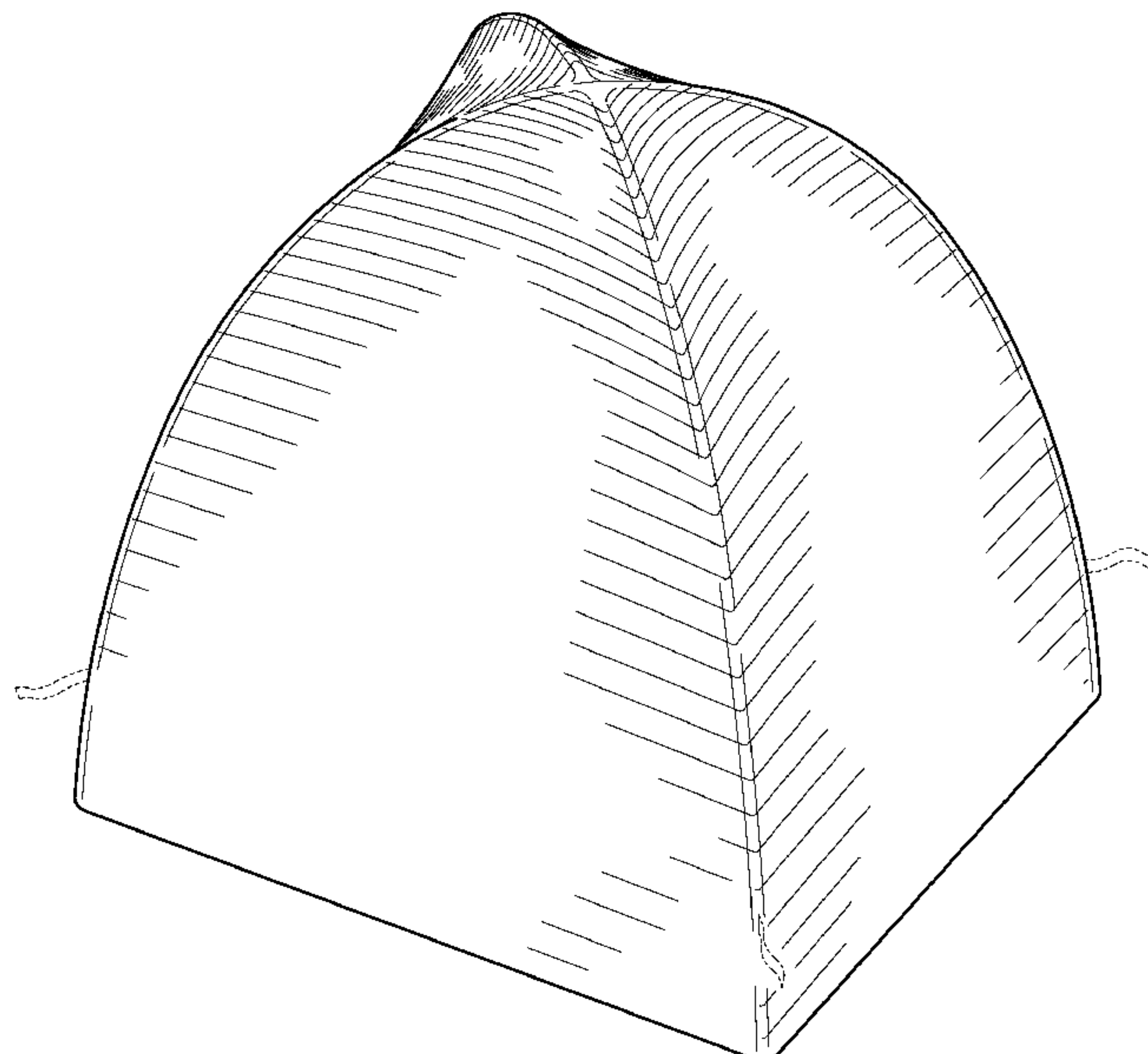

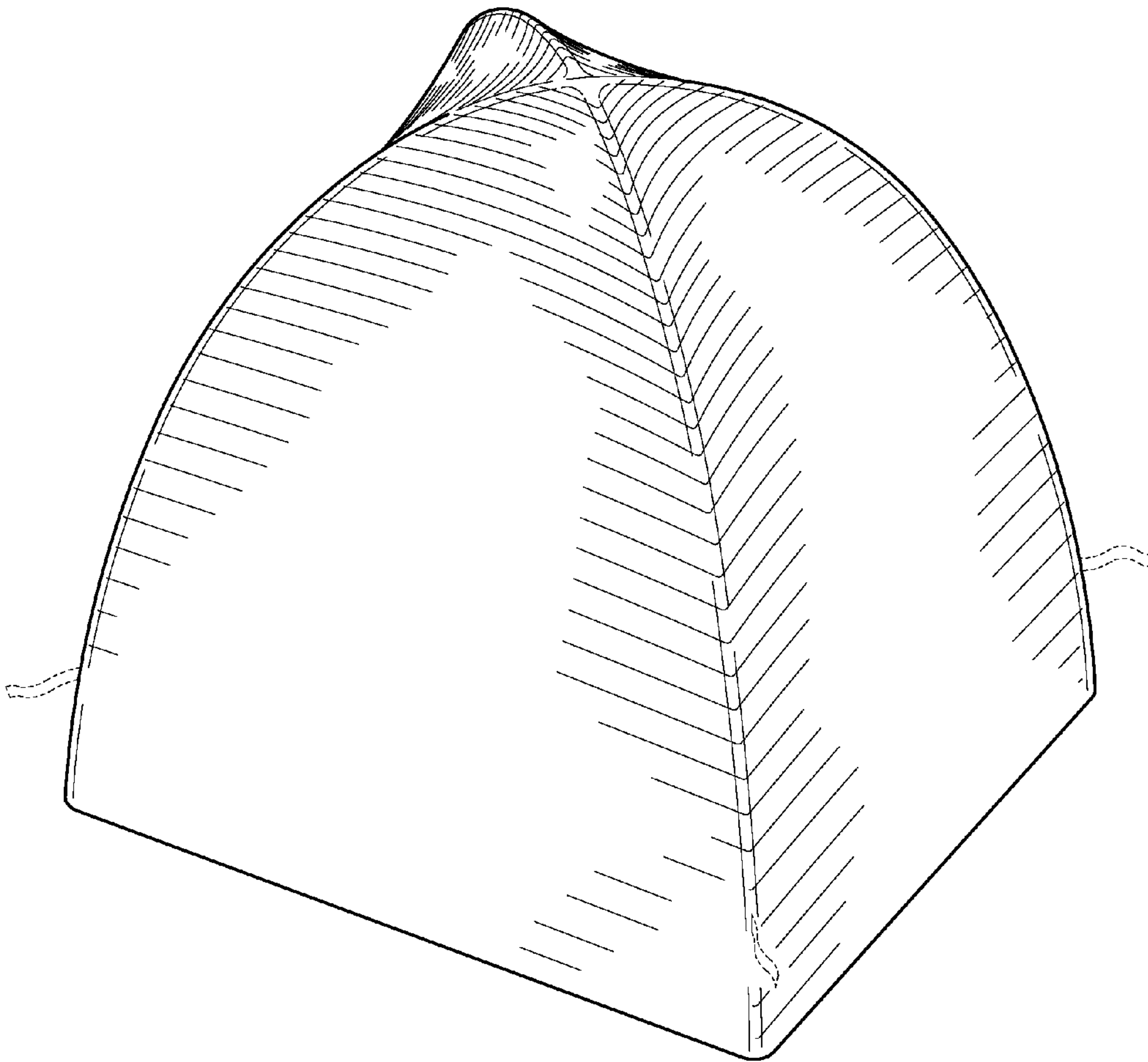

Fig. 1

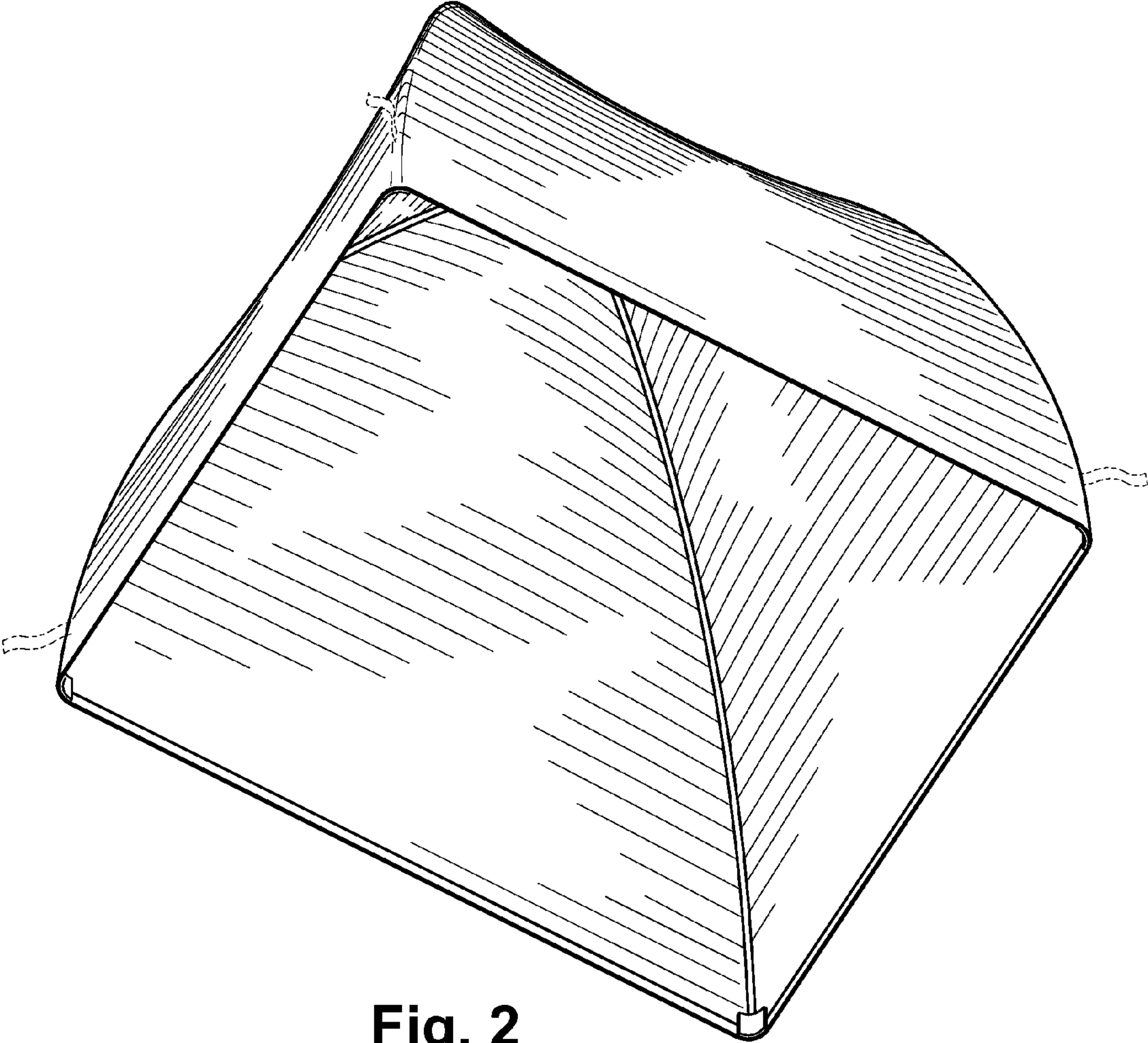

Fig. 2

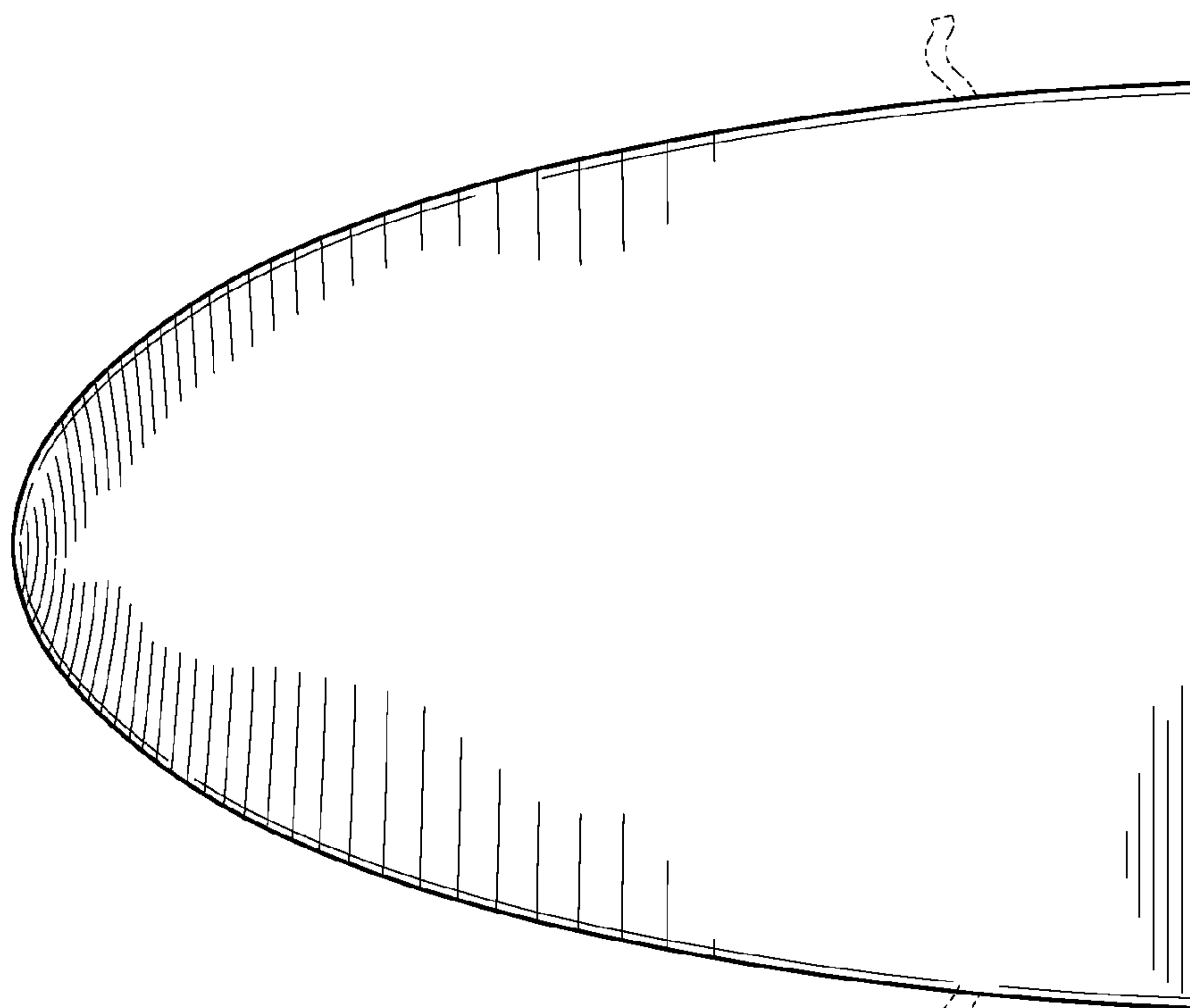

Fig. 4

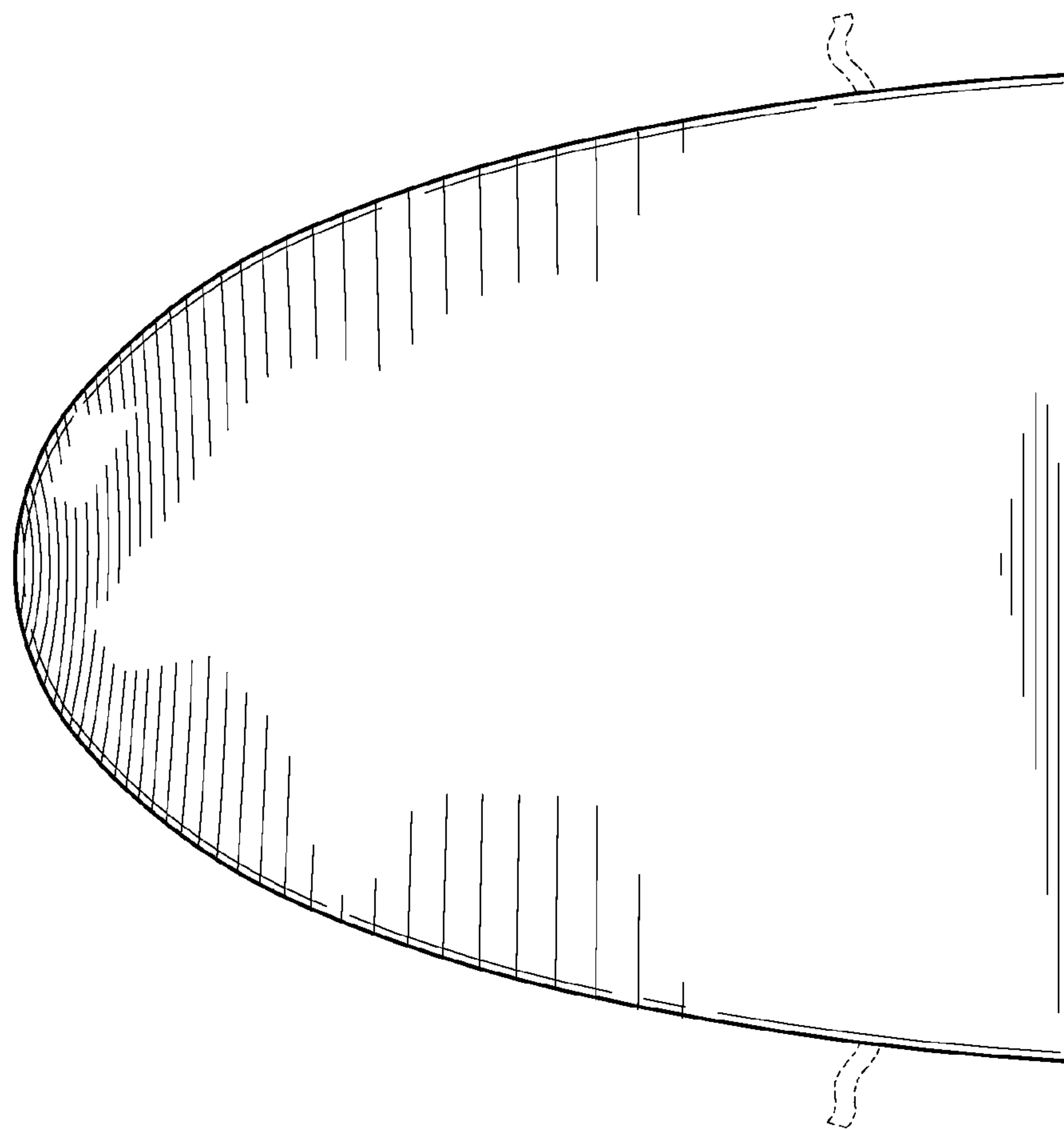

Fig. 3



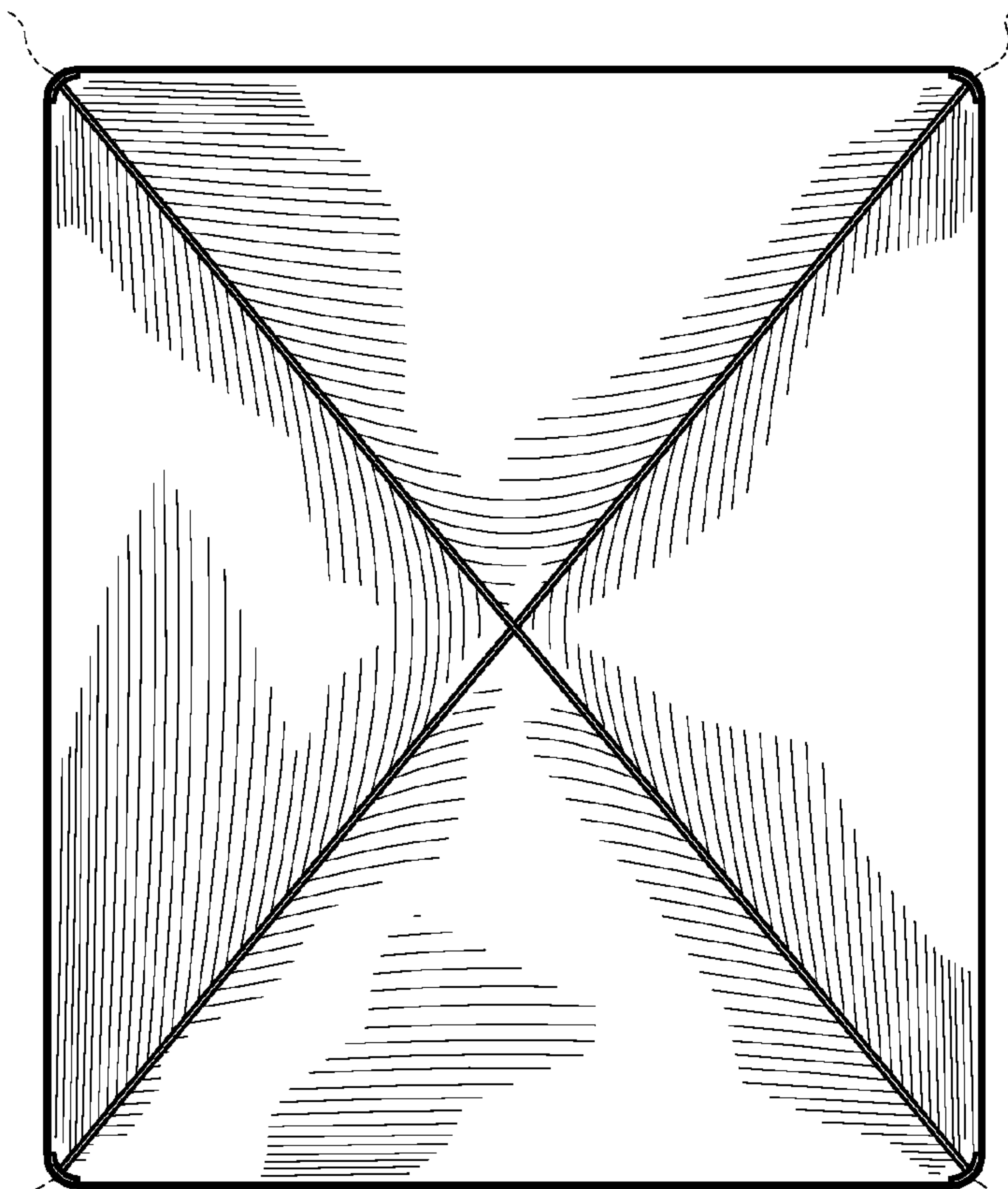

Fig. 6

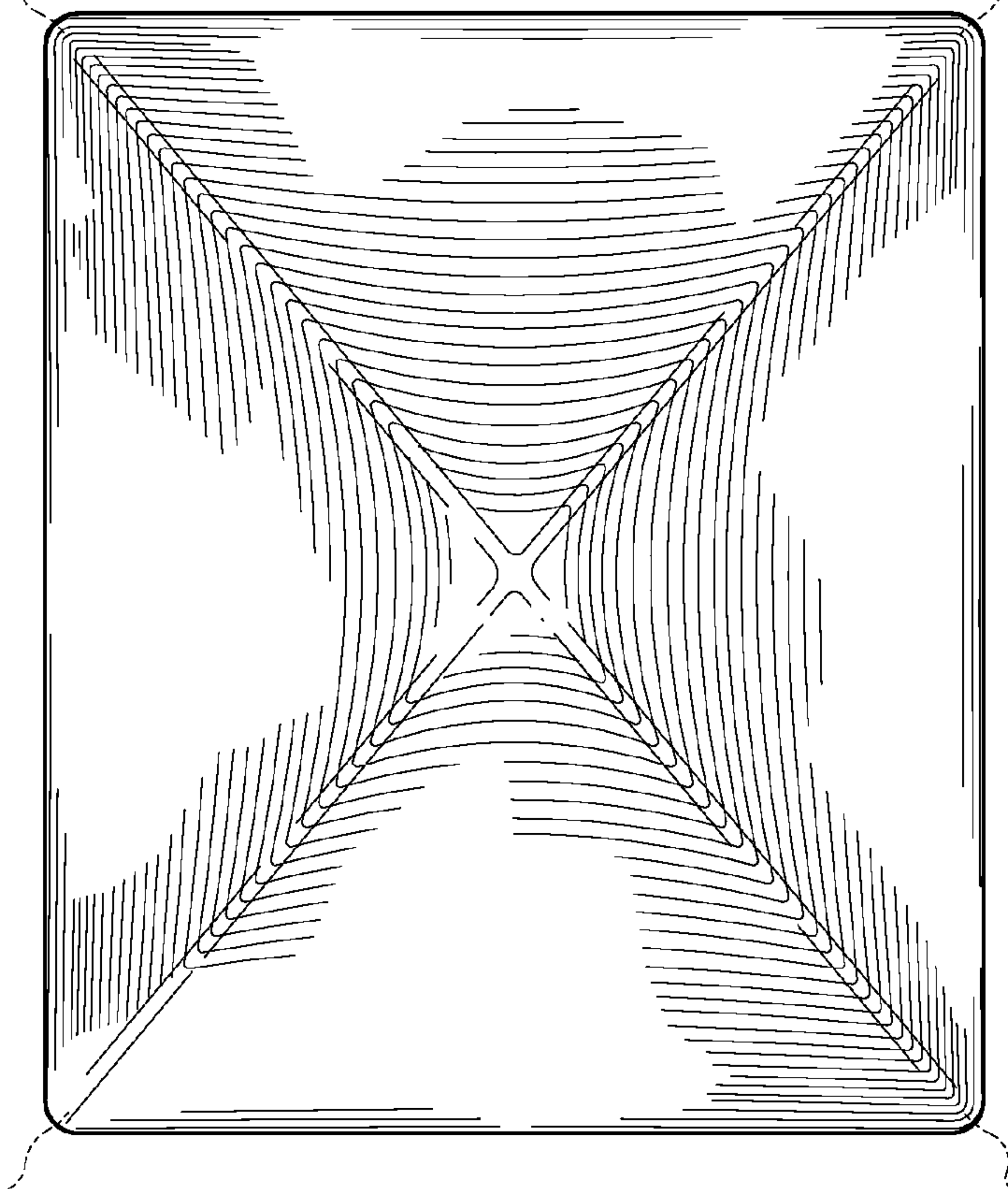

Fig. 5

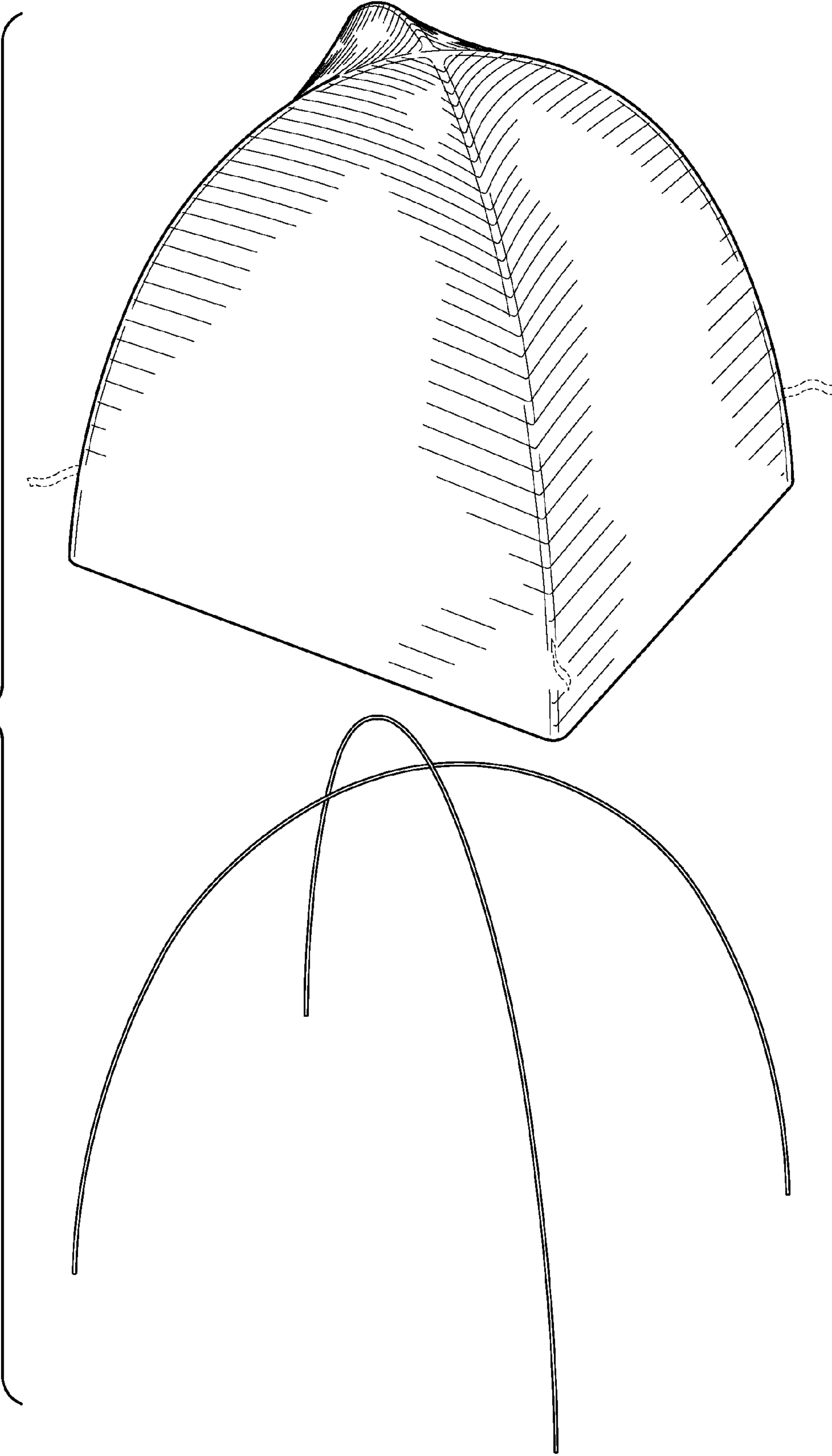

Fig. 7



Fig. 9

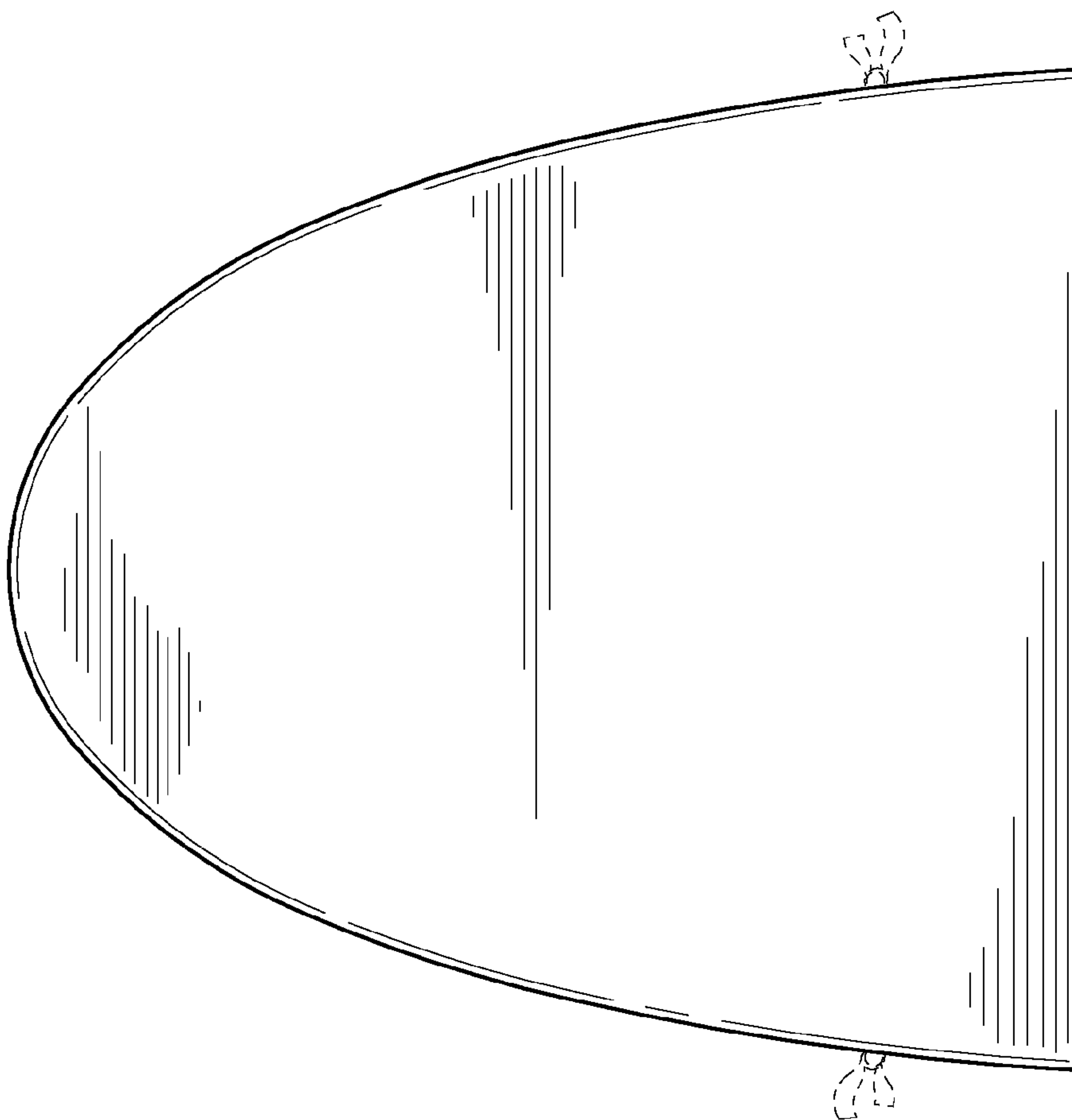

Fig. 8

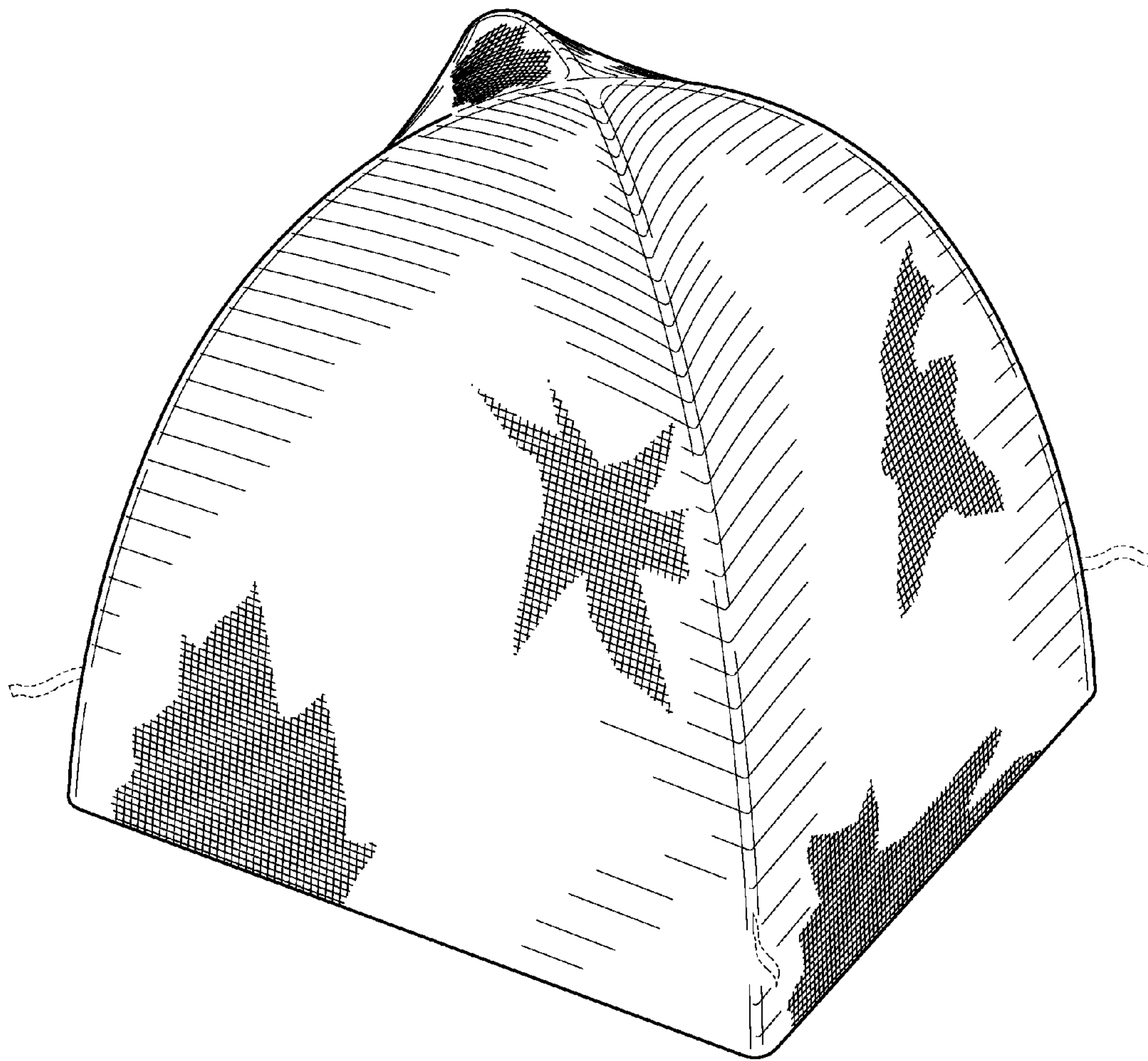

Fig. 10