



US00D653910S

(12) **United States Design Patent**
Stamper et al.

(10) **Patent No.:** **US D653,910 S**

(45) **Date of Patent:** **** Feb. 14, 2012**

(54) **ROUND BOWL**

(75) Inventors: **Leonard R. Stamper**, Anaheim Hills,
CA (US); **Brian Sykes**, Mission Viejo,
CA (US)

(73) Assignee: **Shye Worldwide, LLC, (CA Ltd**
Liability Co.), Tustin, CA (US)

(**) Term: **14 Years**

(21) Appl. No.: **29/396,980**

(22) Filed: **Jul. 9, 2011**

(51) **LOC (9) Cl.** **07-01**

(52) **U.S. Cl.** **D7/543**

(58) **Field of Classification Search** D7/545,
D7/586, 500, 543, 566, 620, 629, 552.1, 354,
D7/584, 360, 361; 220/751, 23.4, 574; D9/432;
D30/127

See application file for complete search history.

(56) **References Cited**

U.S. PATENT DOCUMENTS

D207,594 S *	5/1967	Aubecq	D7/542
D235,497 S *	6/1975	Cyren	D7/360
D255,079 S *	5/1980	Gobleck, Jr.	D7/539
D268,557 S *	4/1983	Jensen et al.	D7/545
D288,050 S *	2/1987	Fox et al.	D7/545
D296,640 S *	7/1988	Miller	D7/545

D338,807 S *	8/1993	Conti	D7/545
D432,360 S *	10/2000	Greene	D7/543
D452,417 S *	12/2001	Whitmore et al.	D7/543
D456,673 S *	5/2002	Kerman	D7/545
D459,635 S *	7/2002	Henry	D7/545
D483,218 S *	12/2003	Fino et al.	D7/360
D483,617 S *	12/2003	Watson	D7/545
D582,218 S *	12/2008	Curtin	D7/629
D604,989 S *	12/2009	Chen et al.	D7/360
D607,280 S *	1/2010	Kellermann et al.	D7/548
D608,149 S *	1/2010	Kellermann et al.	D7/548

* cited by examiner

Primary Examiner — Cynthia Underwood

(74) *Attorney, Agent, or Firm* — Curtis L. Harrington;
Harrington & Harrington

(57) **CLAIM**

The ornamental design for a round bowl, as shown and described.

DESCRIPTION

FIG. 1 is a perspective view of a round bowl;

FIG. 2 is a front view,

FIG. 3 is a rear view,

FIG. 4 is a left side view;

FIG. 5 is a right side view;

FIG. 6 is a top view; and,

FIG. 7 is a bottom view.

The broken lines represent a portion of the structure that forms no part of the claim.

1 Claim, 3 Drawing Sheets

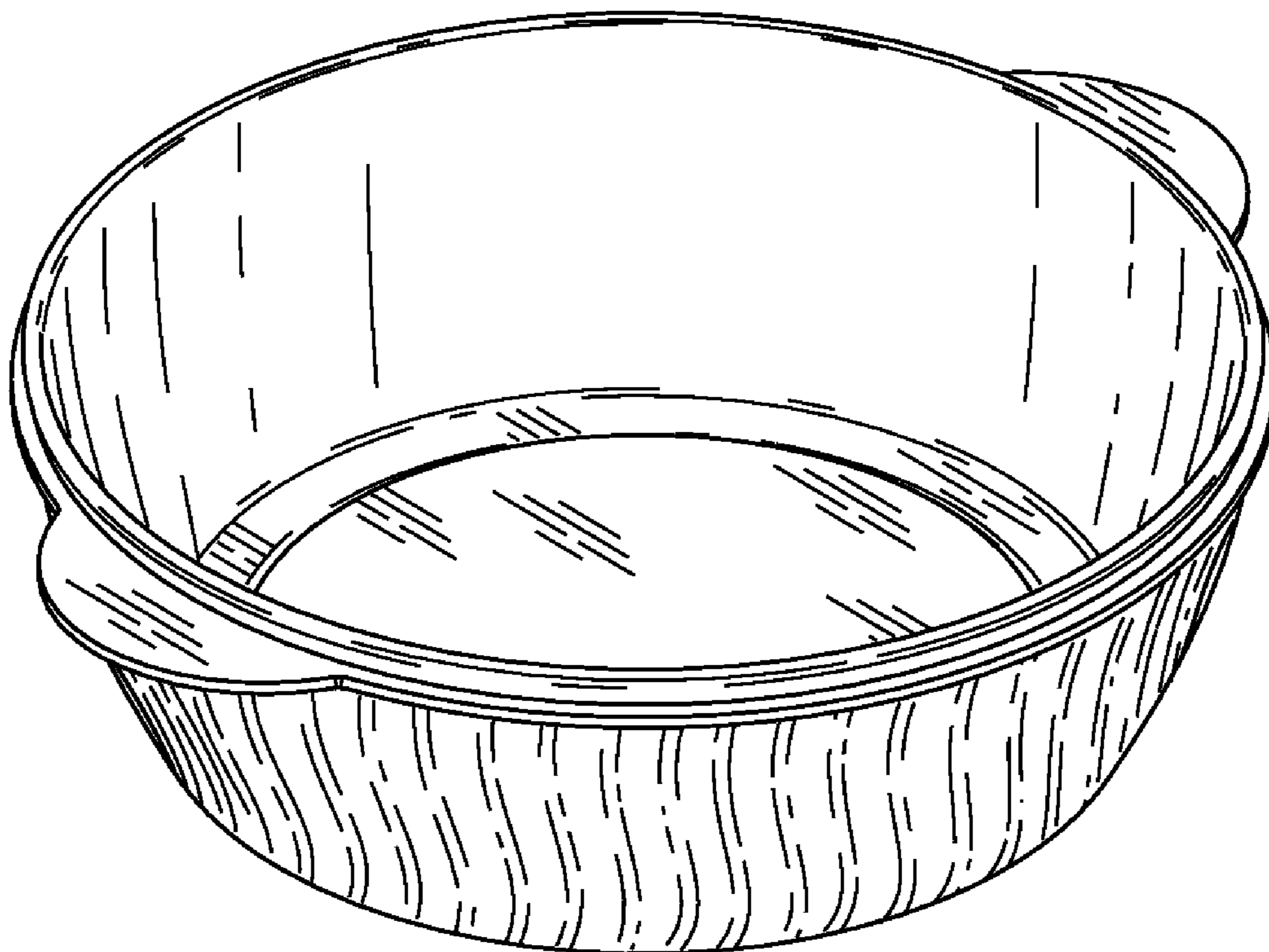

Fig. 1

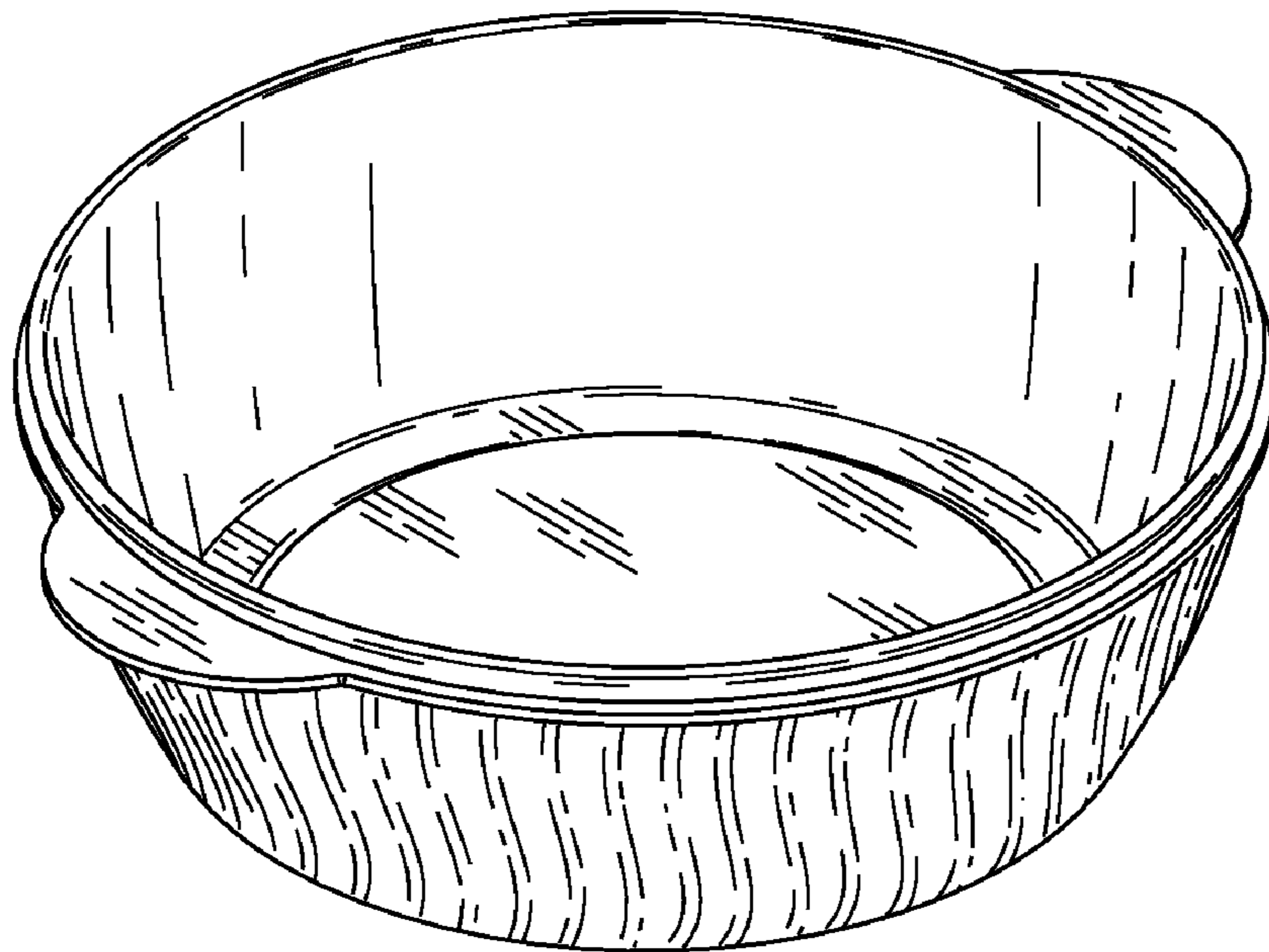

Fig. 2

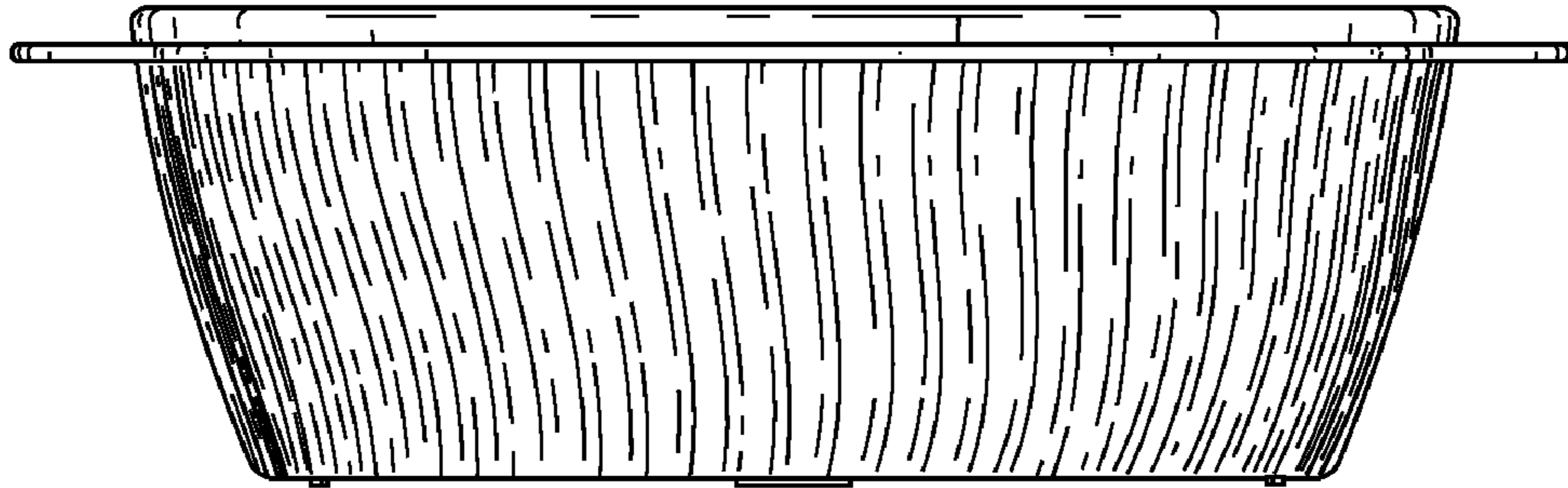

Fig. 3

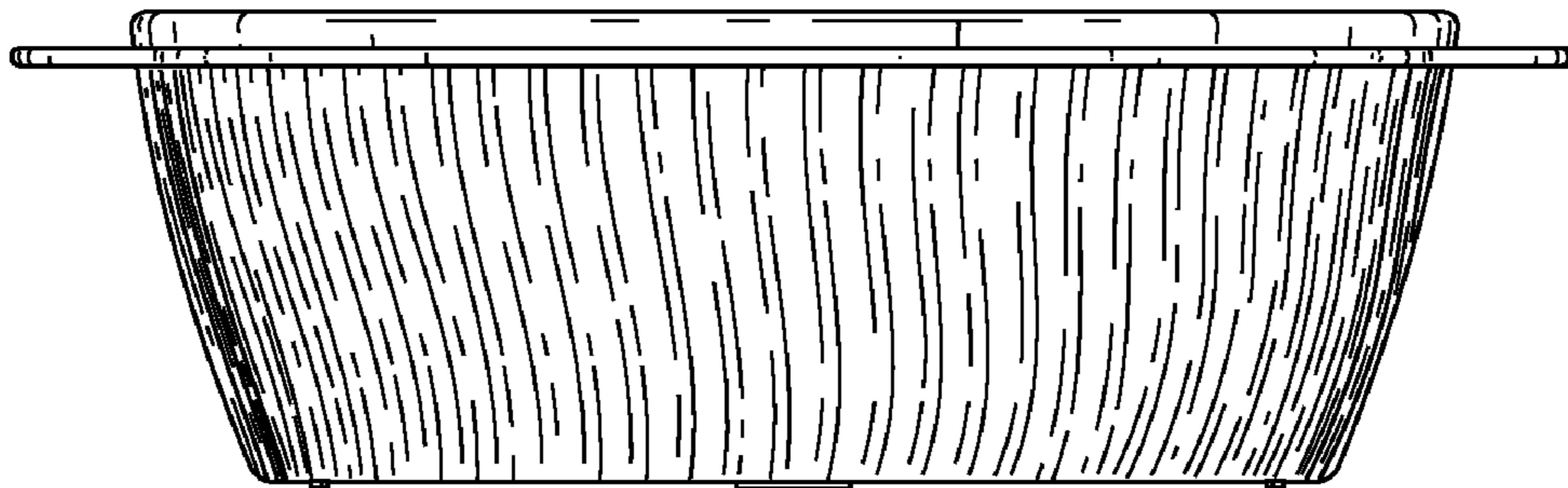

Fig. 4

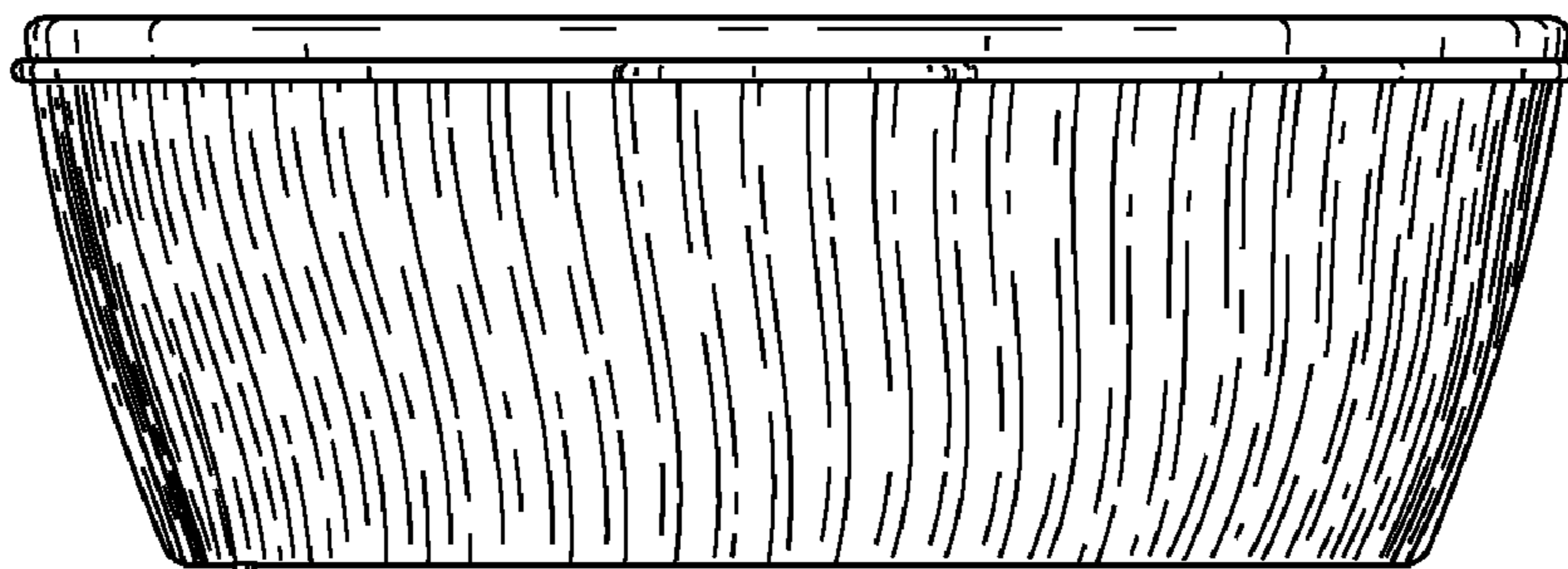

Fig. 5

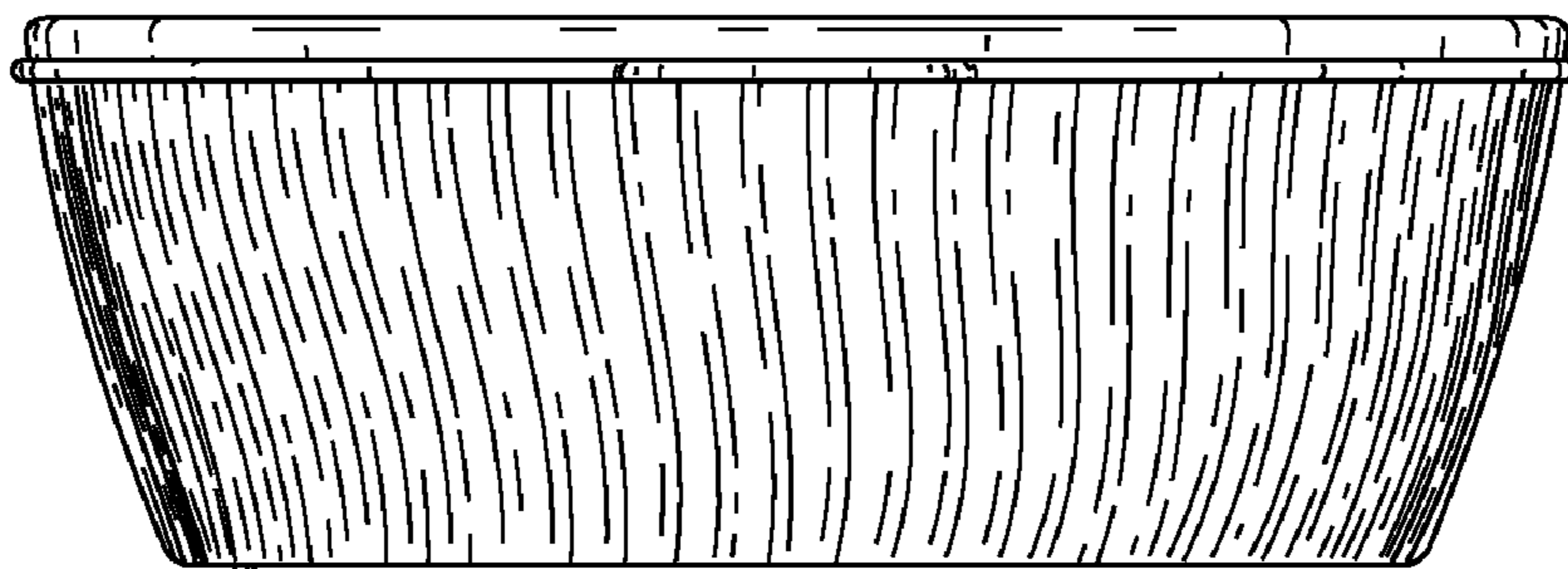

Fig. 6

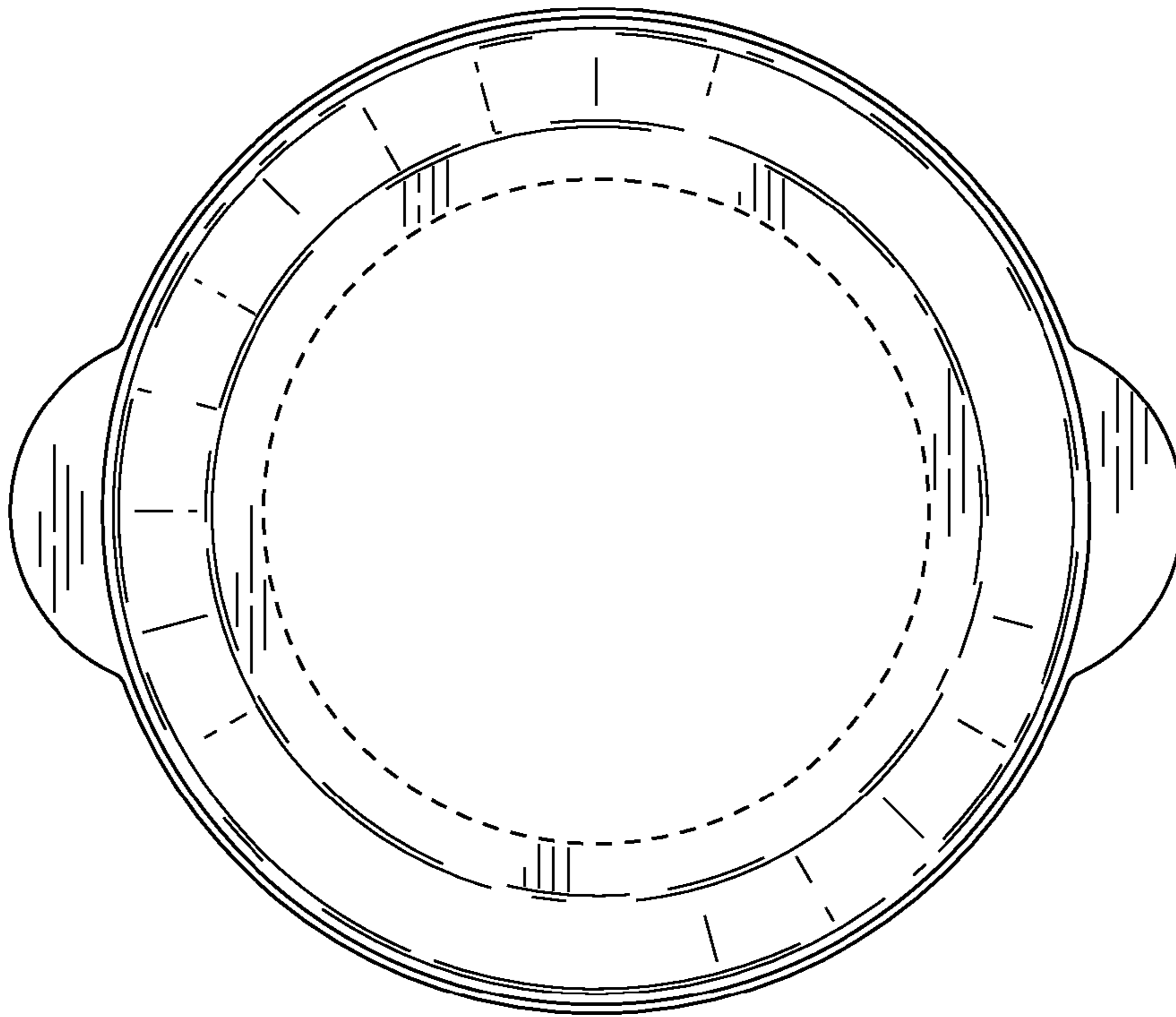

Fig. 7

