



US00D653853S

(12) **United States Design Patent**
Ryan et al.

(10) **Patent No.:** **US D653,853 S**

(45) **Date of Patent:** **** *Feb. 14, 2012**

(54) **RACQUET EQUIPMENT BAG**

(75) Inventors: **Christopher W. Ryan**, Bartlett, IL (US);
Saud Khazal, Milwaukee, WI (US)

(73) Assignee: **Wilson Sporting Goods Co.**, Chicago,
IL (US)

(*) Notice: This patent is subject to a terminal disclaimer.

(**) Term: **14 Years**

(21) Appl. No.: **29/341,705**

(22) Filed: **Aug. 11, 2009**

(51) **LOC (9) Cl.** **03-01**

(52) **U.S. Cl.** **D3/256**

(58) **Field of Classification Search** D3/256,
D3/217, 221, 254, 289, 233, 287, 273; 206/315.1,
206/315.9; 190/103, 100, 126, 127, 115;
150/117, 163

See application file for complete search history.

(56) **References Cited**

U.S. PATENT DOCUMENTS

1,976,698	A *	10/1934	Gihon	190/102
D238,011	S *	12/1975	Canton	D3/256
D245,456	S *	8/1977	Barrett	D3/256
D255,508	S *	6/1980	Hughes	D3/256
D279,046	S *	6/1985	Soininen	D3/256
D280,359	S *	9/1985	Bohunsky	D3/204
D281,290	S *	11/1985	Beigel	D3/256
D320,692	S *	10/1991	Killer	D3/256
D363,599	S *	10/1995	Gaffin	D3/246
D367,034	S *	2/1996	Berman	D12/409
D375,660	S *	11/1996	Parris	D7/628
D425,698	S *	5/2000	Paul et al.	D3/217
6,138,881	A *	10/2000	Paul et al.	224/153
D446,013	S *	8/2001	Pironti	D3/287
6,588,789	B1 *	7/2003	Porcella	280/290
6,595,358	B1 *	7/2003	Speck	206/315.9

D480,869	S *	10/2003	Mello	D3/228
D482,518	S *	11/2003	Nakajima	D3/204
D496,159	S *	9/2004	Foster	D3/256
D501,994	S *	2/2005	Tauchen	D3/256
D572,477	S *	7/2008	Young	D3/271.11
7,395,930	B2 *	7/2008	Tauchen	206/579

* cited by examiner

Primary Examiner — John Windmuller

(74) *Attorney, Agent, or Firm* — Terence P. O'Brien

(57) **CLAIM**

We claim the ornamental design for a racquet equipment bag, as shown and described.

DESCRIPTION

FIG. 1 is a top, side perspective view of a racquet equipment bag;

FIG. 2 is a top, second end perspective view of the racquet equipment bag of FIG. 1;

FIG. 3 is a first side view of the racquet equipment bag of FIG. 1;

FIG. 4 is a second side view of the racquet equipment bag of FIG. 1;

FIG. 5 is a first end view of the racquet equipment bag of FIG. 1;

FIG. 6 is a second end view of the racquet equipment bag of FIG. 1;

FIG. 7 is a top view of the racquet equipment bag of FIG. 1; and,

FIG. 8 is a bottom view of the racquet equipment bag of FIG. 1.

The ornamental design that is claimed is shown in solid lines in the drawings. The broken (dashed) lines shown in FIGS. 1 through 8 are included for the purpose of illustrating environmental elements only and form no part of the claimed design. The broken (dashed) lines shown in FIGS. 1 through 8 are not intended to illustrate or represent stitching or any other non-environmental elements.

1 Claim, 4 Drawing Sheets

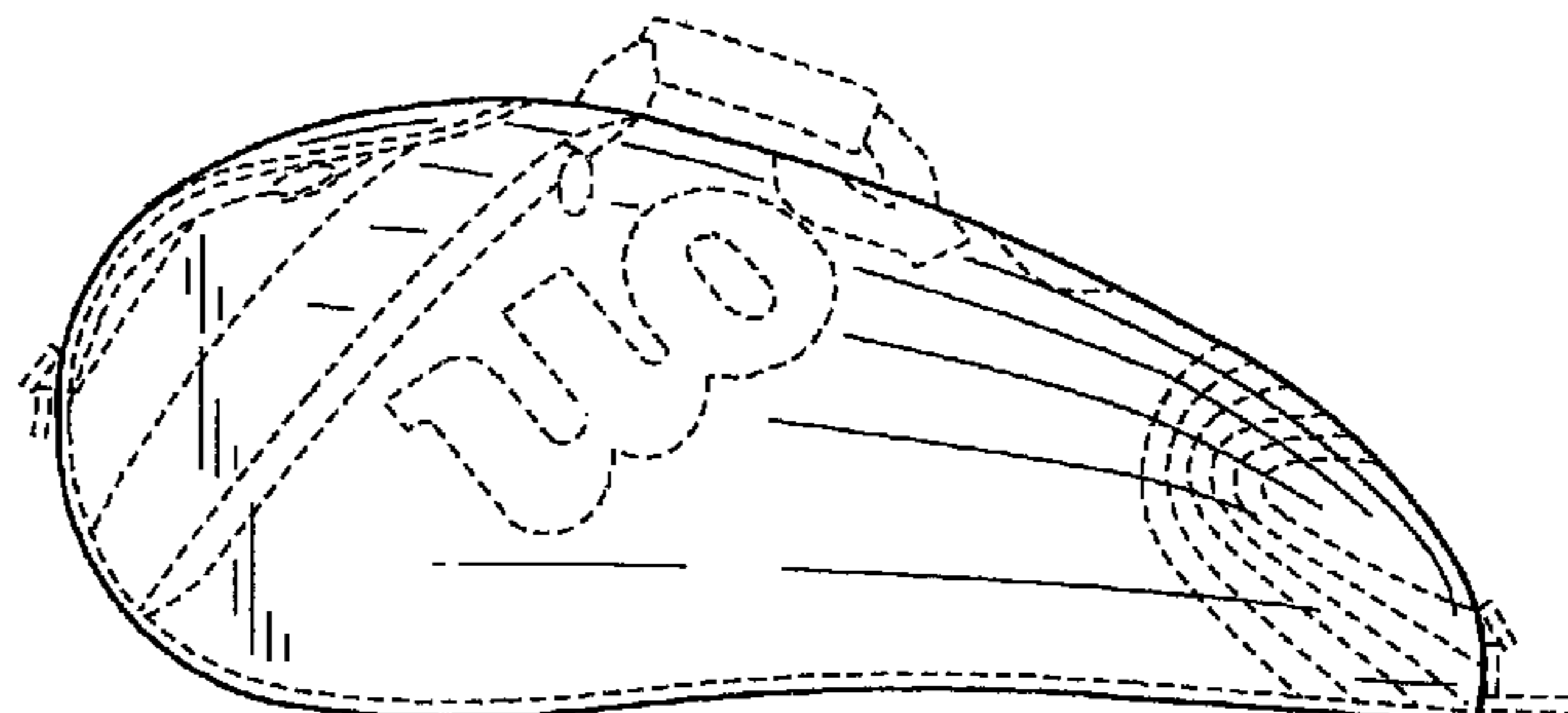
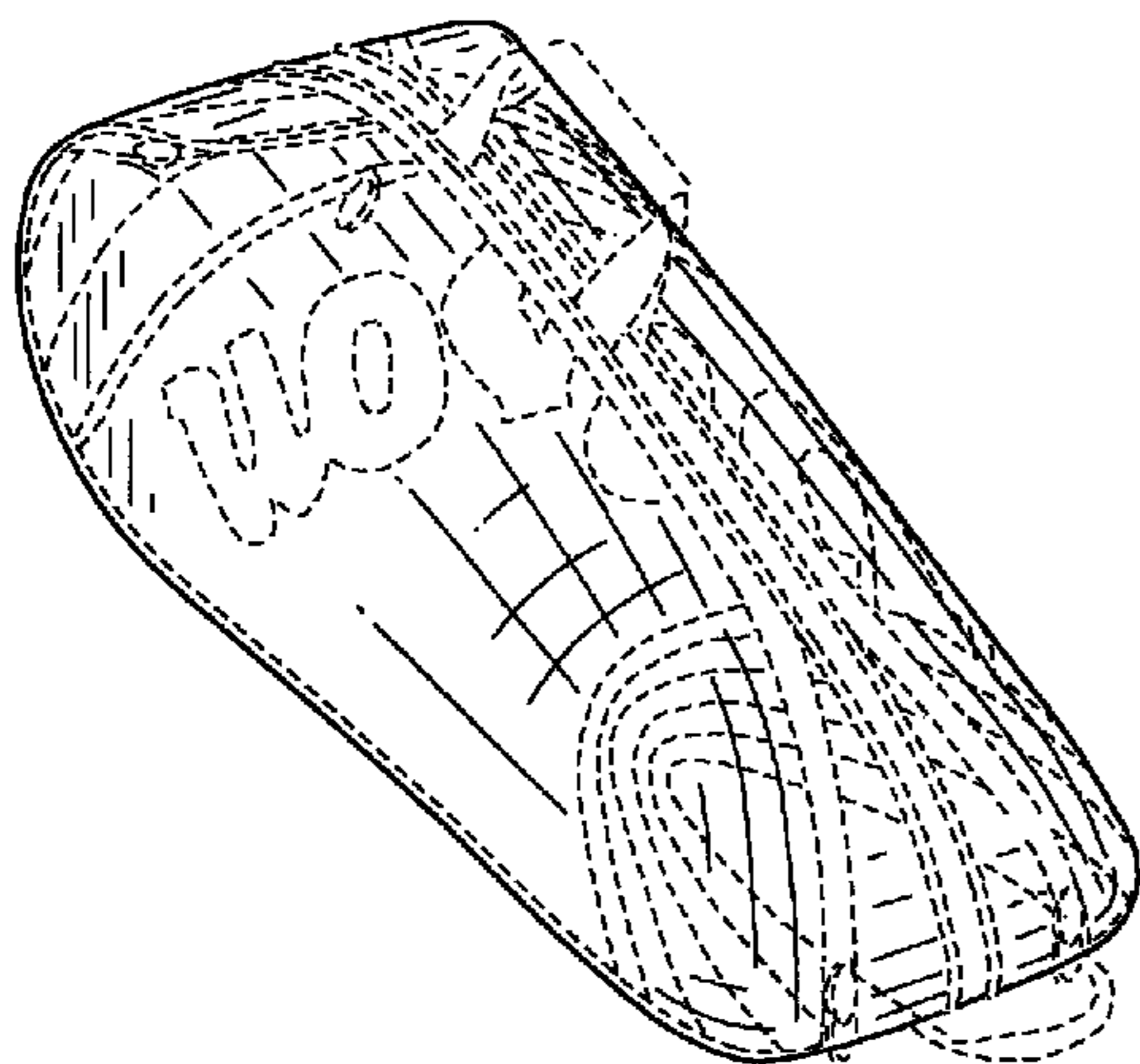

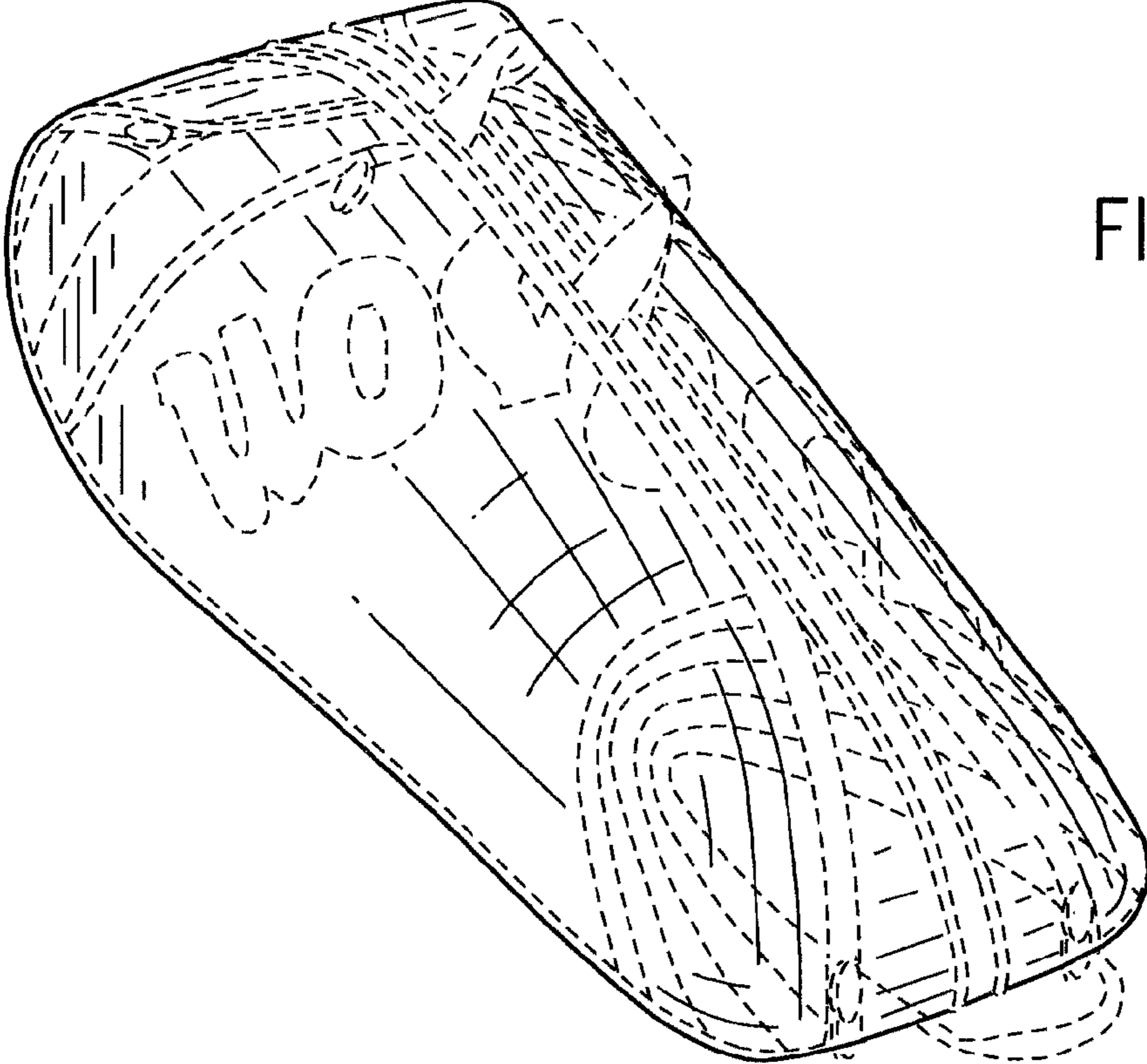

FIG. 1

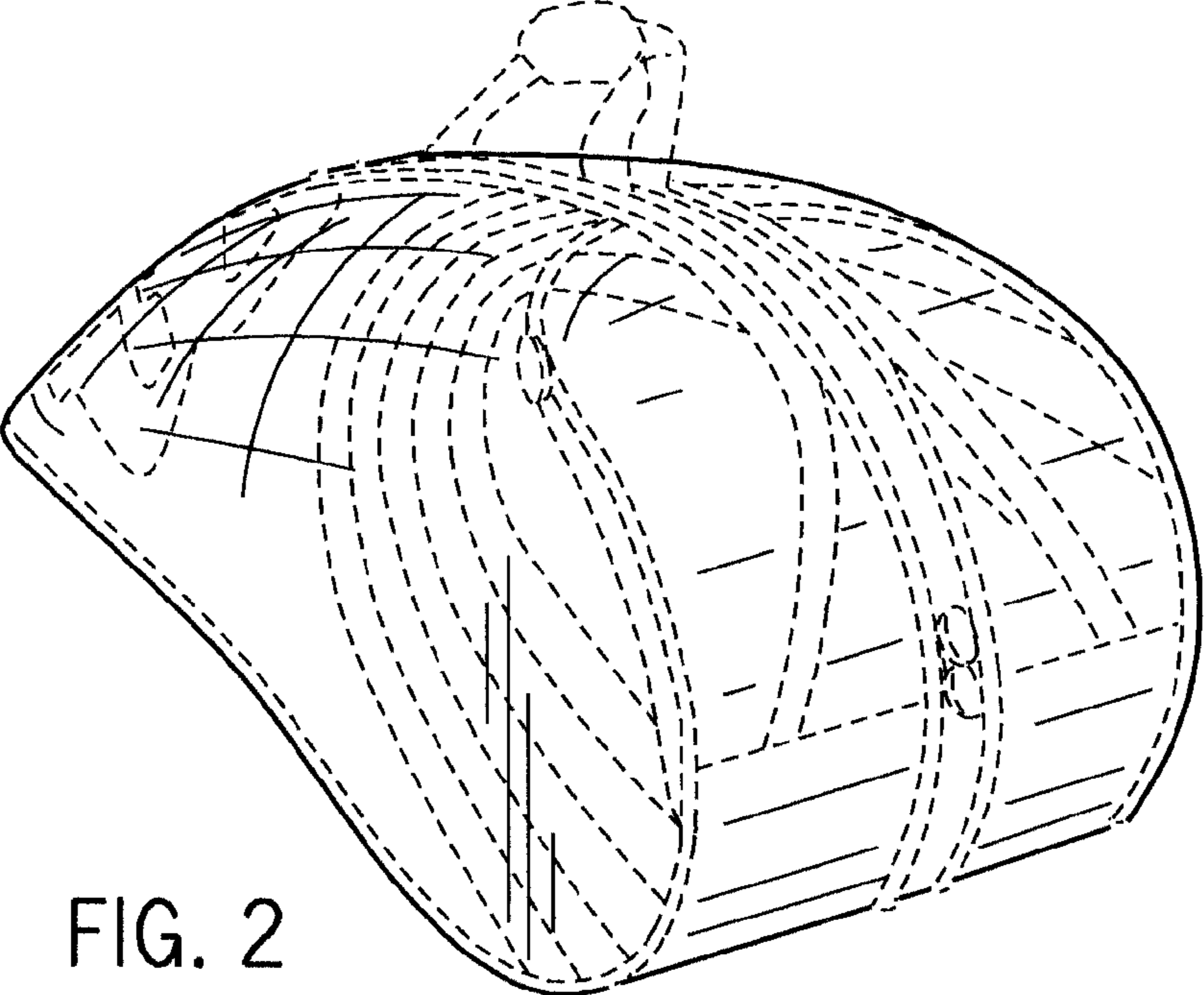

FIG. 2

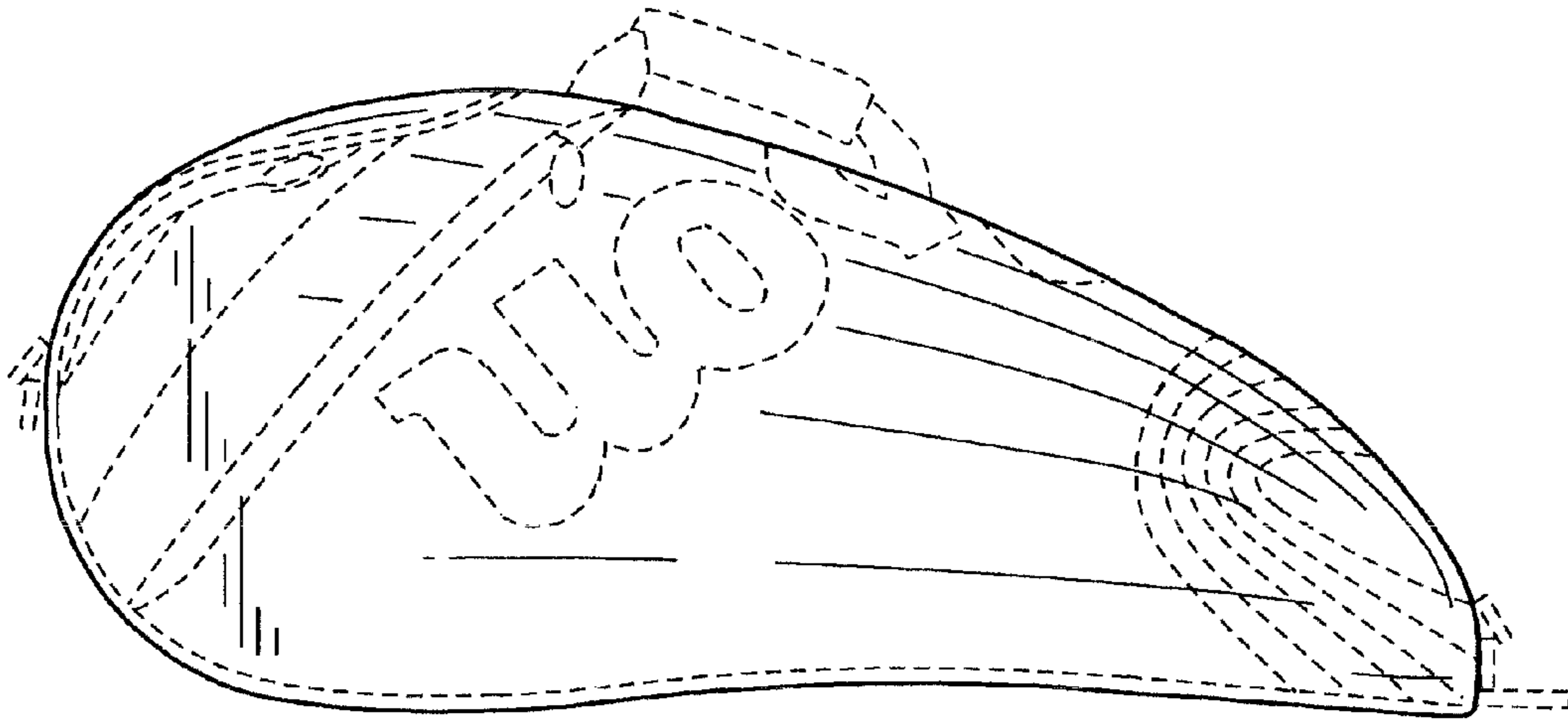

FIG. 3

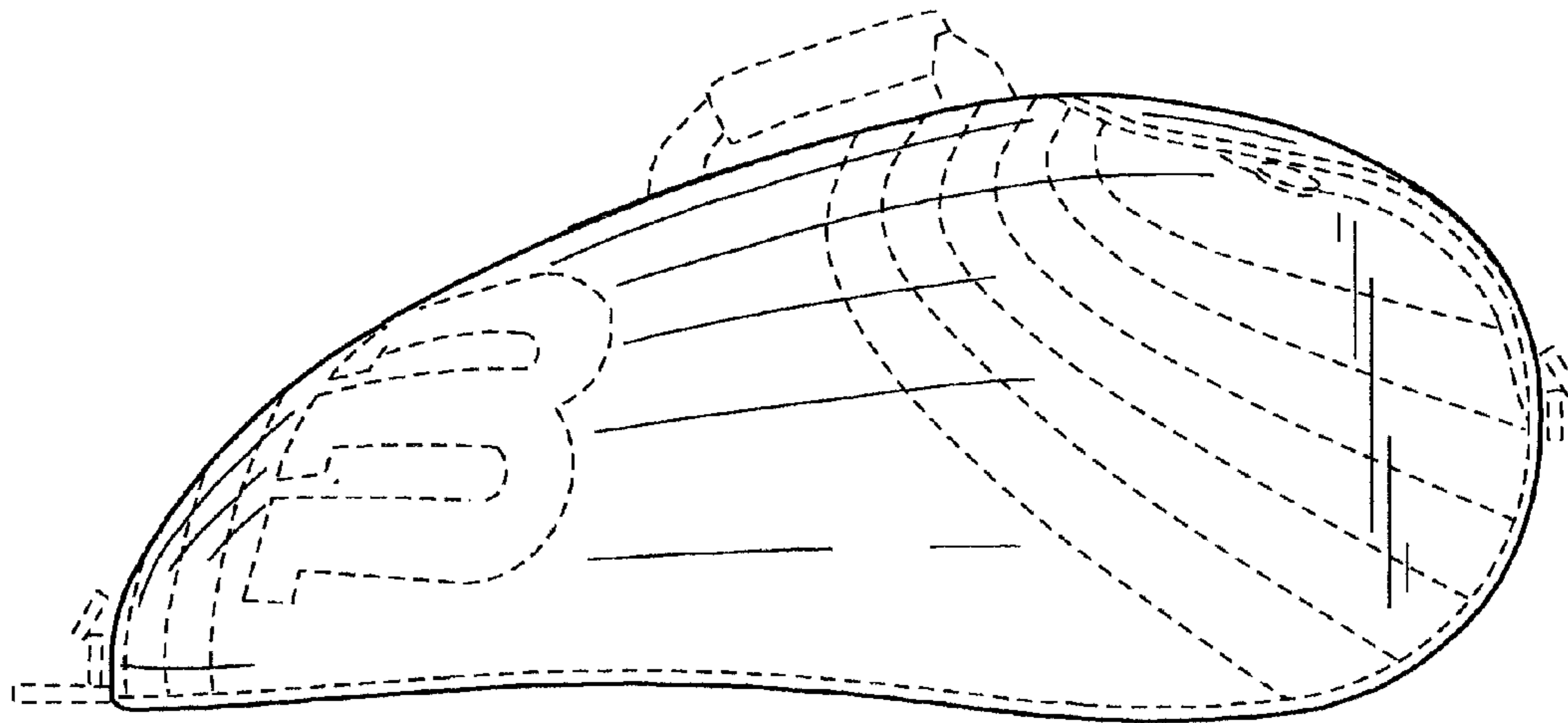

FIG. 4

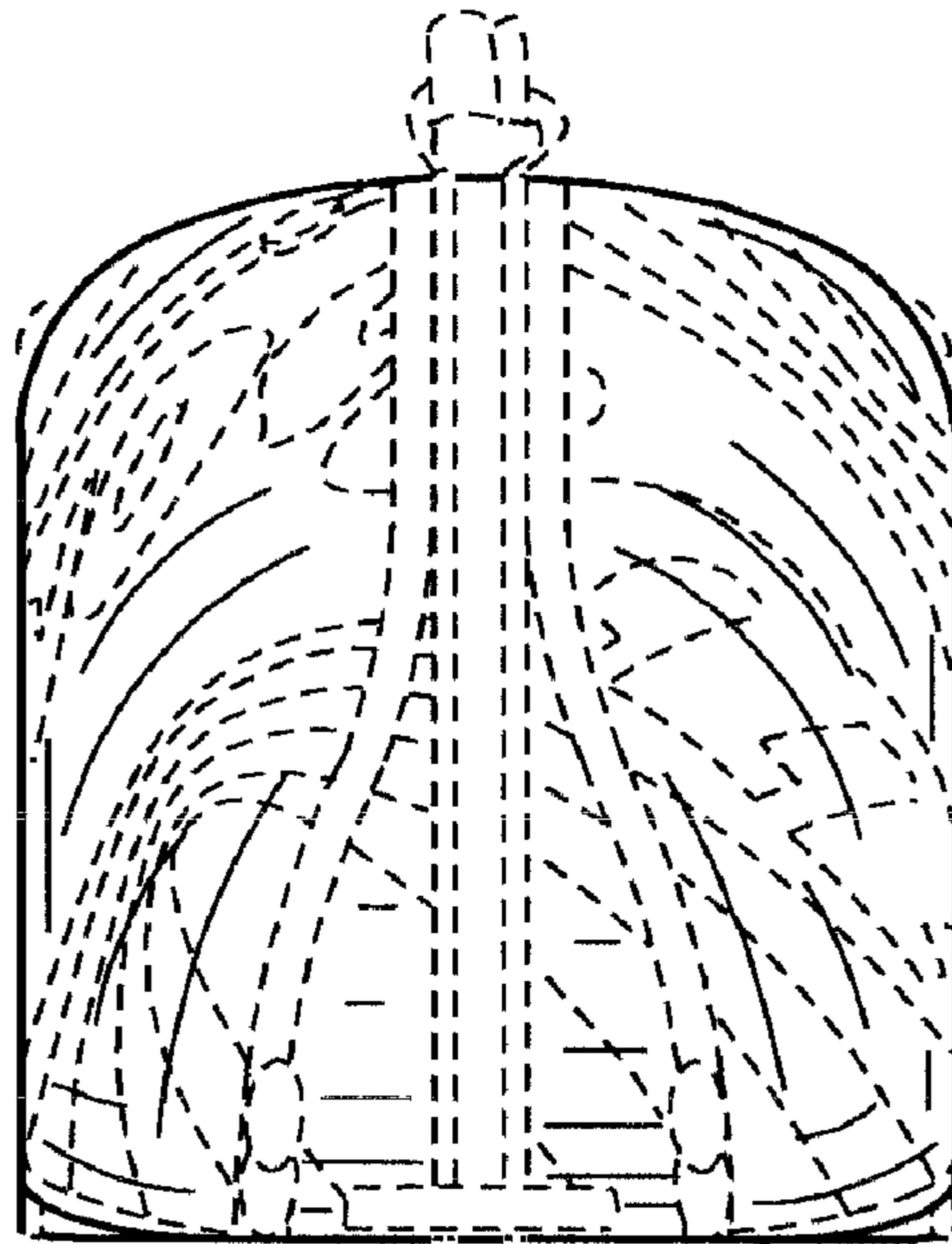

FIG. 5

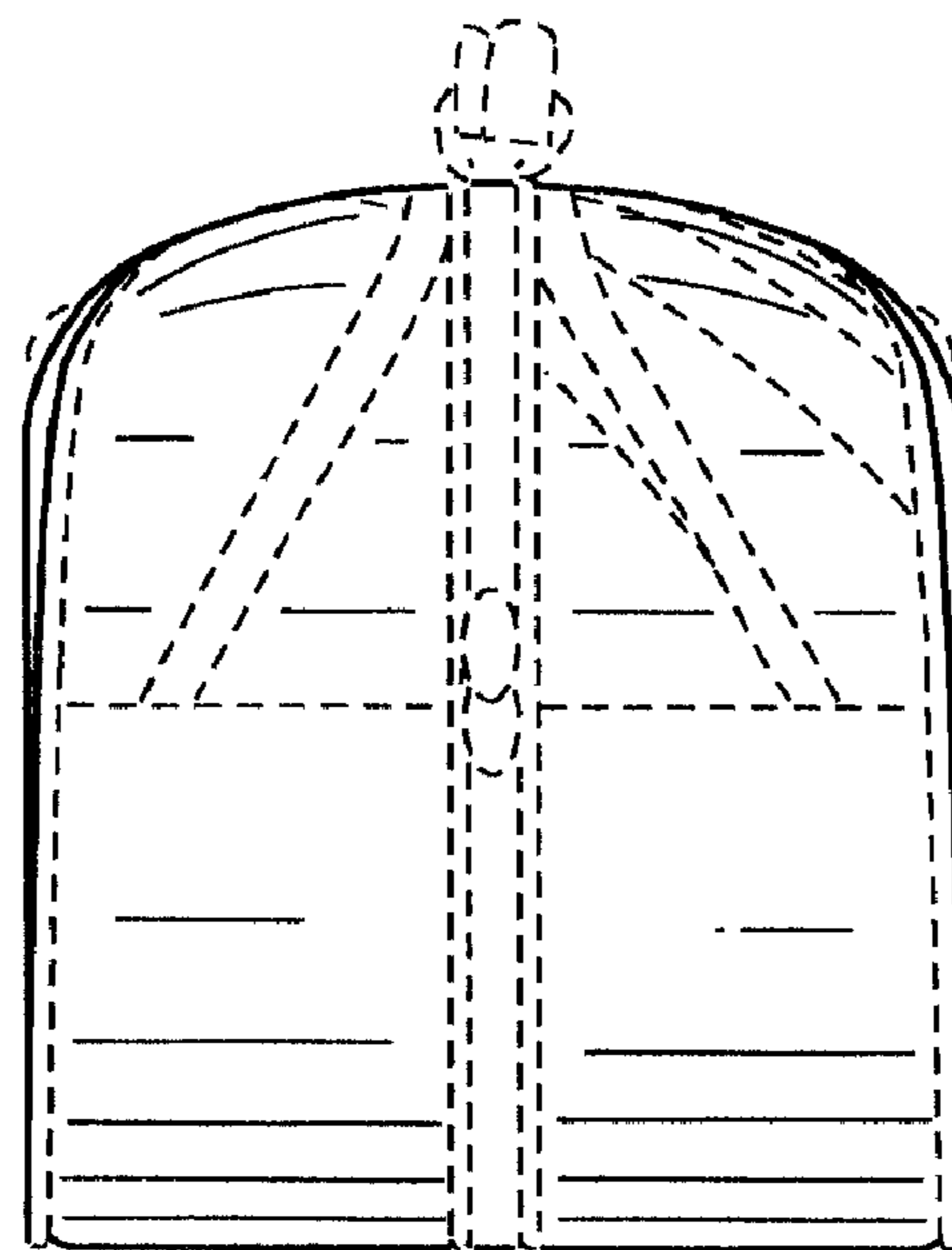

FIG. 6

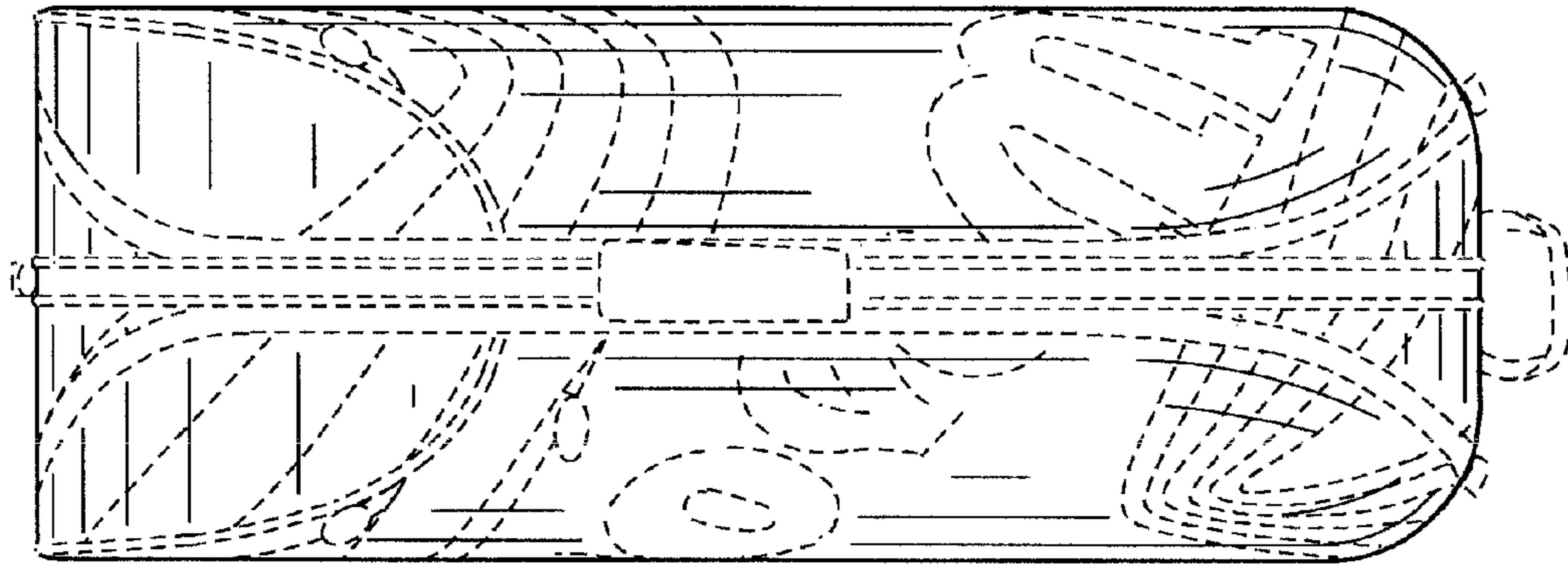

FIG. 7

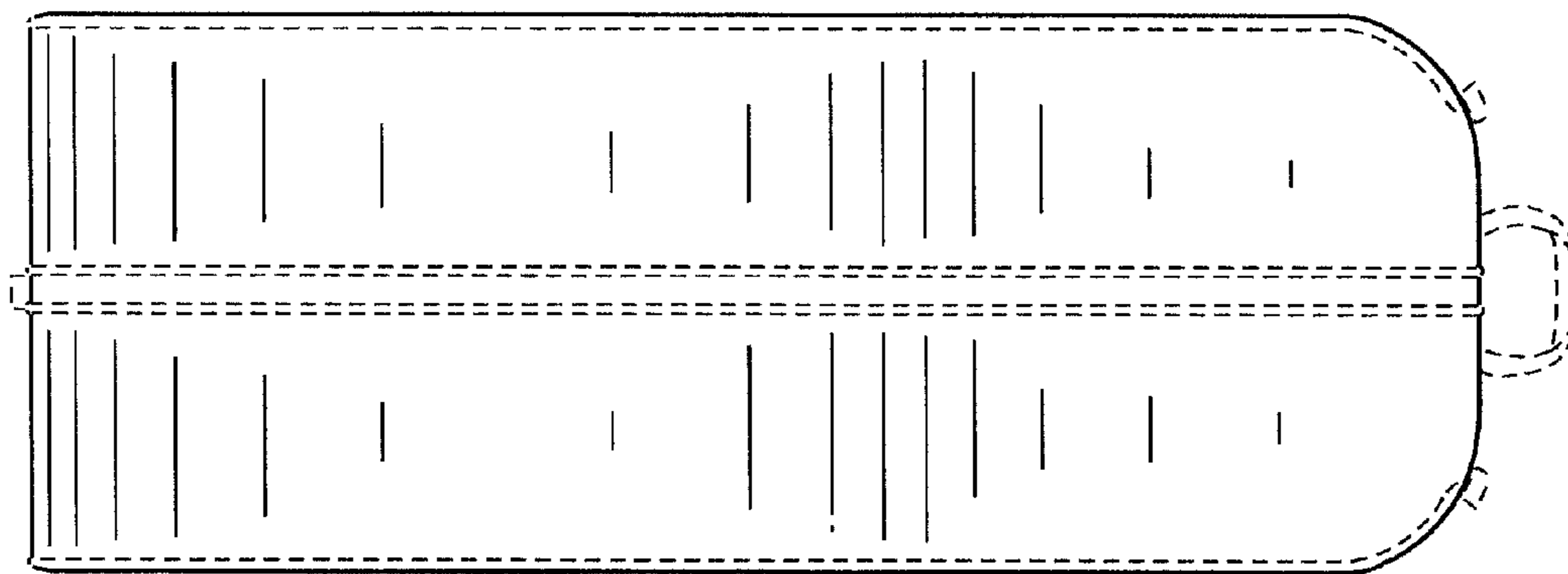

FIG. 8