



US00D653828S

(12) **United States Design Patent**
Seehoff et al.

(10) **Patent No.:** **US D653,828 S**

(45) **Date of Patent:** **** Feb. 7, 2012**

(54) **SPONGE HOLDER**

(75) Inventors: **Gary Stanley Seehoff**, Encino, CA
(US); **Christopher Anzalone**, Foothill
Ranch, CA (US)

(73) Assignee: **Evrholder Products, LLC**, Anaheim,
CA (US)

(**) Term: **14 Years**

(21) Appl. No.: **29/365,996**

(22) Filed: **Jul. 17, 2010**

(51) **LOC (9) Cl.** **32-01**

(52) **U.S. Cl.** **D32/52**

(58) **Field of Classification Search** D6/524;
D32/35, 40, 52; 15/229.13; 294/93, 99.2
See application file for complete search history.

(56) **References Cited**

U.S. PATENT DOCUMENTS

2,012,500	A *	8/1935	Ebert et al.	15/229.13
D152,048	S *	12/1948	Weiss	D32/52
2,518,873	A *	8/1950	Eisenberg et al.	15/143.1
D297,873	S *	9/1988	Silver	D32/52

D393,508	S *	4/1998	Rademacher	D32/52
6,761,386	B2 *	7/2004	Mandle et al.	294/99.2
D522,202	S *	5/2006	Huang	D32/52
D547,954	S *	8/2007	Thurin et al.	D32/52
D554,311	S *	10/2007	Lee et al.	D32/52
D554,315	S *	10/2007	Schouten	D32/52

* cited by examiner

Primary Examiner — Brian N Vinson

(57) **CLAIM**

The ornamental design for a sponge holder, as shown and described.

DESCRIPTION

FIG. 1 is a top plan view of a sponge holder showing our new design;
FIG. 2 is a front elevational view thereof;
FIG. 3 is a left-side elevational view thereof;
FIG. 4 is a right-side elevational view thereof;
FIG. 5 is a rear elevational view thereof;
FIG. 6 is a bottom plan view thereof;
FIG. 7 is a vertical cross-sectional perspective view thereof, taken in the direction of line 7-7 of FIG. 1; and,
FIG. 8 is a perspective view thereof.

1 Claim, 8 Drawing Sheets

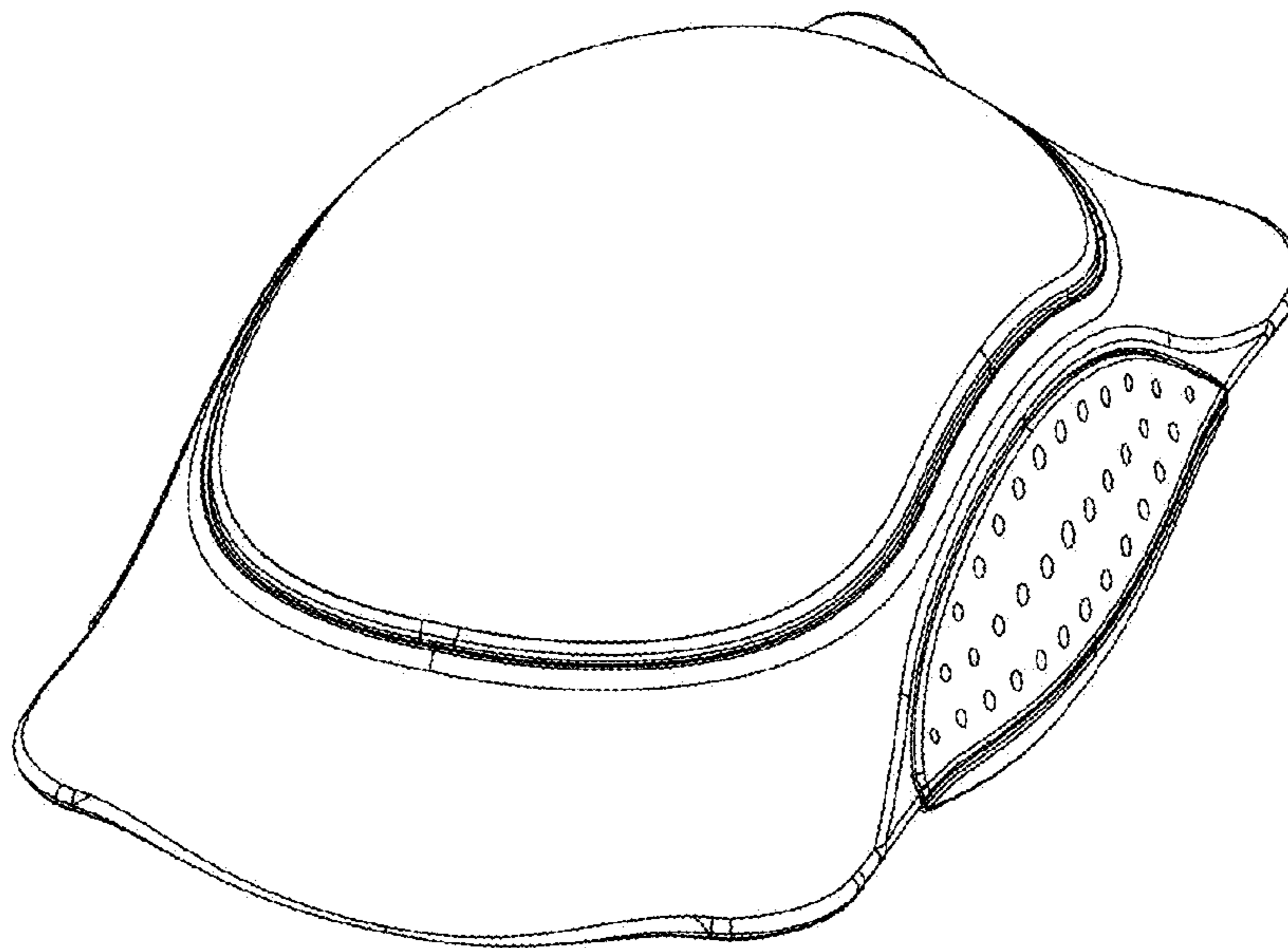
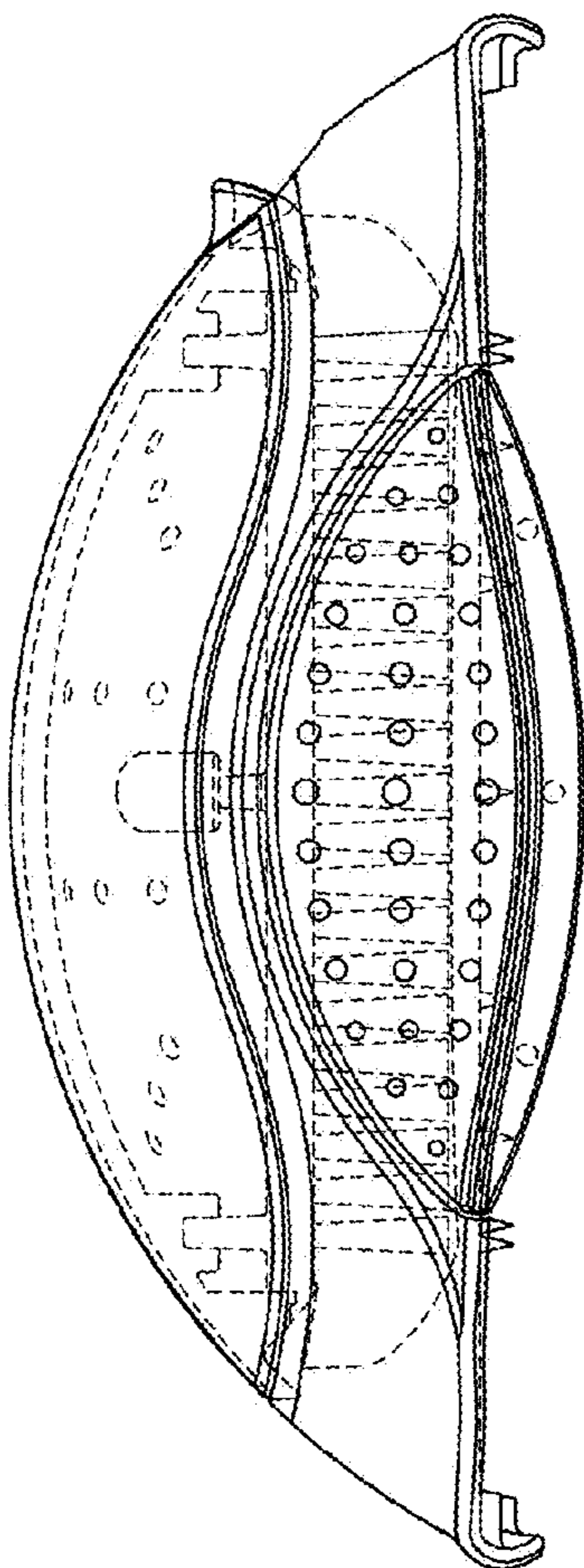

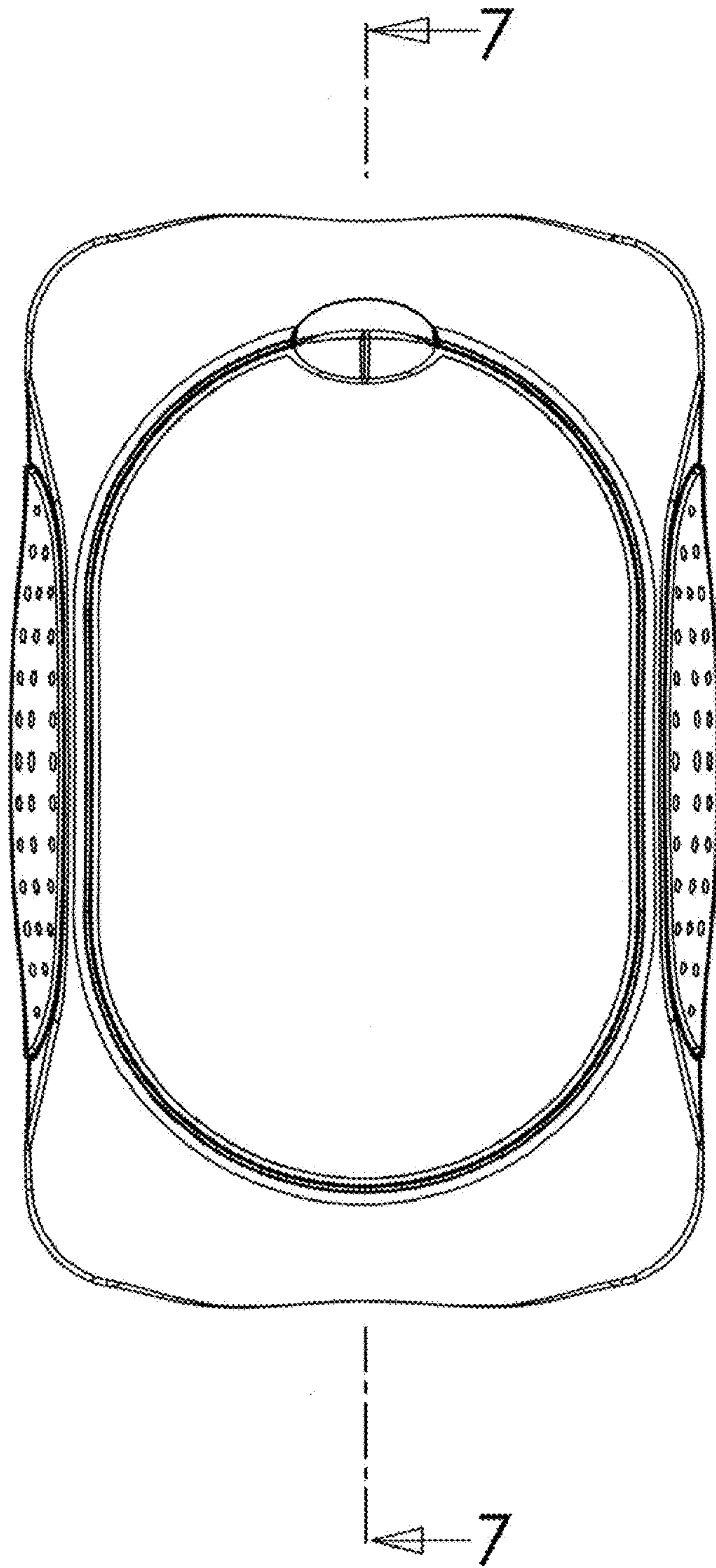

FIG. 1

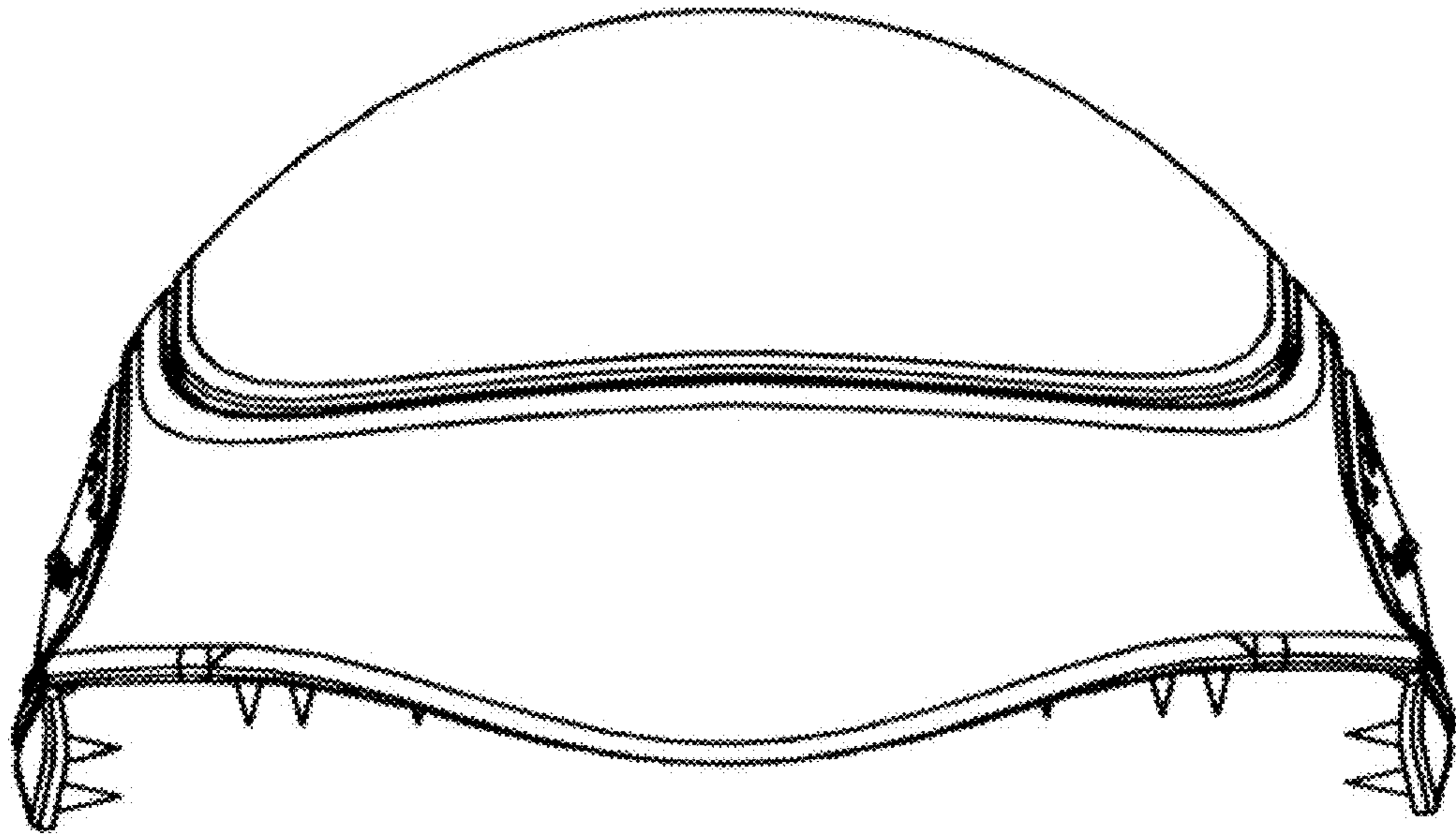

FIG. 2

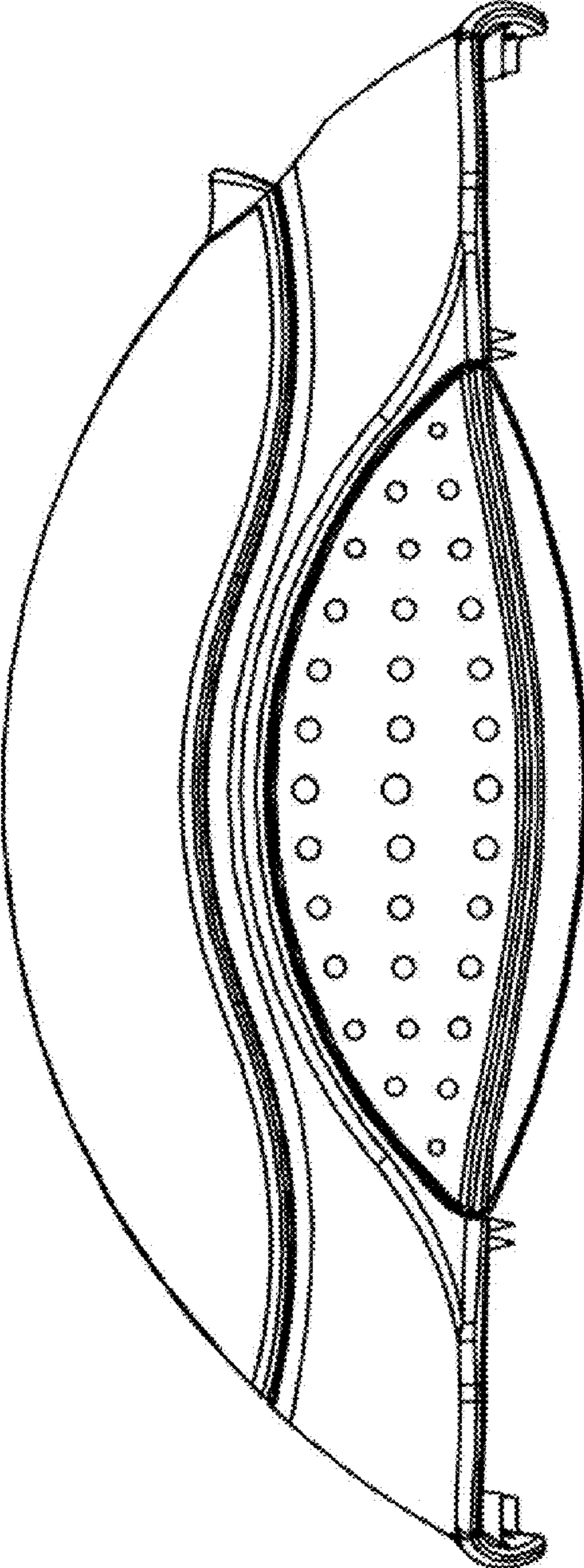

FIG. 3

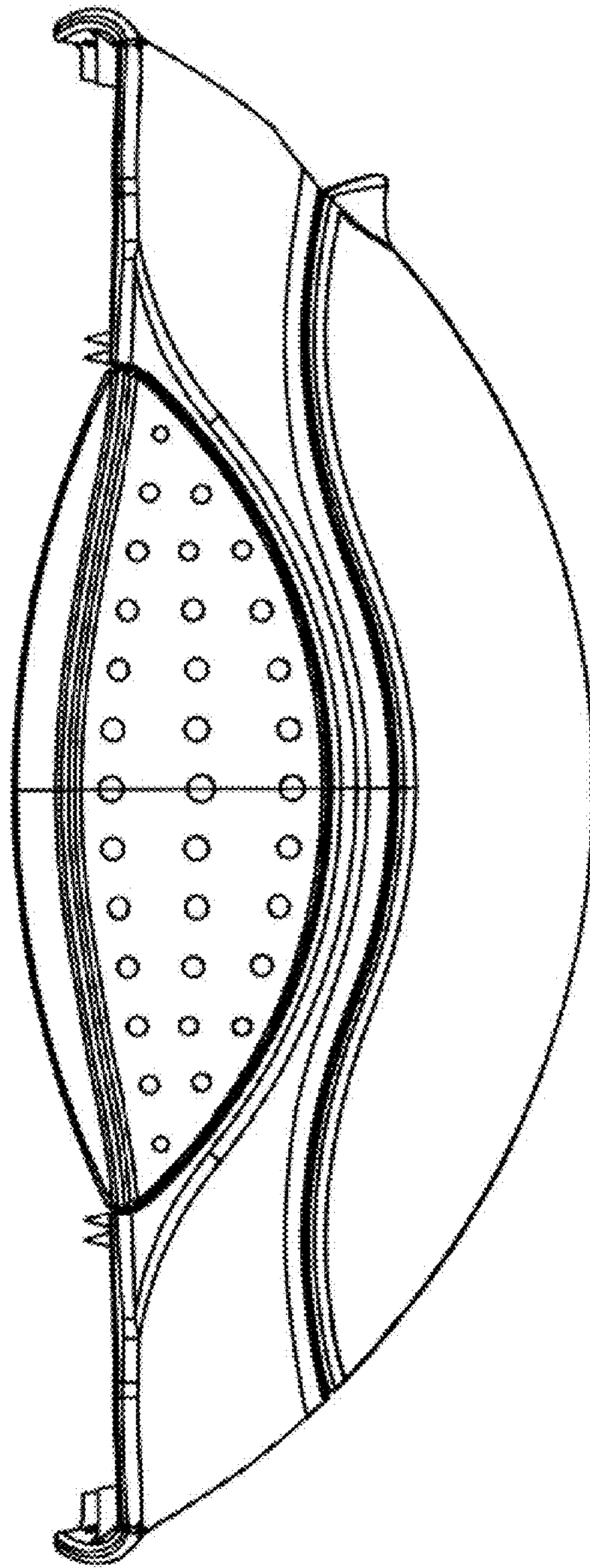

FIG. 4

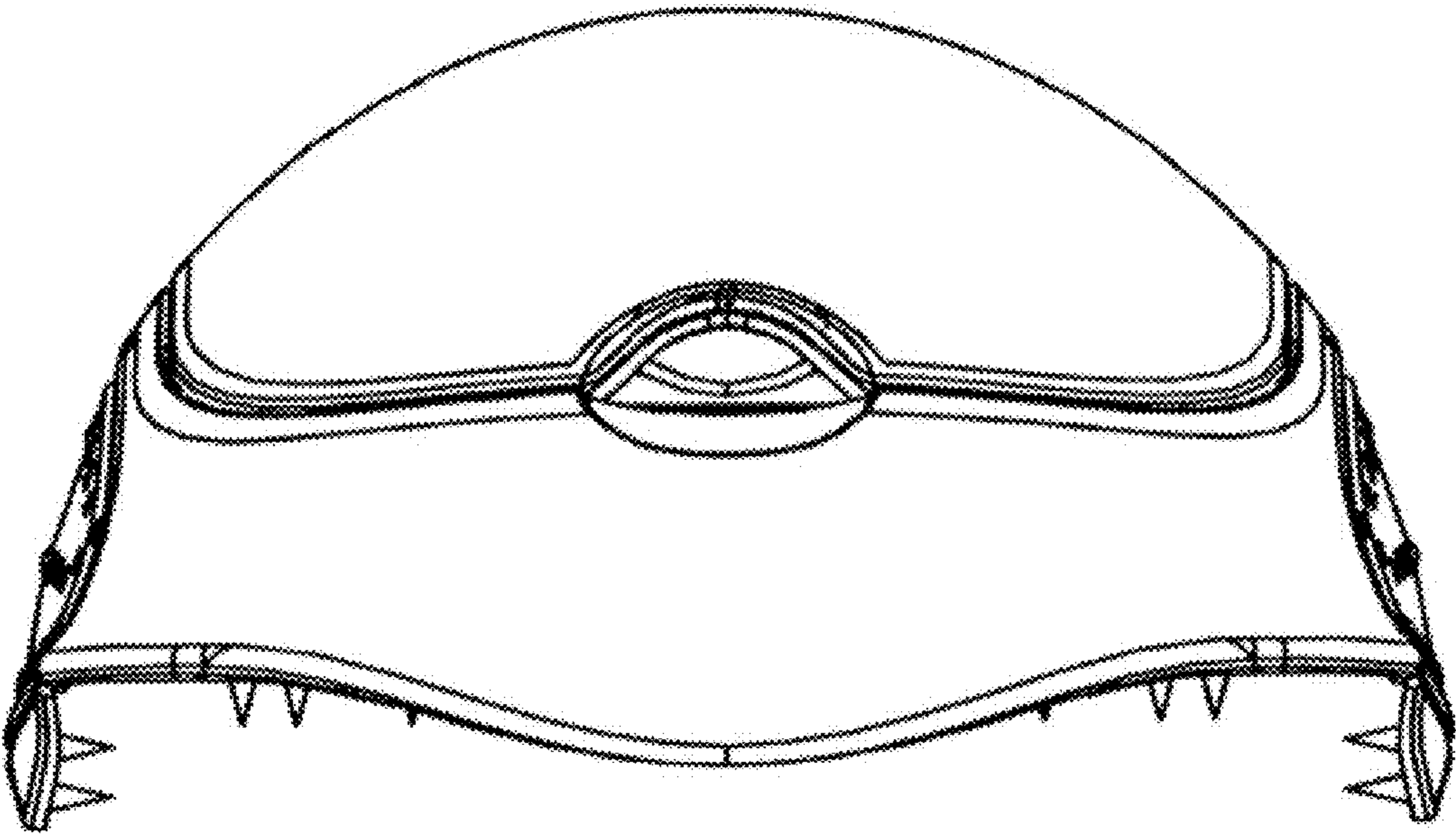

FIG. 5

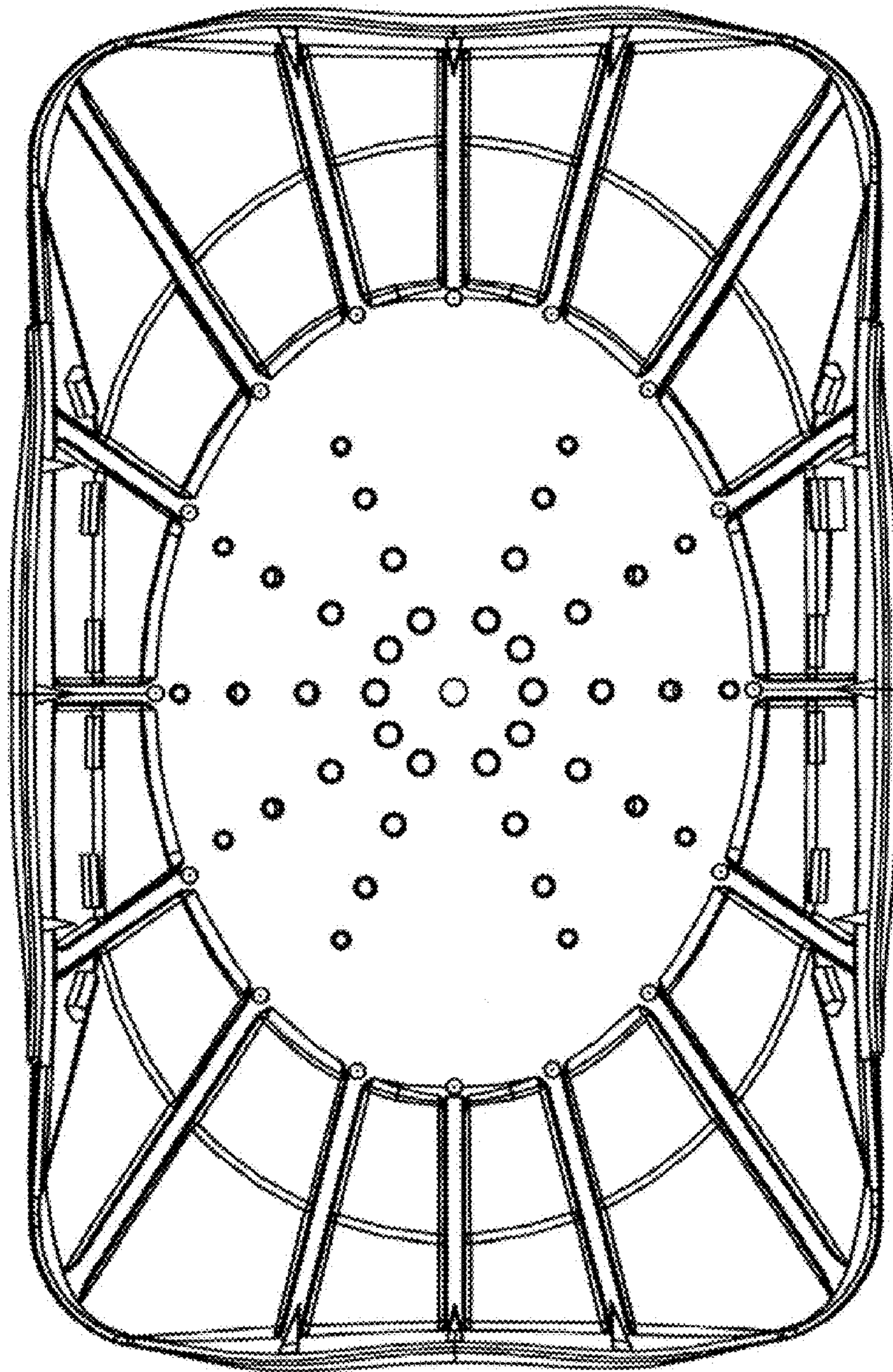

FIG. 6

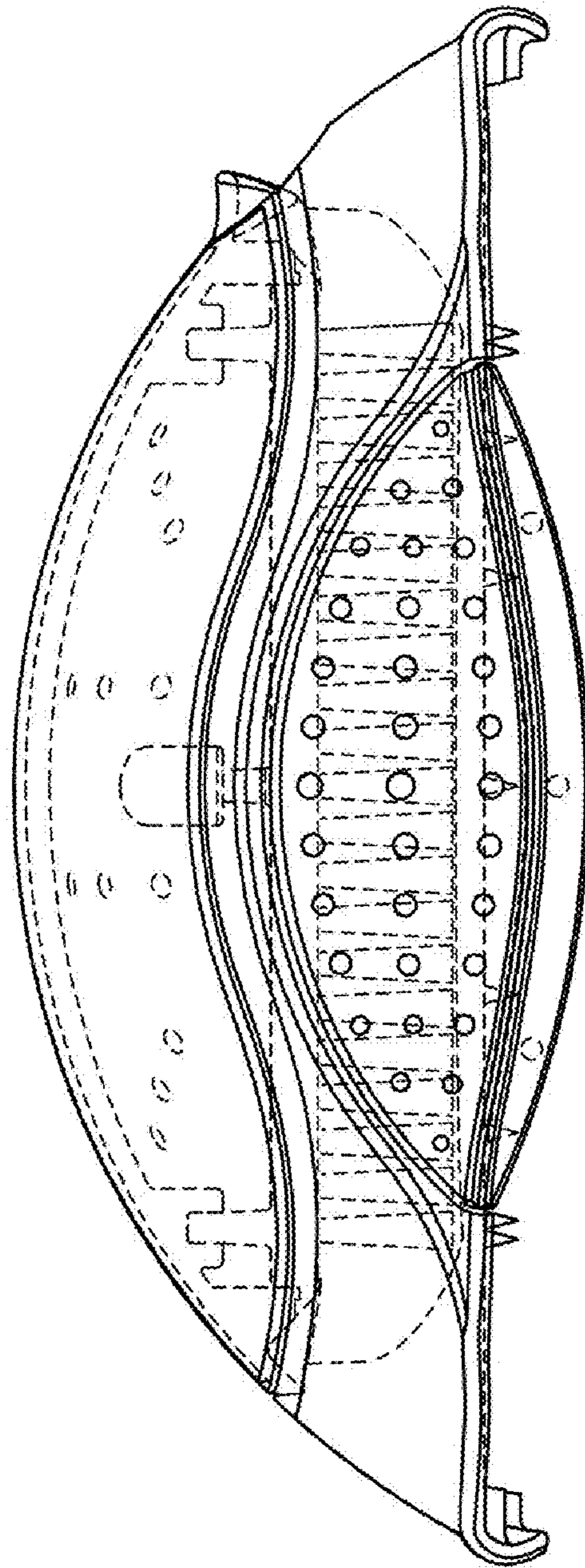

FIG. 7

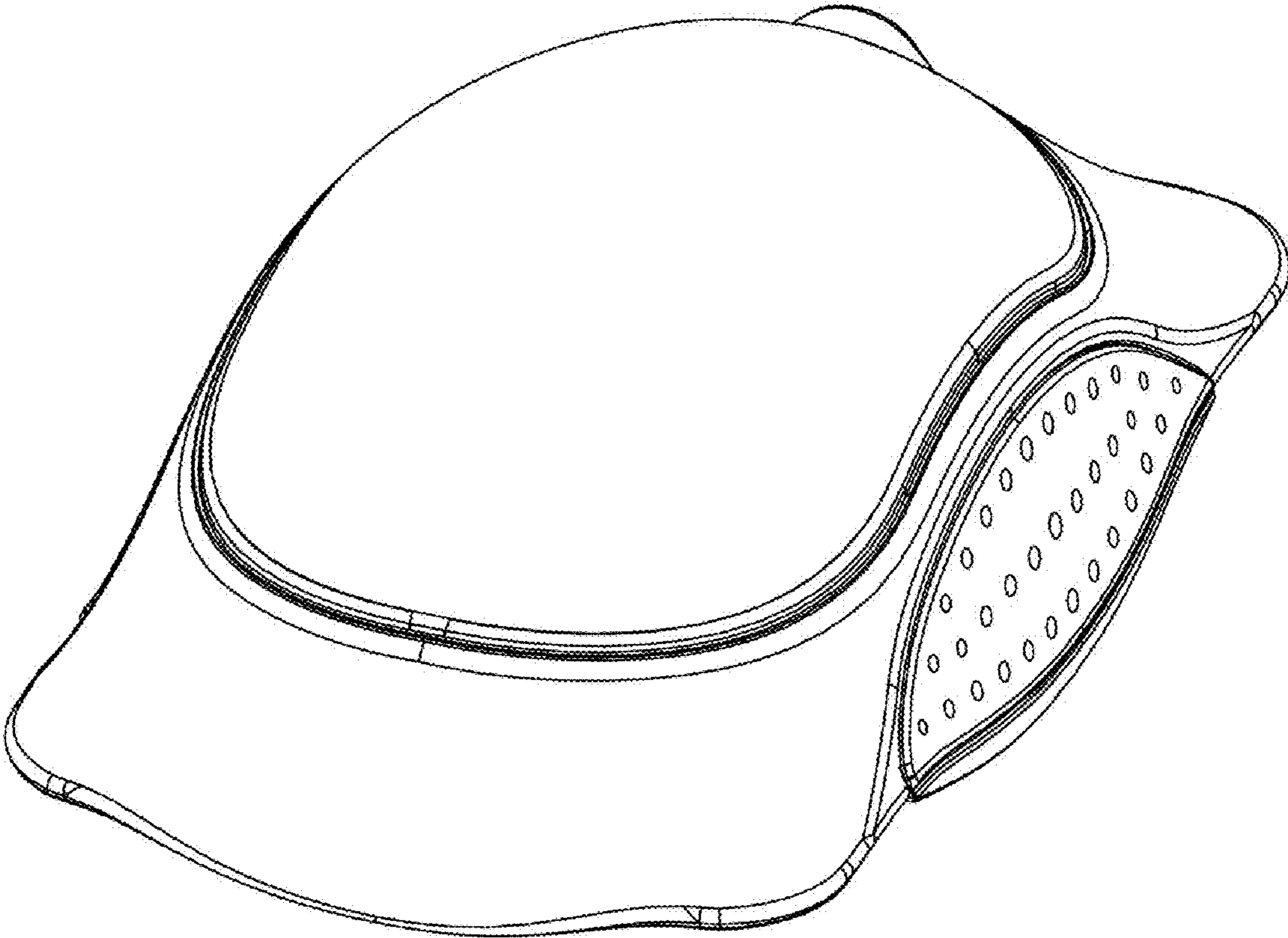

FIG. 8