



US00D653767S

(12) **United States Design Patent**  
**Lovshe**

(10) **Patent No.:** **US D653,767 S**  
(45) **Date of Patent:** **\*\* Feb. 7, 2012**

(54) **VIAL CONTAINER**

(76) Inventor: **Rita Lovshe**, St. Peters, MO (US)

(\*\*) Term: **14 Years**

(21) Appl. No.: **29/318,137**

(22) Filed: **May 14, 2008**

(51) **LOC (9) Cl.** ..... **24-02**

(52) **U.S. Cl.** ..... **D24/230; D9/756**

(58) **Field of Classification Search** ..... D9/756-762,  
D9/721, 455; D3/304; D24/224-227, 229,  
D24/230; 211/71.01, 85.13, 74; 217/58;  
206/563; 422/63, 64, 266, 297, 300  
See application file for complete search history.

(56) **References Cited**

**U.S. PATENT DOCUMENTS**

2,547,716	A *	4/1951	Murphy	206/562
2,981,039	A *	4/1961	Pohl	53/457
3,209,980	A *	10/1965	Festa	206/521.1
3,840,171	A *	10/1974	Waters	206/562
3,949,930	A *	4/1976	Giordano	206/562
4,053,099	A *	10/1977	Lock	206/562
4,394,905	A *	7/1983	Hackenberg	206/486
D303,149	S *	8/1989	Andersen	D24/226
4,973,315	A *	11/1990	Sincock	604/192
D338,965	S *	8/1993	Glanz et al.	D24/226
D359,126	S *	6/1995	Hovatter	D24/227
5,540,334	A *	7/1996	Haas et al.	206/563
5,603,899	A *	2/1997	Franciskovich et al.	422/527
5,765,690	A *	6/1998	Baxter	206/562
5,817,510	A *	10/1998	Pandey et al.	435/305.3
D411,308	S *	6/1999	Pandey et al.	D24/230
D420,743	S *	2/2000	Monks	D24/224
6,258,327	B1	7/2001	Tatum	
6,296,120	B1 *	10/2001	Danko	206/564
6,311,842	B1 *	11/2001	Minerich et al.	206/562
D515,941	S *	2/2006	Hamblin et al.	D9/756
D515,942	S *	2/2006	Hamblin et al.	D9/756
D515,943	S *	2/2006	Hamblin et al.	D9/756
D538,538	S *	3/2007	Espinosa	D3/313
D624,661	S *	9/2010	Himmelsbach et al.	D24/230

D625,431	S *	10/2010	Karpiloff	D24/230
D628,305	S *	11/2010	Gorrec et al.	D24/229
D628,306	S *	11/2010	Blanc et al.	D24/230
D629,121	S *	12/2010	Karpiloff	D24/230
D629,122	S *	12/2010	Karpiloff	D24/230
D632,404	S *	2/2011	Karpiloff	D24/230
D639,447	S *	6/2011	Karpiloff	D24/230
D645,156	S *	9/2011	Reitze	D24/227
2002/0108880	A1 *	8/2002	Krupa et al.	206/497

\* cited by examiner

*Primary Examiner* — Mark Goodwin

(74) *Attorney, Agent, or Firm* — Polster, Lieder, Woodruff & Lucchesi, LC

(57) **CLAIM**

The ornamental design for a vial container, as shown and described.

**DESCRIPTION**

FIG. 1 is a front perspective view of a vial container;  
 FIG. 2 is a front elevational view thereof wherein the rear elevational view is a mirror image;  
 FIG. 3 is side elevational view thereof wherein the other side is a mirror image;  
 FIG. 4 is a top view thereof;  
 FIG. 5 is a bottom view thereof;  
 FIG. 6 is front perspective view of a second embodiment of a vial container;  
 FIG. 7 is a front elevational view thereof wherein the rear elevational view is a mirror image;  
 FIG. 8 side elevational view thereof wherein the other side is a mirror image; and,  
 FIG. 9 is an enlarged view of the front or side view of the second embodiment to illustrate indicia.  
 The top view and bottom view of the second embodiment are mirror images of the first embodiment.  
 All broken lines are for illustrative purposes only, and form no part of the claimed design.

**1 Claim, 4 Drawing Sheets**

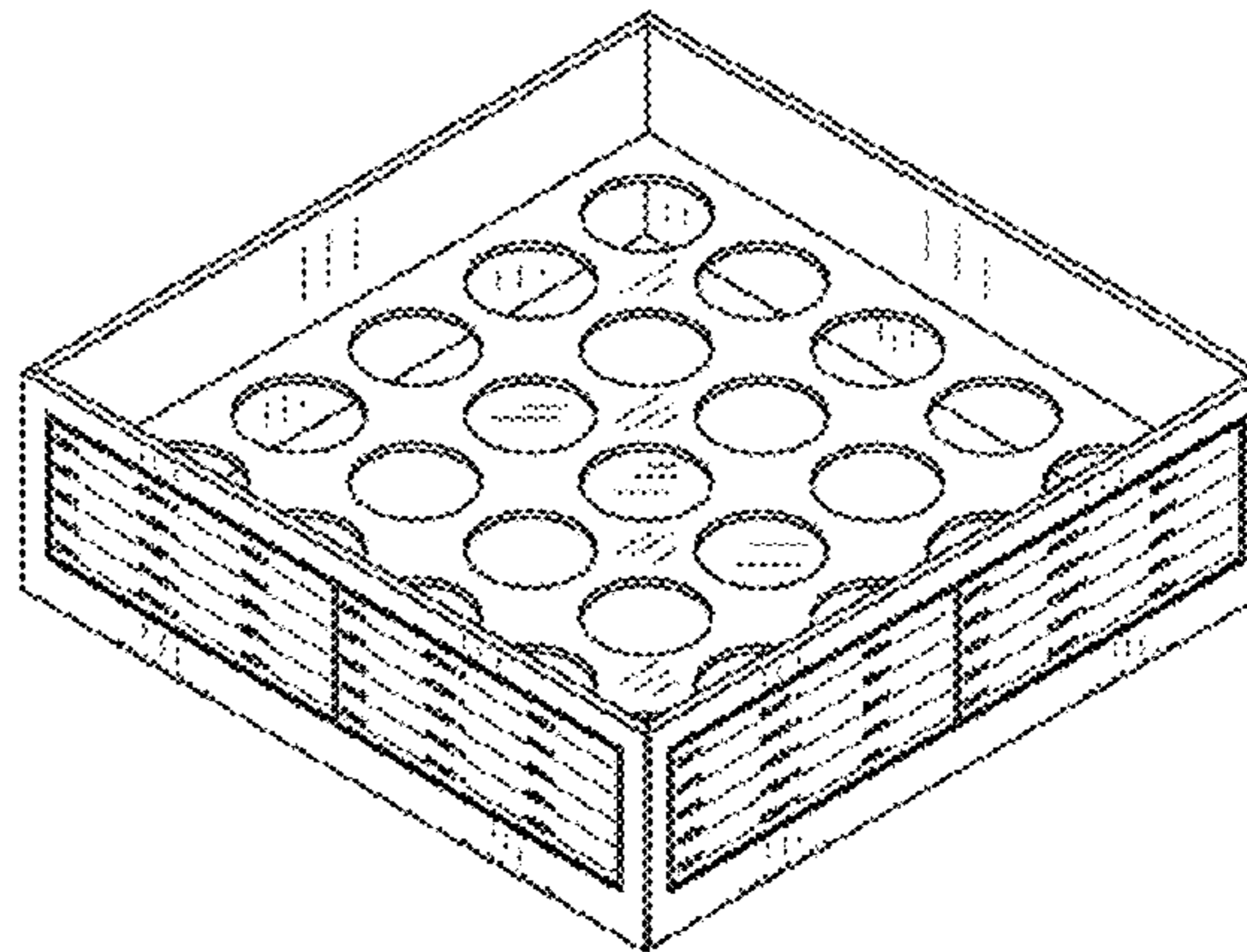
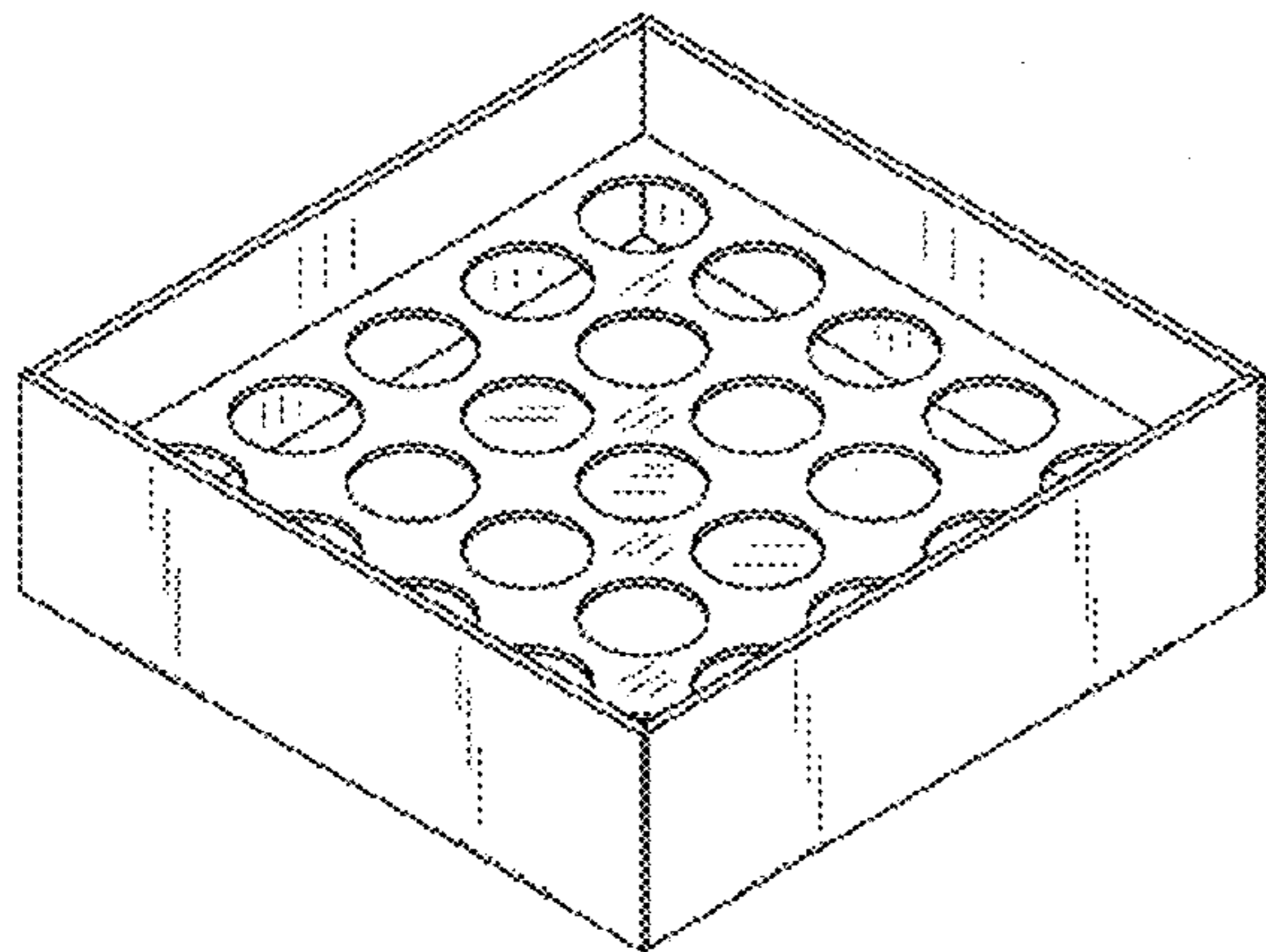

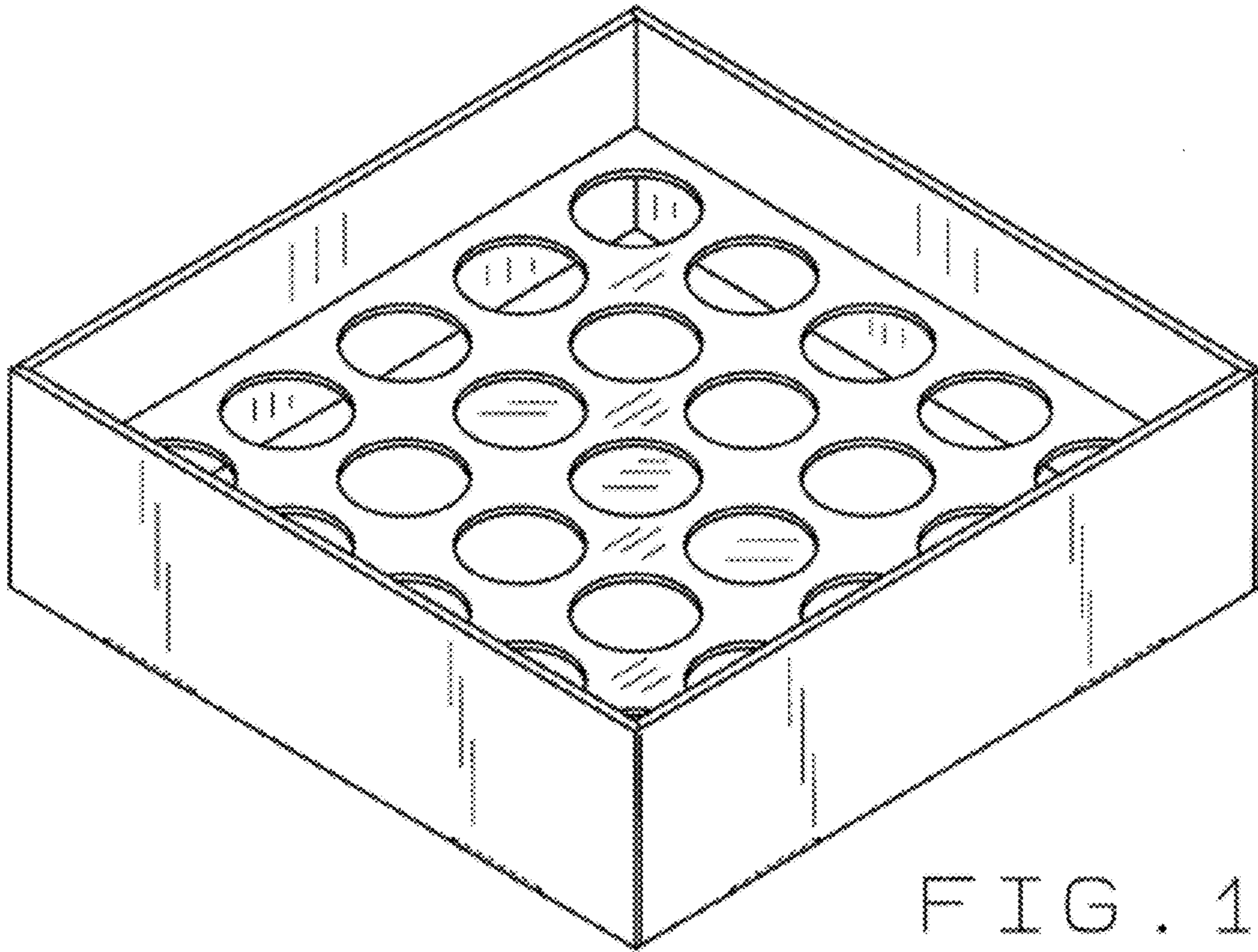

FIG. 1



FIG. 2



FIG. 3

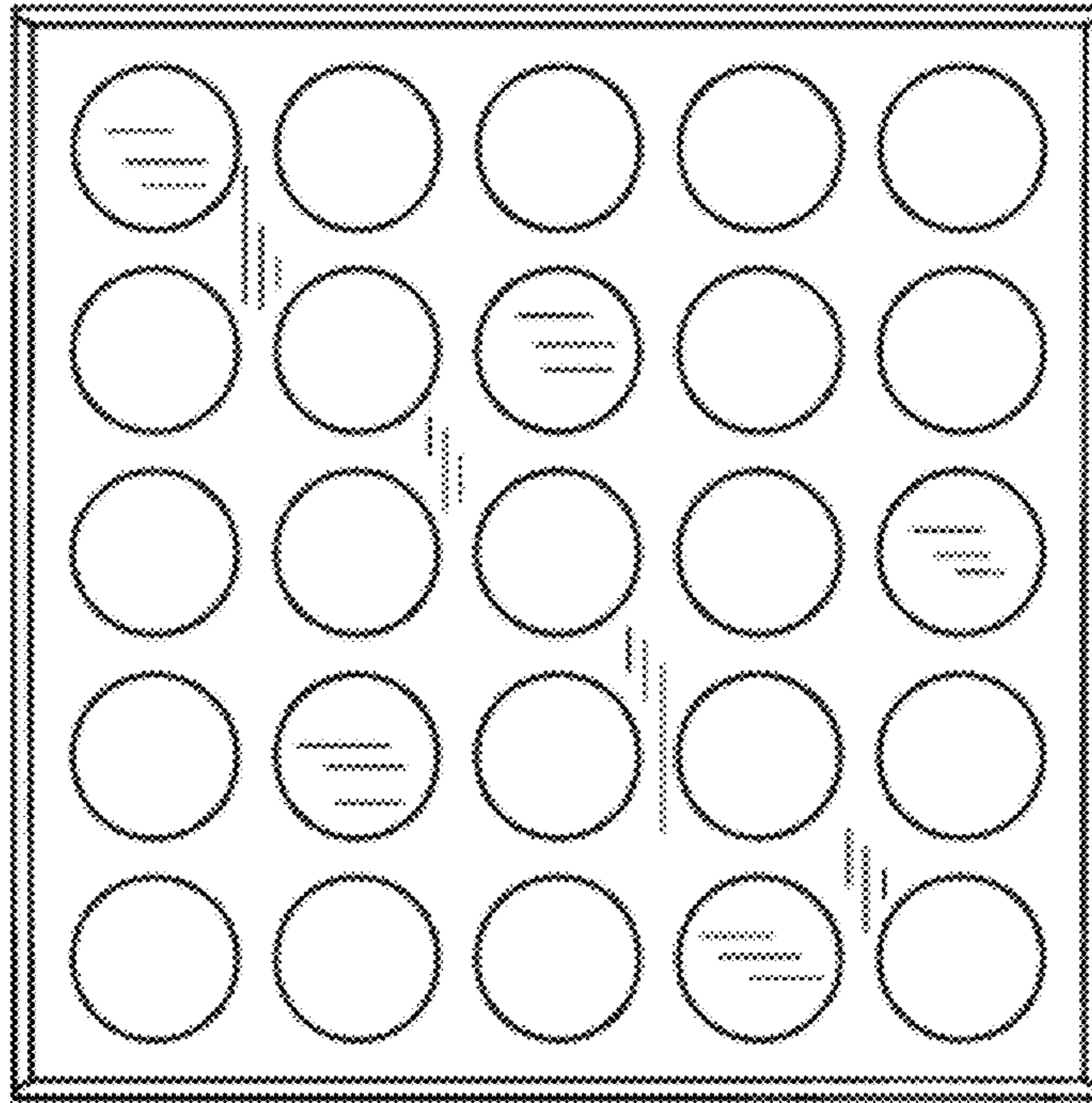

FIG. 4

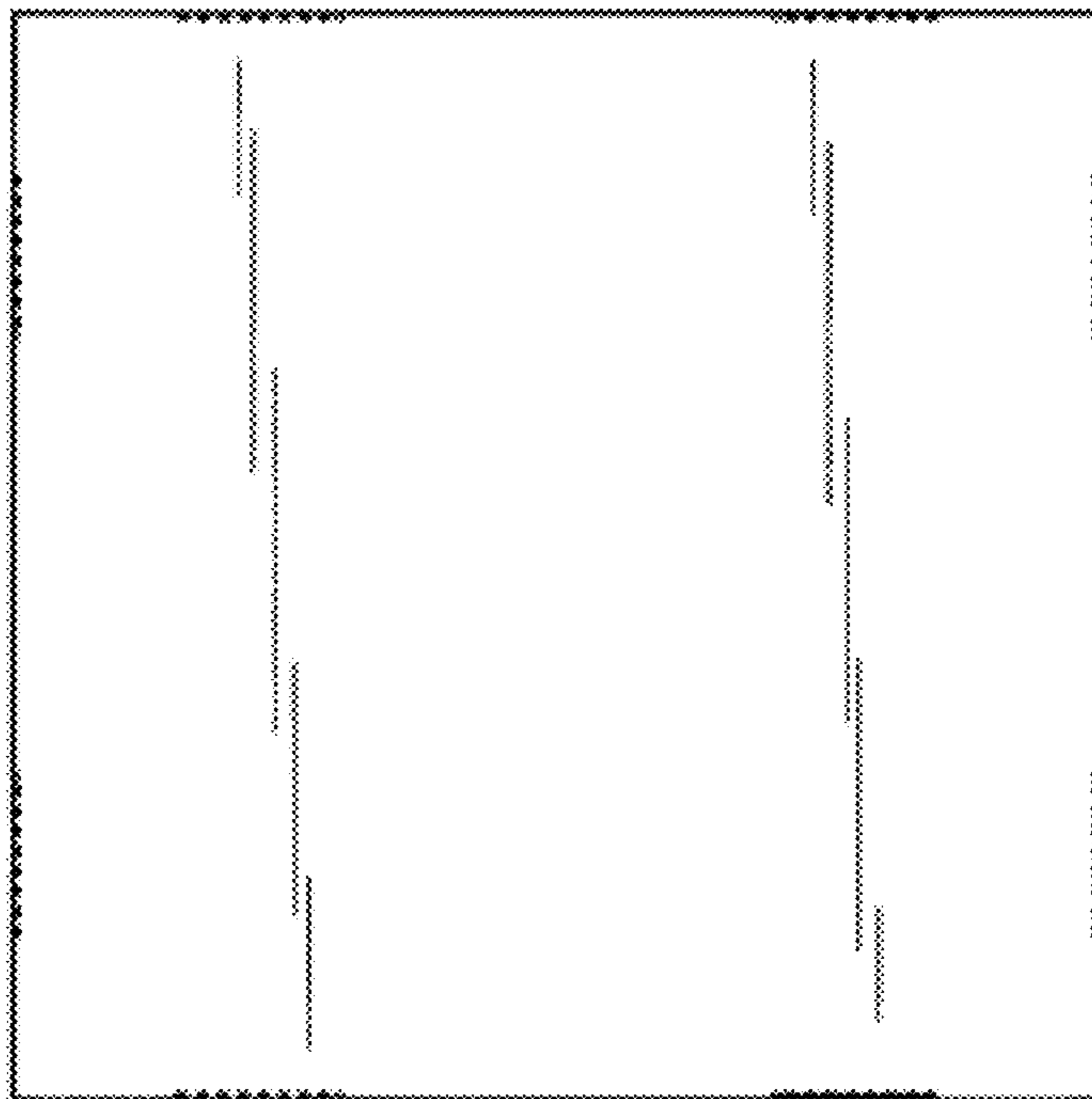

FIG. 5

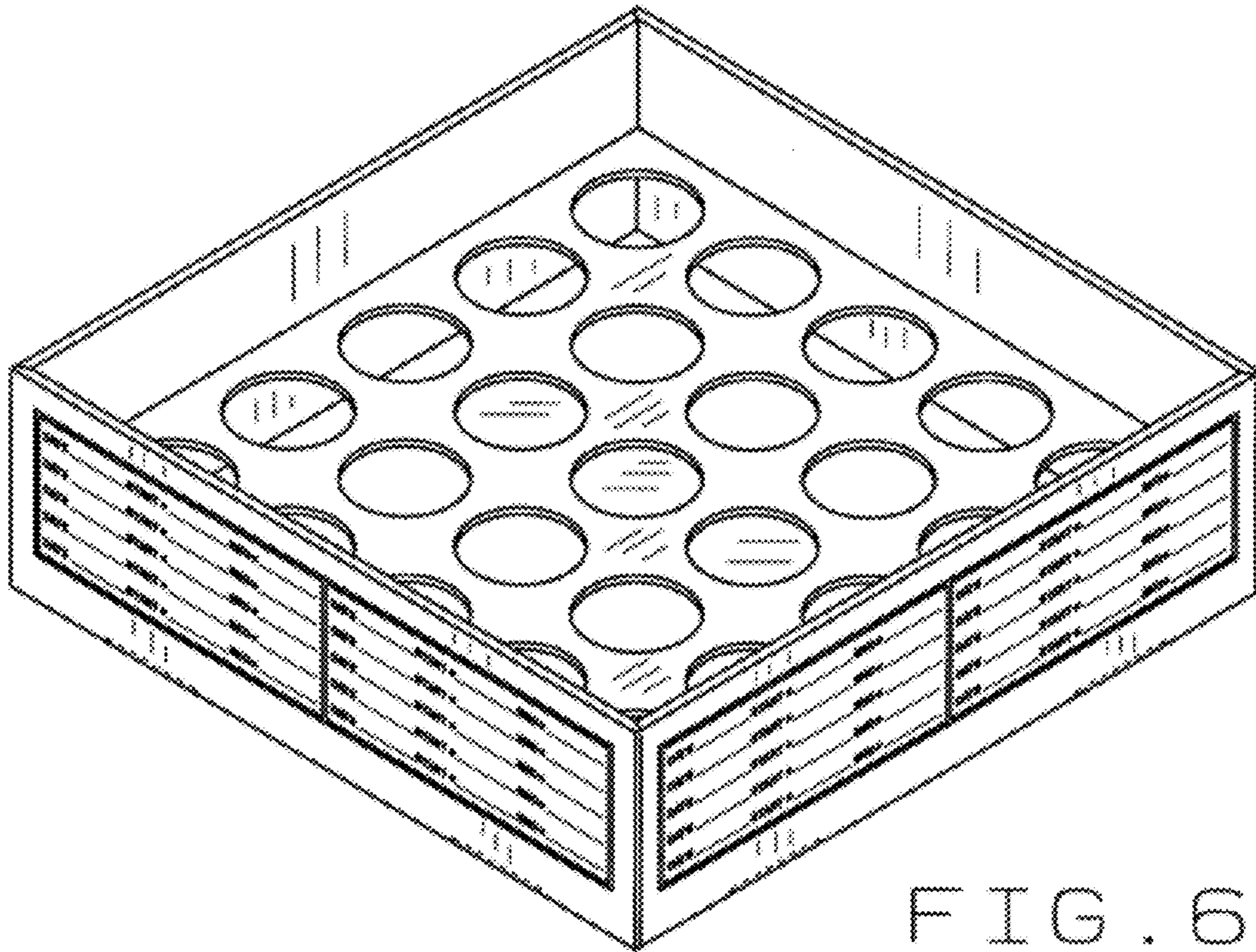

FIG. 6

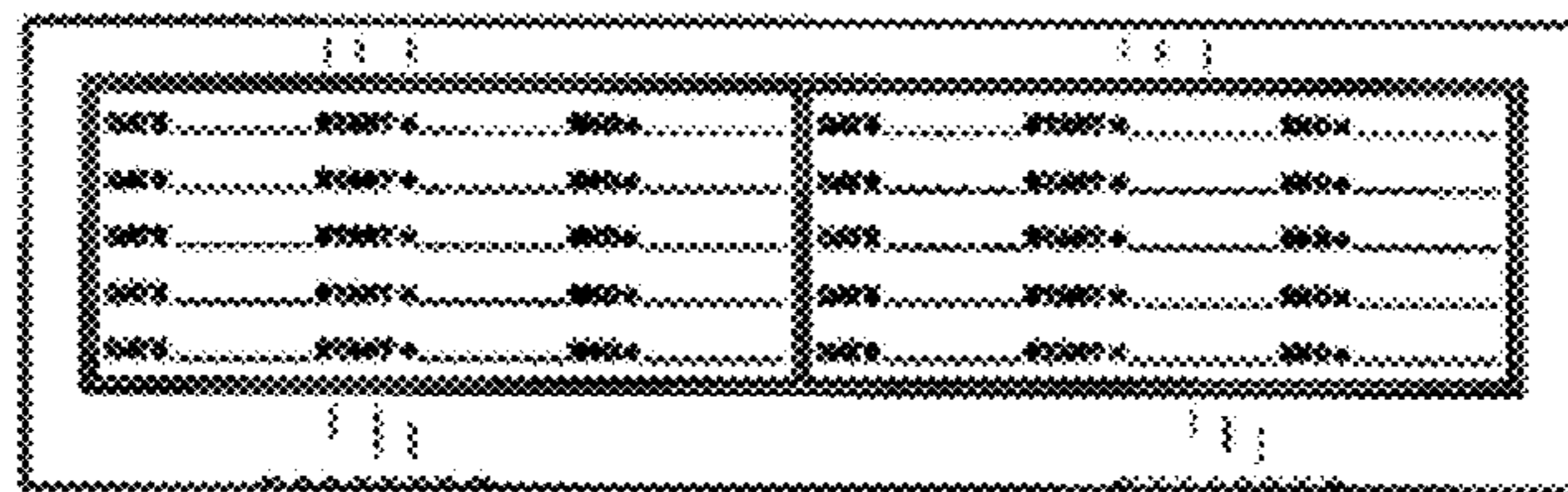

FIG. 7

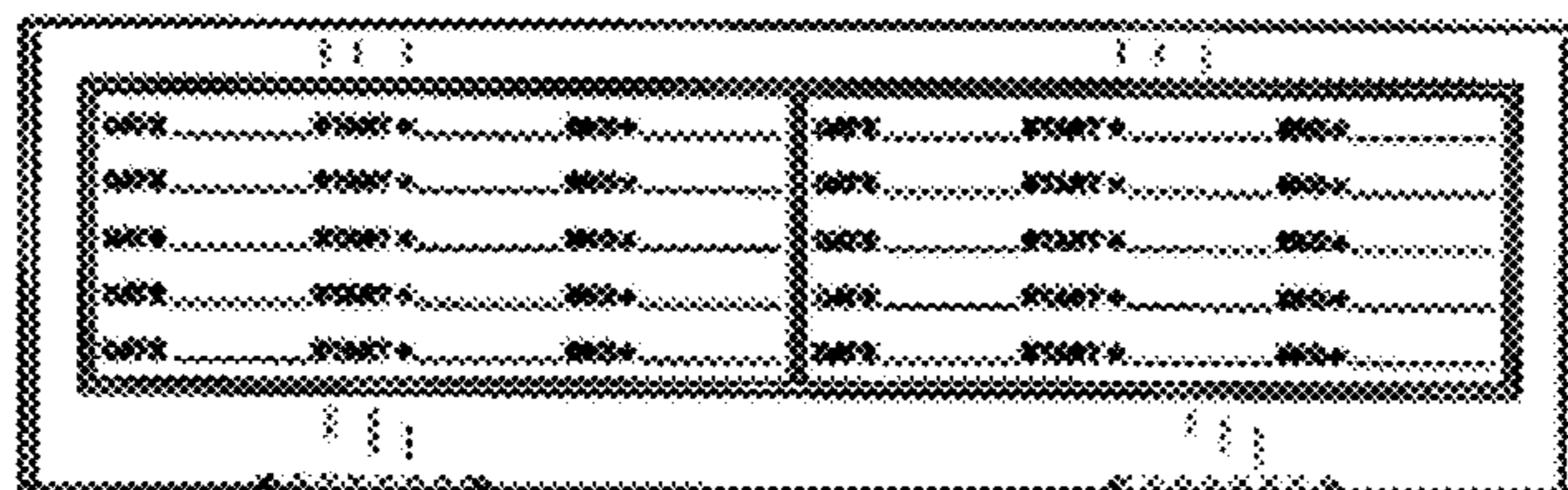

FIG. 8

DATE	START #	END #	DATE	START #	END #
DATE	START #	END #	DATE	START #	END #
DATE	START #	END #	DATE	START #	END #
DATE	START #	END #	DATE	START #	END #
DATE	START #	END #	DATE	START #	END #

FIG. 9