



US00D653704S

(12) **United States Design Patent**  
**Seki et al.**

(10) **Patent No.:** **US D653,704 S**  
(45) **Date of Patent:** **\*\* Feb. 7, 2012**

(54) **PRINTER**

(75) Inventors: **Yusaku Seki**, Nagoya (JP); **Jiro Suzuki**, Nagoya (JP)

(73) Assignee: **Brother Industries, Ltd.**, Nagoya (JP)

(\*\*) Term: **14 Years**

(21) Appl. No.: **29/378,682**

(22) Filed: **Nov. 8, 2010**

(30) **Foreign Application Priority Data**

May 12, 2010 (JP) ..... 2010-11650

(51) **LOC (9) Cl.** ..... **14-02**

(52) **U.S. Cl.** ..... **D18/55**

(58) **Field of Classification Search** ..... D14/420-425,  
D14/463-470; D18/14, 19, 36-37, 50, 54,  
D18/54.1, 55; 400/613, 613.1-613.4, 690,  
400/690.1-690.4, 691-694

See application file for complete search history.

(56) **References Cited**

**U.S. PATENT DOCUMENTS**

D412,182 S \* 7/1999 Miyazawa ..... D18/55  
D521,060 S \* 5/2006 Katayama ..... D18/55

D544,906 S \* 6/2007 Alfonso et al. .... D18/55  
D552,170 S \* 10/2007 Kim et al. .... D18/55  
D558,266 S \* 12/2007 Falk ..... D18/55  
D562,886 S \* 2/2008 Egami et al. .... D18/55  
D578,494 S \* 10/2008 Hattori ..... D18/55  
D584,348 S \* 1/2009 Boo et al. .... D18/55  
D601,186 S \* 9/2009 Kim et al. .... D18/55  
D607,928 S \* 1/2010 Kim et al. .... D18/55  
D617,829 S \* 6/2010 Suzuki et al. .... D18/55  
D639,847 S \* 6/2011 Nakata et al. .... D18/50  
2007/0014620 A1\* 1/2007 Sugimoto ..... 400/691

\* cited by examiner

*Primary Examiner* — Cathy A MacCormac

(74) *Attorney, Agent, or Firm* — Oliff & Berridge, PLC

(57) **CLAIM**

The ornamental design for a printer, as shown and described.

**DESCRIPTION**

FIG. 1 is a perspective view of a printer;

FIG. 2 is a front view thereof;

FIG. 3 is a top view thereof;

FIG. 4 is a right-side view thereof;

FIG. 5 is a left-side view thereof;

FIG. 6 is a rear view thereof; and,

FIG. 7 is a bottom view thereof.

The broken lines depict environmental subject matter only and form no part of the claimed design.

**1 Claim, 7 Drawing Sheets**

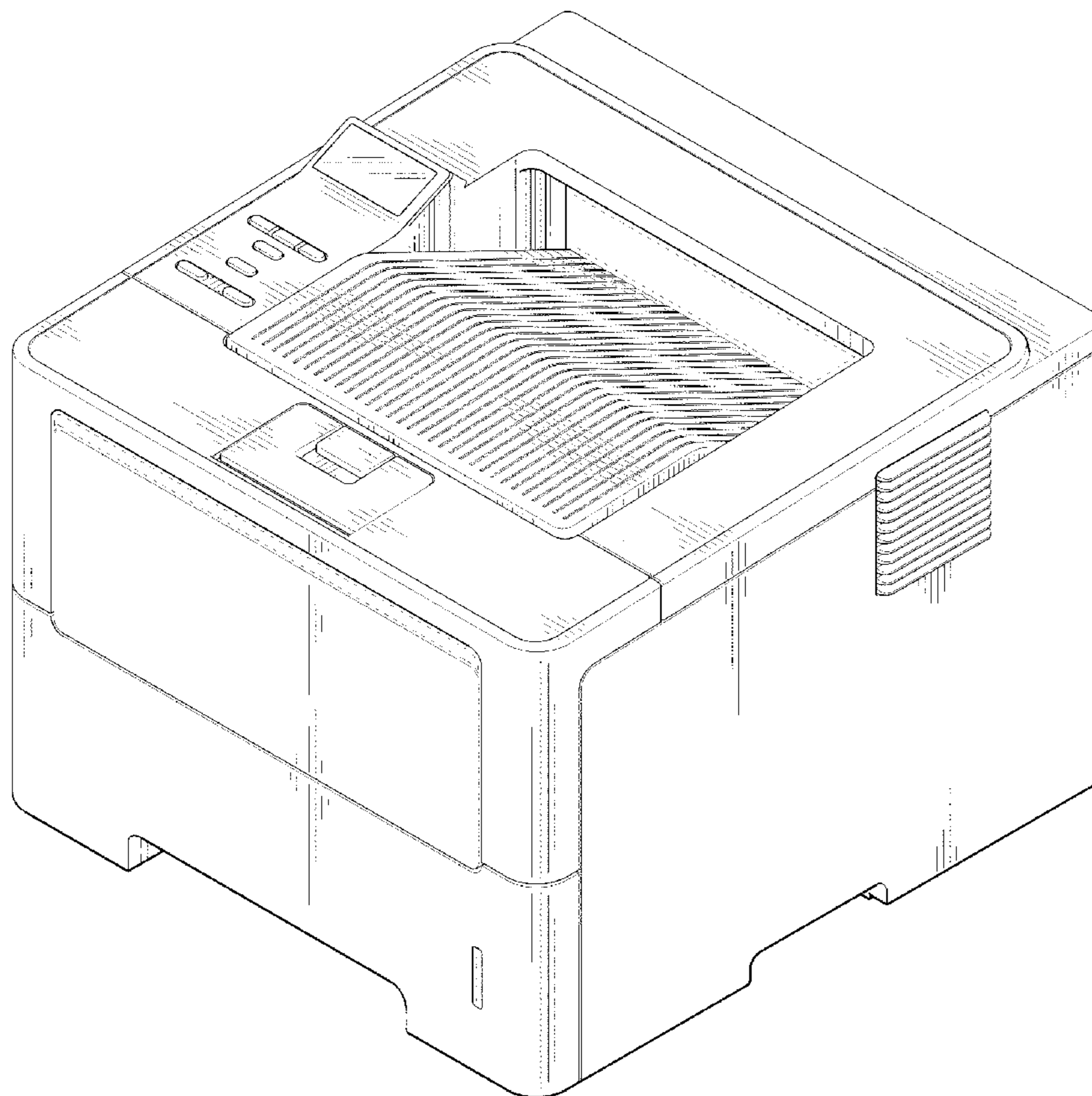

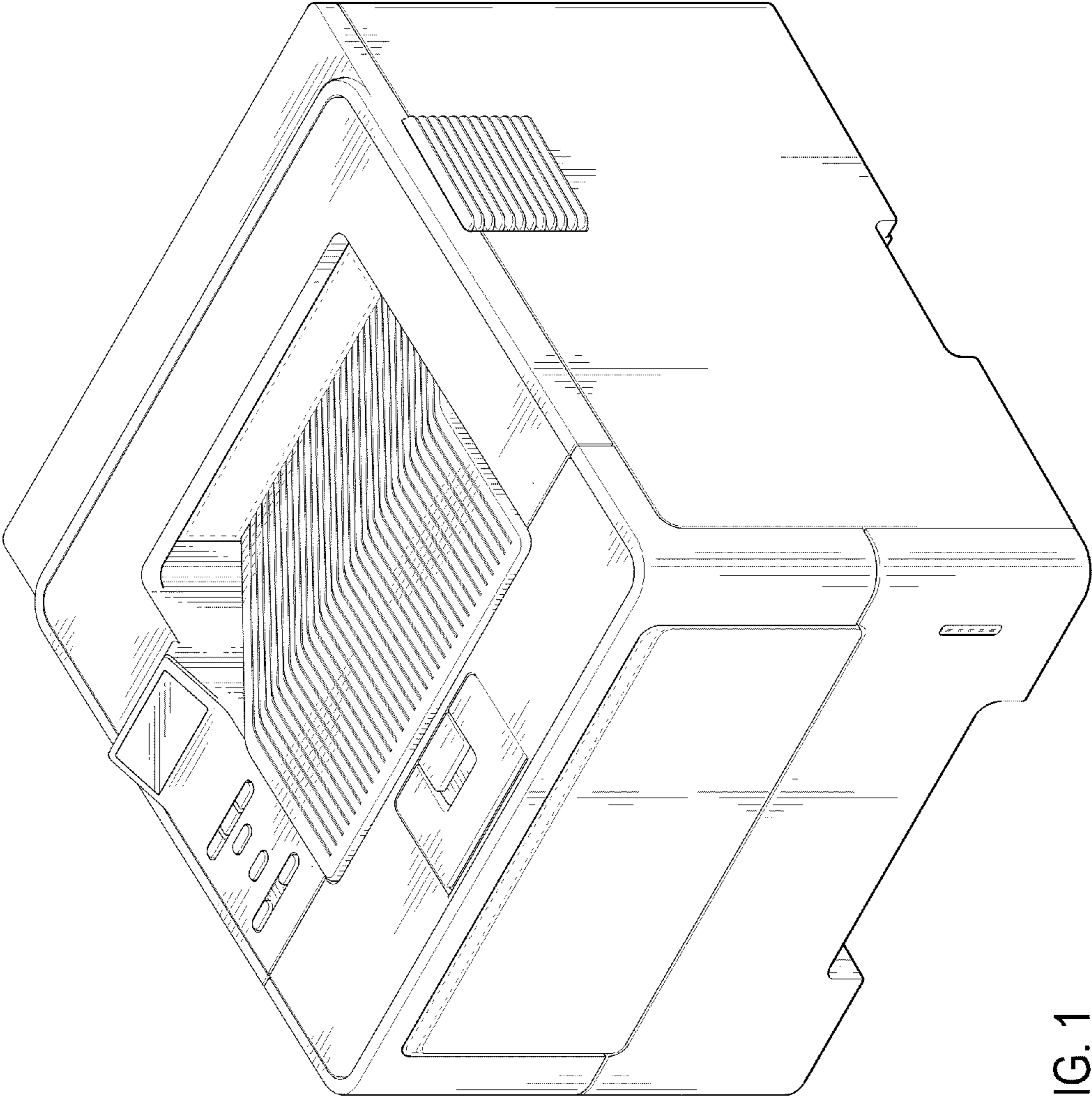

FIG. 1

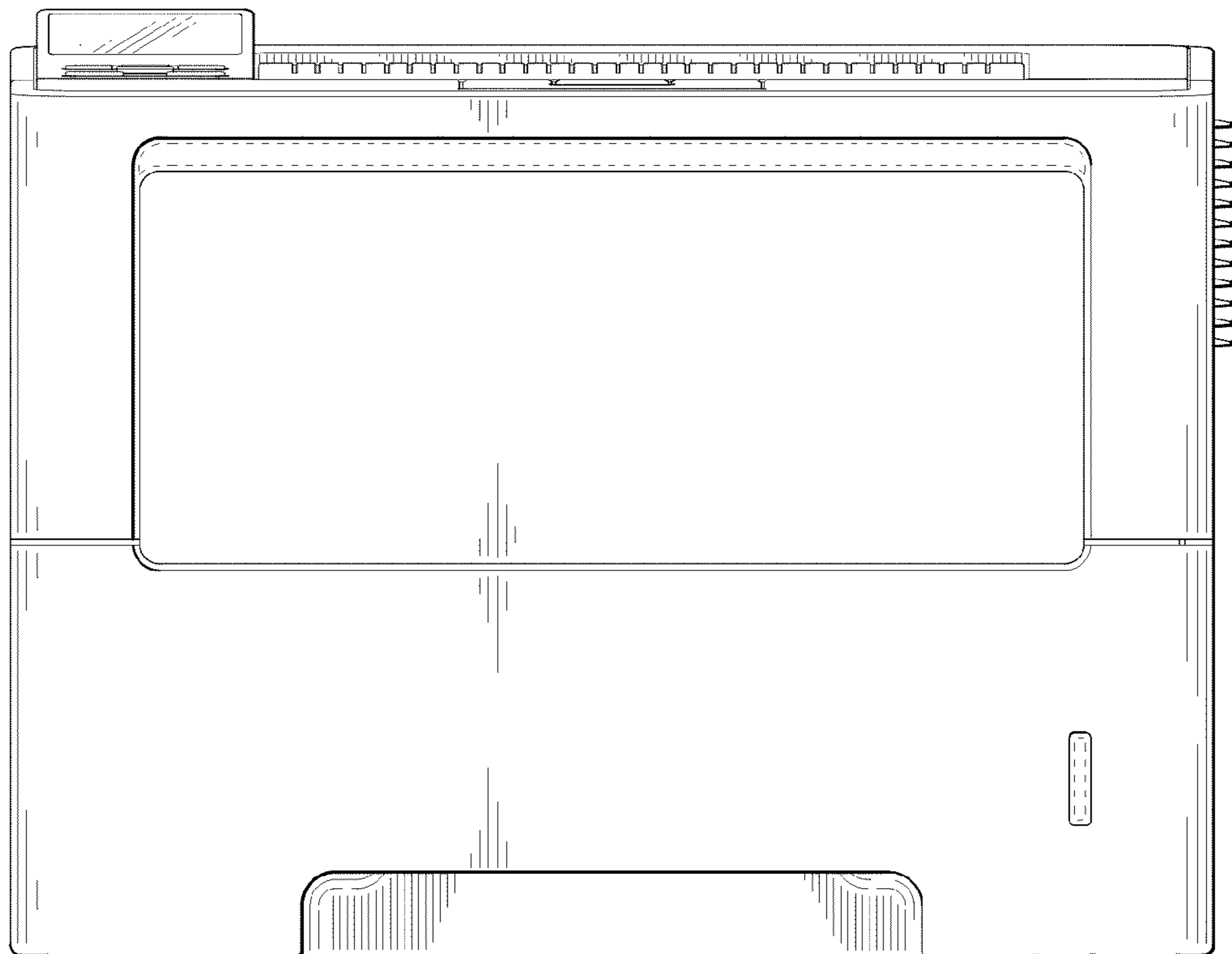

FIG. 2

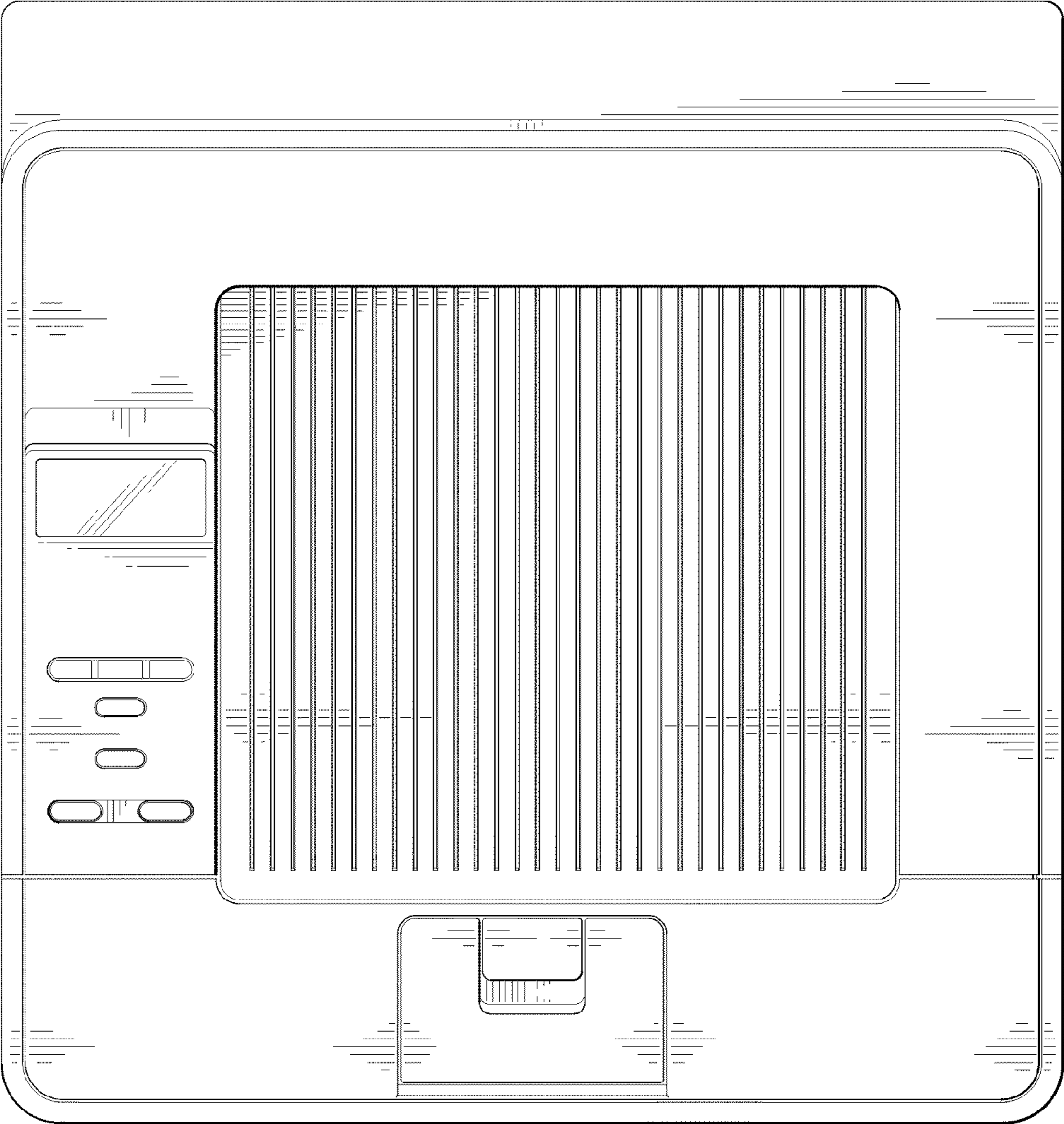

FIG. 3

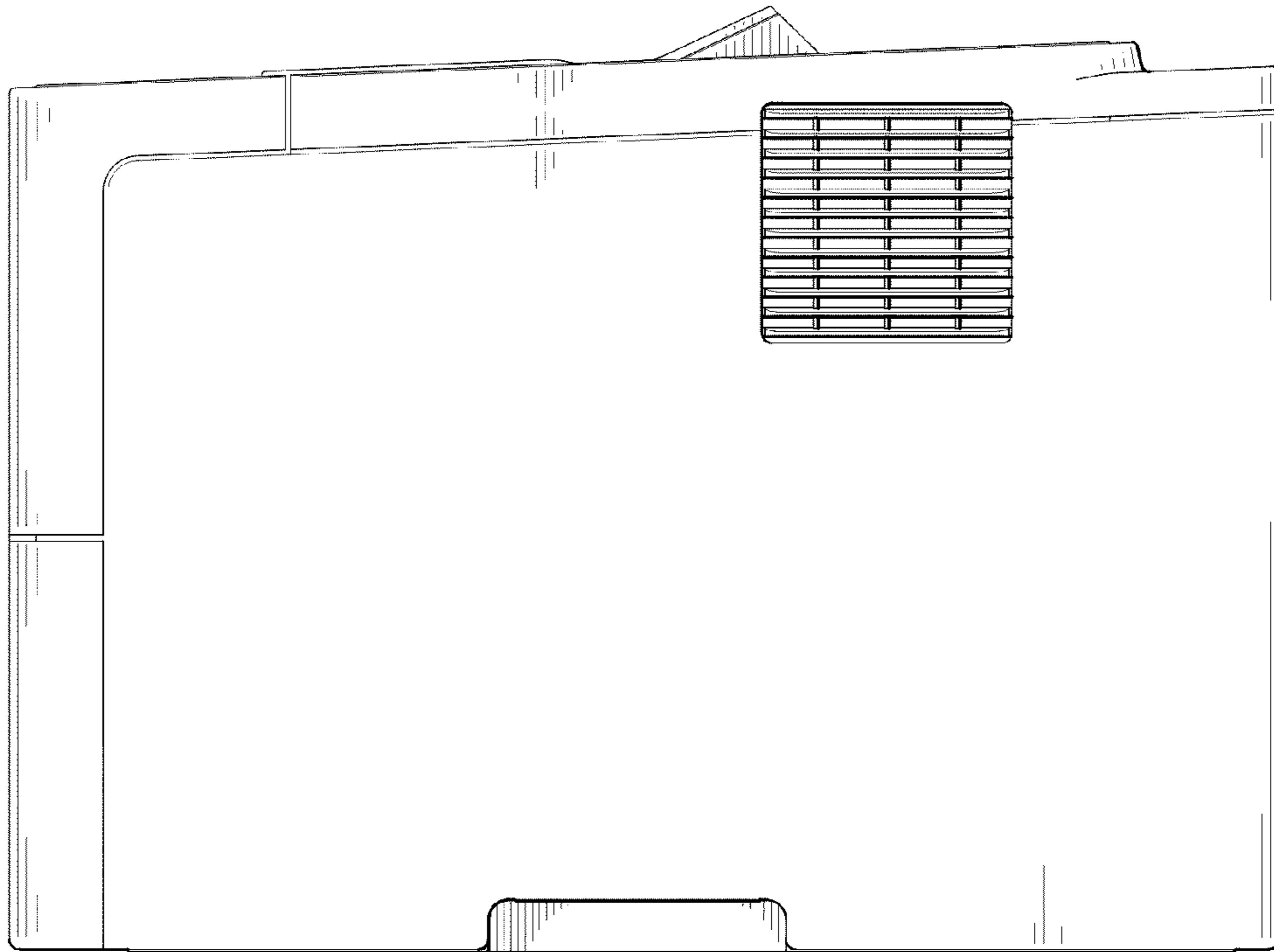

FIG. 4

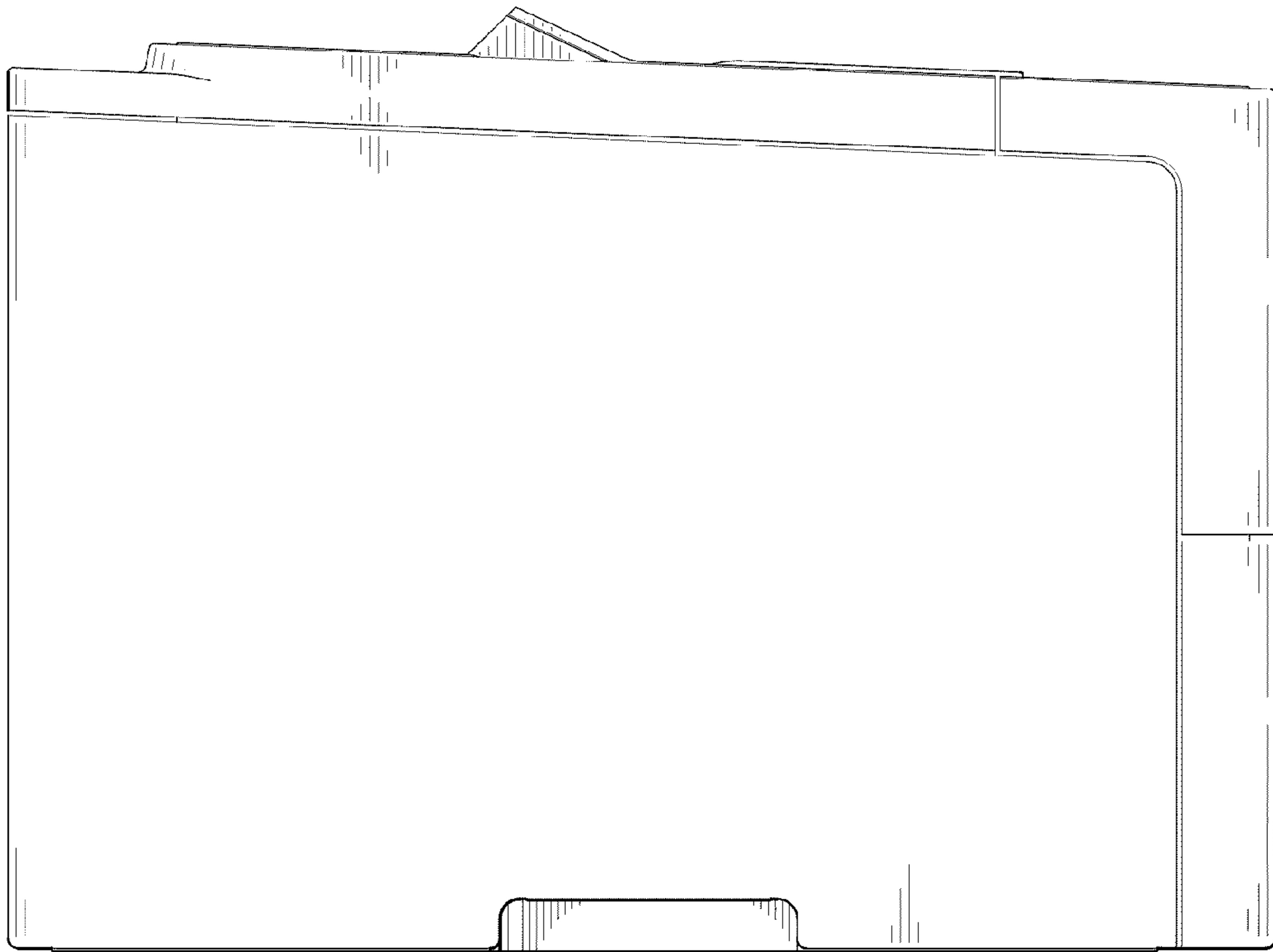

FIG. 5

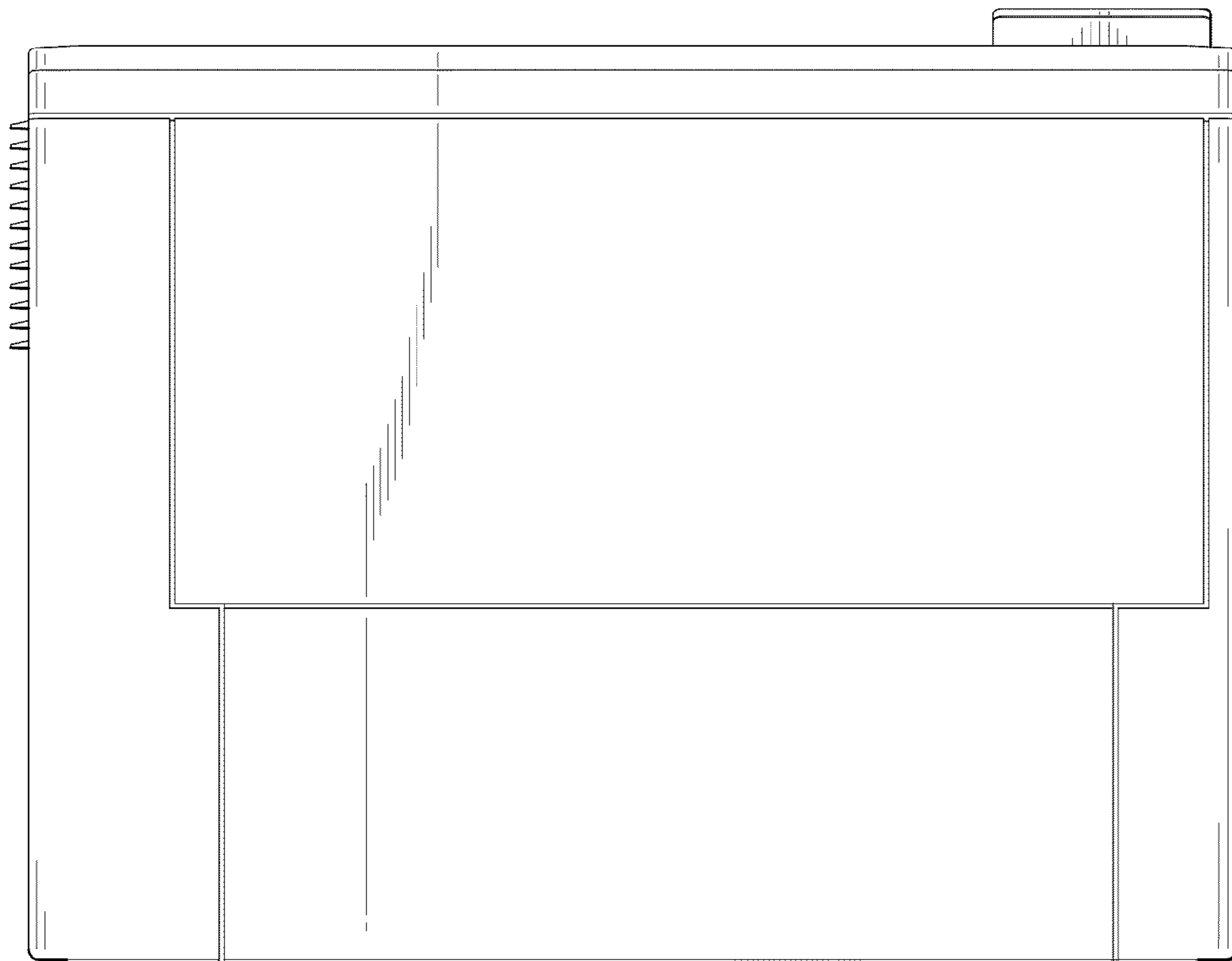

FIG. 6

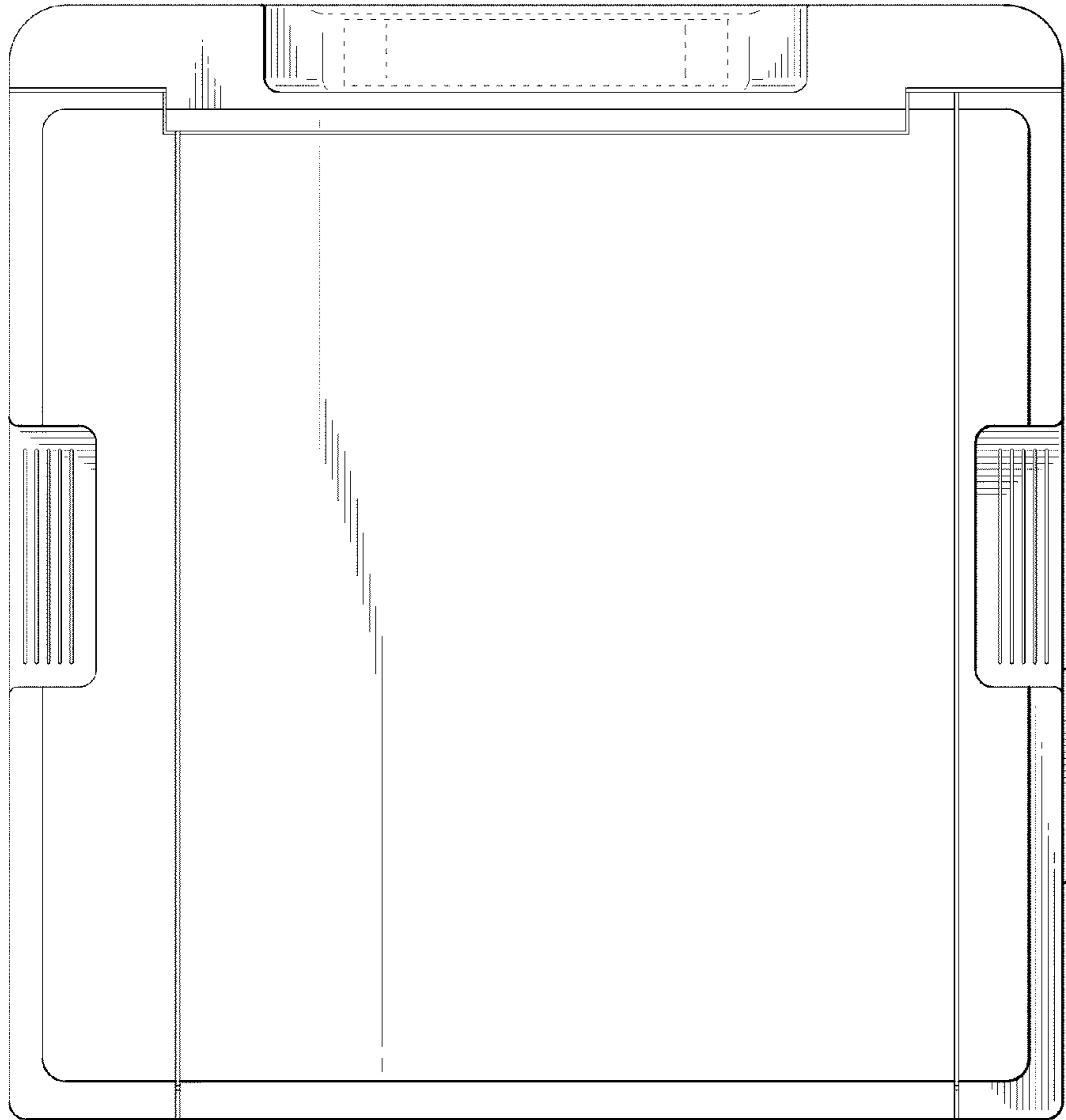

FIG. 7